



International Society
for Gastrointestinal Hereditary Tumours



7TH BIENNIAL *meeting*

Abstract Book



FLORENCE 2017

OCO3 - COMPREHENSIVE POPULATION-WIDE DETECTION OF LYNCH SYNDROME IN ICELAND

S. Haraldsdottir¹, T. Rafnar², W. L. Frankel³, S. Einarsdottir⁴, A. Sigurdsson², H. Hampel³, P. Snaebjornsson⁵, G. Masson², D. Weng³, B. Kehr², A. Yilmaz³, S. Haraldsson⁶, P. Sulem², T. Bekaii-Saab³, M. Hitchins⁷, C. C. Pritchard⁸, A. de la Chapelle³, J. G. Jonasson⁹, R. M. Goldberg³, K. Stefansson²

¹Department of Internal Medicine, Division of Medical Oncology, Stanford University Stanford, ²deCODE Genetics Reykjavik, ³The Ohio State University Comprehensive Cancer Center Columbus, ⁴Aalborg Universitets Hospital Aalborg, ⁵Netherlands Cancer Institute "Antoni van Leeuwenhoek Amsterdam, ⁶Hvidovre Hospital Hvidovre, ⁷Stanford University Stanford, ⁸University of Washington Seattle, ⁹Landspítali University Hospital Reykjavik

Background

Lynch syndrome (LS) is caused by germline mutations in the mismatch repair (MMR) genes (*MLH1*, *MSH2*, *MSH6*, *PMS2*) or *EPCAM*, and is associated with increased cancer risk. The incidence of LS in Iceland is unknown. We investigated the incidence of LS and etiology of MMR deficiency (dMMR) by screening all Icelandic individuals diagnosed with colorectal cancer (CRC) over a decade for dMMR and correlated the results with complete information on LS gene variation and cancer incidence.

Methods

Immunohistochemistry (IHC) for *MLH1*, *MSH2*, *MSH6*, and *PMS2* was performed on all CRC cases diagnosed from 2000-2009 in Iceland. Cases with *MLH1*/*PMS2* deficient tumors underwent *MLH1* hypermethylation (*MLH1*-hm) testing. Information on MMR gene variation in the Icelandic population was extracted from a genetic database. Germline genotyping was done on peripheral blood mononuclear cells obtained from all patients with dMMR tumors and 78.2% of patients with MMR proficient tumors. All unexplained dMMR cases underwent whole-genome sequencing and tumor ColoSeq to identify somatic MMR mutations.

Results

Of 1182 patients (97.8%) with tumor available for MMR IHC, 132 (11.2%) had dMMR. Ninety (7.6%) dMMR cases were *MLH1*-hm, 21 (1.8%) had LS and 16 (1.4%) double somatic MMR mutations. Overall, LS accounted for 2.3% of all CRCs. Two mutations, *MSH6* p.*Leu585Pro* and *PMS2* p.*Pro246Cysfs*3*, caused 77.8% of LS in CRC patients. Three CRC patients had private mutations in *MSH6* and one patient had an interchromosomal translocation in *MLH1*. Three founder mutations, *MSH6* p.*Leu585Pro*, *PMS2* p.*Pro246Cysfs*3*, and *PMS2* p.*Met1?* had a combined population frequency of 0.442%, affecting 1 in 226 individuals and displayed odds ratios of 10.1, 3.6 and 2.2 for CRC, respectively. Thirteen MMR variants of unknown significance (VUS) in the population were not associated with increased cancer risk.

Conclusions

Founder mutations in *MSH6* and *PMS2* prevail in Iceland. Only one case each of *MLH1* and *MSH2* mutations occurred. The LS population incidence of 0.442% is the highest ever reported but given the lower cancer penetrance linked to *MSH6* and *PMS2*, only 2.3% of CRC are caused by LS. The *MSH6* p.*Leu585Pro* mutation can be reclassified as a pathogenic mutation and 13 MMR VUS can be reclassified as benign.

OCO4 - LAPAROSCOPIC COLECTOMY AND ILEORECTAL ANASTOMOSIS AS PROPHYLAXIS FOR FAMILIAL ADENOMATOUS POLYPOSIS IS ASSOCIATED WITH REDUCED POSTOPERATIVE DESMOID RISK

A. Sinha¹, E. Burns¹, A. Latchford¹, S. Clark¹

¹Polyposis Registry, St Mark's Hospital London

Introduction

Laparoscopy is increasingly used in prophylactic surgery for patients with familial adenomatous polyposis (FAP) undergoing colectomy with ileorectal anastomosis (IRA). Little is known about the impact of the use of laparoscopy on the postoperative desmoids tumour (DT) risk.

This study aimed to establish the postoperative DT rate amongst patients undergoing laparoscopic and open IRA.

Methods

Patients with FAP and known germline *APC* mutation who underwent primary IRA between 1996 and 2016 were identified from a prospectively maintained polyposis registry. Only patients with follow up at our institution were included. Data pertaining to patient demographics, genotype, family history (FH) of DT, the surgical approach at IRA, and postoperative complication were collected. Mutations 3' to codon 1399 were considered predictive of DT risk. Conversions from laparoscopic to open surgery were considered in the open group.

The study end point was the postoperative development of clinically significant DT. This outcome was defined as a symptomatic or radiologically detected intra-abdominal or abdominal wall DT. Patients were censored at the time of first detection of DT or last clinical follow up. Fisher's exact test and Kaplan Meier survival analysis were used.

Results

One hundred and twelve patients underwent an IRA; 69 (61.6%) were completed laparoscopically. The median follow up was 5.8 years [Interquartile range(IQR) 2.4 years to 11.2 years]. Ten patients developed intra-abdominal or abdominal wall DT. The median time from surgery to development of DT was 3 years (IQR 1.5 years to 4.7 years). No significant differences were detected in terms of gender, genotype or positive FH between the laparoscopic and open groups.

Patients managed laparoscopically had a reduced postoperative DT rate [Open 7/43 (16.3%) Laparoscopic 3/69 (4.3%), $p=0.043$ (table 1)]. This did not reach significance on Kaplan Meier analysis (Figure 1, Log rank $p=0.223$).

Conclusions

These data suggest that laparoscopic surgery is safe and maybe associated with a reduced DT risk in patients with FAP undergoing IRA.

Table 1		Postoperative DT	n	DT rate (%)	p value
Gender	Male	2	51	3.9	
	Female	8	61	13.1	0.108
Family History of desmoid	No	6	102	5.9	
	Yes	4	10	40.0	0.005

Desmoid prone mutation	No	6	103	5.8	
	Yes	4	9	44.4	0.003
Return to theatre	No	10	0	9.5	
	Yes	0	7	0	1.000
Laparoscopic approach	Open	7	43	16.3	
	Laparoscopic	3	69	4.3	0.043



OCO7 - REACTIONS AND ATTITUDES TOWARDS A LETTER WITH UNSOLICITED RISK INFORMATION

H. V. Petersen¹, C. K. Lautrup², L. J. Lindberg¹, S. Ladelund¹

¹The Danish national HNPCC register, Clinical Research Center, Copenhagen University Hospital, Hvidovre, Denmark Hvidovre ,

²Department of Clinical Genetics, Aalborg University Hospital, Denmark Aalborg

Background

Since 1997 the Danish national HNPCC register has had permission to directly approach individuals at potentially high risk of hereditary colorectal cancer. Individuals at risk are identified through family members and the Danish National Population Register. Before sending out letters with risk information, probands are encouraged to inform other family members about risk and that they will receive a letter with information and invitation to genetic counselling.

To the best of our knowledge Denmark is the only country with 20 years of clinical experience in sending out unsolicited letters to individuals at potential risk of hereditary cancer.

The aim of the study was to examine how individuals from families with Lynch syndrome (LS) and families with high risk of familial colorectal cancer (FCC, former Amsterdam I and II) have experienced receiving unsolicited risk information. We also examined current attitudes toward directly approaching individuals at high risk.

Method

A four page questionnaire was developed based on a pilot study with qualitative interviews of 10 individuals who had received an unsolicited letter with risk information within the past eight years.

From 2008 to 2015 the Danish HNPCC register send letters with risk information to 1278 individuals at potential risk. A random selection of 50 individuals from LS families and 50 from FCC families from each year was performed if possible. A total of 708 were invited to participate in the study.

Results

The response rate was 56% including 396 individuals of which 197 (50%) were women. 190 (48%) came from FCC families. Mean age of responders were 56 years (45-67). Before receiving the letter with risk information 44% were informed it would come and 47 % knew about their risk.

The majority of the responders did not experience negative feeling when they received the letter with risk information. Less than 20 % stated they were shocked and 5% felt angry.

Almost 80% of the responders had positive attitudes toward the direct approach. Only 2.5 % did not want any kind of risk information and 90 % preferred receiving a letter to not getting any information about potential risk. Most informants found it important to inform their children themselves. However, 66 % still wanted their children to receive a letter with risk information from the age of 18 years.

Conclusion

The majority of the responders did not experience negative feelings when receiving an unsolicited letter with risk information directly from the HNPCC register and their current attitudes toward the direct approach were positive.

OCO9 - HUMAN INTESTINAL ORGANOIDS AS A MODEL TO STUDY LYNCH SYNDROME MUTATIONS

C. Heinen¹, B. Lin¹, A. Rath¹

¹UConn Health Farmington, CT

Lynch syndrome (LS) is an autosomal dominant hereditary disorder that predisposes patients primarily to colorectal cancer. LS is caused by germline mutations in one allele of a DNA mismatch repair (MMR) gene and subsequent loss of the remaining wild-type allele in an intestinal cell likely precedes development of the tumor. How loss of MMR function enhances tumorigenesis is still not fully understood, though this knowledge would be useful for improving the prevention or treatment of these cancers. A hurdle to accomplishing this goal has been the lack of a suitable model system for studying the effects of MMR loss in human intestinal cells. Recent advancements in the creation of human intestinal organoids (HIOs) either through directed differentiation of human embryonic stem cells or through isolation and culture of human intestinal crypts may provide a new model system for studying the biology of human intestinal cells. We have generated HIOs from wild-type human embryonic stem cells as well as from cells in which we have knocked out the endogenous *MSH2* MMR gene using CRISPR/Cas9 gene editing. Using these HIOs, we have examined the response of intestinal cells to DNA alkylation damage in the presence or absence of functional MMR. We have shown that intestinal cells in the HIOs can activate a MMR-dependent apoptosis as well as a novel senescence response to this DNA damage. We also created HIOs from adult human colon tissue samples and demonstrated similar apoptotic and senescent responses to DNA damage in the adult tissues indicating that the MMR pathway plays an important role in eliminating damaged intestinal cells to prevent tumorigenesis. We propose that loss of MMR function in LS patients would lead to a selective advantage that may be important during the early stages of tumorigenesis in these patients. In summary, we believe that HIOs provide an exciting new model system for studying the effects of LS mutations in the MMR genes in human intestinal cells and are also utilizing this system to study the functional effects of variants of uncertain significance in MMR genes in suspected LS patients.

OC10 - MANAGEMENT OF GASTRIC ADENOMAS IN PATIENTS WITH FAMILIAL ADENOMATOUS POLYPOSIS

I. Martin¹, V. Roos², S. Walton¹, C. Anele¹, V. Cuthill³, N. Suzuki⁴, B. Bastiaansen⁵, E. Dekker⁶, A. Latchford¹, S. Clark¹, A. von Roon⁷
¹Polyposis Registry, St. Mark's Hospital London, ²Dept. Gastroenterology & hepatology, Academic Medical Centre Amsterdam, ³Polyposis Registry, St Mark's Hospital London, ⁴Endoscopy St. Mark's Hospital London, ⁵Gastroenterology Oncology, Academic Medical Centre Amsterdam, ⁶Gastrointestinal Oncology, Academic Medical Centre Amsterdam, ⁷Department of Cancer and Surgery, Imperial College London London

Background

Patients with familial adenomatous polyposis (FAP) are known to be at elevated risk of developing gastric adenomas and cancer. There is limited understanding of their clinical course and no consensus on surveillance and management. We reviewed the management of gastric adenomas in patients with FAP from two centres.

Methods

Patients were identified from registry databases. Endoscopy and histopathology reports were evaluated, as well as patient records.

Results

Of 718 patients, 89 (40 female) had gastric adenoma (prevalence 14.4%). Median age at diagnosis was 46 years (range 19-80) and median follow-up 18 months (range 1-123).

Adenomas ranged in size from 2mm to 50mm. Eighteen (20%) patients had adenomas <5mm and 7 (8%) patients had adenomas >20mm. Forty-five (51%) patients had multiple adenomas and of these 33 (75%) patients had adenomas only located distal to the incisura.

Five (6%) patients had adenomas containing high-grade dysplasia, all of which were solitary and ranged widely in size (7-50mm).

30/89 (34%) underwent therapy, 22 (25%) are awaiting intervention with 36 (40%) remaining on surveillance and 1 lost to follow up. Eighteen patients (20%) underwent EMR, five (6%) had ESD, five (6%) had snare polypectomy, one had a cold biopsy and one underwent PPPD for duodenal disease revealing an incidental finding of a gastric adenoma on histology. Of those undergoing intervention, three (10%) were admitted for complications – one for bleeding following ESD, requiring repeat endoscopy and two for analgesia following EMR.

Three patients had a recurrence, two following piecemeal EMR of LGD lesions and one following ESD of a lesion with HGD, who proceeded to subtotal gastrectomy. There were five deaths (6%), one (1%) from gastric cancer (T2N2M1 non treated lesion), two (3%) from unknown primary tumours, one from desmoid disease, and one from biliary sepsis.

Conclusions

Gastric adenomas were seen in 14% of our cohort. Endoscopic resection of gastric adenomas is safe with a low incidence of recurrence. Gastric adenomas seem to be distributed equally proximal and distal to incisura. Guidelines for endoscopic surveillance and management of gastric adenomas in FAP are required.

Keywords: Gastric adenoma, stomach neoplasm, Familial adenomatous polyposis

OC11 - POUCH POLYPS IN FAP – A CLINICAL PROBLEM OR AN ENDOSCOPIC CURIOSITY?

N. R. O'Shea¹, N. C. Hodges¹, R. F. S. Man¹, S. K. Clark¹, A. C. Von Roon², A. R. Latchford¹

¹St Mark's Hospital London, ²Imperial London

INTRODUCTION:

Restorative proctocolectomy (RPC) is one of the surgical options for patients with Familial Adenomatous Polyposis (FAP). Current guidelines suggest annual endoscopic pouch surveillance as formation of adenomas and carcinomas have been reported, however the data are few and the clinical impact of these not well established.

METHODS:

We identified all FAP patients with a pouch undergoing surveillance at our institution and retrospectively analysed our prospectively maintained polyposis database. Demographic data, details of surgery, original histopathology and follow-up pouch endoscopy reports and pathology findings were obtained.

RESULTS:

We identified 388 patients with FAP who had undergone pouch surgery from 1978 to May 2016; 260 had endoscopic follow-up at our institution. 131 (50%) were male. At the time of analysis, the median age was 47 years (range 7-85), and median pouch age was 15 years (range <1-35).

Adenomatous polyps were found in 77% (200) of the ileoanal pouches. 53% (138) had cuff and 64% (166) had ileal pouch body adenomas. The time to first polyp formation was not significantly different between cuff (median 6, range 1-30 years) and pouch body (median 6, range 1-24 years), $p=0.11$. Pouch body adenomas developed in 47% (49/104) at 10 years and 65% (36/55) by 20 years. Cuff polyps were seen in 24% (25/104) and 27% (15/55) at 10 and 20 years respectively. The polyp count range per patient was 1-50 and 1-500 for cuff and pouch body polyps respectively.

12% (30) of cuff polyps and 5% (12) of pouch body polyps were >1cm in size; range 10-60mm (median 20mm) in the cuff and 15-40mm (median 25mm) in the pouch body. 82% of the polyps >1cm were treated with 1-7 (median 1) endoscopic mucosal resections. 14 patients (5%) required at least one examination under general anaesthesia for assessment and polyp resection. Pouchectomy was performed in 3% (7) for endoscopically unmanageable polyps.

High grade dysplasia / adenocarcinoma was identified in 3 cuff polyps at 4, 13 and 17 years following pouch formation; Pouchectomy was performed in all 3 cases. No pouch body cancers were identified.

CONCLUSIONS:

Adenomatous polyps are common in the cuff and pouch body following RPC in FAP patients. The risk of cuff and pouch body polyps increases with pouch age. Large pouch polyps often require

recurrent endoscopic intervention and surgery is indicated if endoscopic removal is not feasible.
High quality endoscopic surveillance is mandated.

OC12 - RISK OF METACHRONOUS COLORECTAL CANCER FOLLOWING COLECTOMY IN LYNCH SYNDROME: A SYSTEMATIC REVIEW AND META-ANALYSIS

C. Anele¹, S. Adegbola¹, A. Askari¹, A. Rajendra¹, S. Clark¹, A. Latchford¹, O. Faiz¹

¹St Mark's Hospital and Academic Institute London

ABSTRACT

AIM:

Extended colectomy (EXTC) in Lynch syndrome (LS) has been recommended to reduce the risk of metachronous colorectal cancer (mCRC). There is limited evidence comparing the risk of mCRC following segmental (SEGC) and EXTC. The objective of this systematic review is to evaluate the risk of developing mCRC following SEGC and EXTC for LS CRC

METHOD:

A systematic review of major databases was performed using predefined terms. Articles published in English language between 1950 to January 2016 were included. Studies which reported CRC in LS patients who underwent surgical resection or colectomy (segmental, subtotal or total) and subsequent development of mCRC were included. Studies were included if the patients had proven germline mutation in *MLH1*, *MSH2*, *MSH6* or *PMS2* or the epi-mutation in *EPCAM*.

RESULTS

The search retrieved 324 studies. Six studies involving 871 patients met the inclusion criteria. The average age at the index operation was 36.4 years and 35.1% of subjects were male. 705 (80.9%) underwent SEGC and 166 (19.1%) EXTC. Median follow-up was 91.2 months. mCRC rate was 22.8% and 6% in the SEGC and EXTC groups respectively. Patients in the SEGC group were four times more likely to develop mCRC (OR 4.02, 95% CI: 2.01-8.04, p<0.0001).

Endoscopic follow-up was reported in three of the six studies. Two reported mCRC rates of 77.2% and 78.9% in patients undergoing one-two yearly surveillance.

In the third study, two of the 8 mCRC in the SEGC group were diagnosed in patients who developed symptoms less than a year after a normal colonoscopy. The remainder developed in patients who had defaulted colonoscopic surveillance for at least two years. In the EXTC group, one mCRC developed one year after a normal surveillance sigmoidoscopy and the other in a patient who had defaulted surveillance sigmoidoscopy for 4 years.

CONCLUSION:

This result suggests that EXTC reduces the risk of mCRC by over four fold compared to SEGC. mCRC occurred in the SEGC group despite postoperative endoscopic surveillance. Most of the patients were *MLH1* or *MSH2* mutation carriers and the risk appeared to be higher in this group. We recommend that risk of mCRC should be considered when deciding the appropriate surgical management of LS patients with CRC. More studies are needed to evaluate the risk of mCRC in the individual MMR gene mutation and quality of life between the two groups.

OC13 - QUALITY OF LIFE ASSOCIATED WITH DESMOID TUMOURS

S. Walton¹, R. Man¹, S. K. Clark¹

¹The Polyposis Registry, St Mark's Hospital London

Introduction

QOL assessment tools can help guide patients and healthcare professionals when considering potential interventions. Little has been reported on health-related quality of life (QOL) associated with desmoid tumour occurrence in patients with FAP. The aim of this study was to assess the impact of desmoid tumours on QOL in patients with FAP.

Methods

There were two parts to the study: a desmoid patient focus group discussion to elicit QOL issues and a questionnaire study utilising two validated tools (SF-36 and EQ5D-5L). These were completed by patients with and without desmoid either via post or in the clinic.

Results

Twelve patients with a desmoid tumour participated in the discussion group and 70 patients with FAP (32 with and 38 controls without desmoid) completed the questionnaires. There was no significant difference in gender distribution, age, marital or employment status between those with and without desmoid. The EQ5D-5L questionnaire found a reduction in one of five QOL domains. Activity was lower in the desmoid tumour group (38%) compared to controls (16%) ($p=0.05$). The SF-36 questionnaire found patients with a desmoid had significantly reduced QOL in the following domains compared to those without a desmoid: bodily pain ($p=0.01$), role physical ($p=0.0003$), vitality ($p=0.004$) and general health perception ($p=0.02$). The themes generated from the focus group discussion on impact of desmoid included cosmetic appearance, importance of family support, the lack of information and medical knowledge available for patients and the unpredictable nature of their condition.

Conclusion

In patients with FAP, desmoid tumours significantly impact on health-related QOL. They can limit physical and social activity and are a source of pain. Patients feel information regarding their condition is limited and recognise health professionals' lack knowledge in this area, reflecting the rare nature of these tumours. These are QOL issues unique to patients with FAP and desmoid and it is now time they were further explored to develop a desmoid-specific quality of life assessment tool that could help to evaluate potential treatment options.

OC14 - OUTCOMES OF SMALL INTESTINAL TRANSPLANT FOR DESMOID TUMOUR

S. Walton¹, S. Middleton², P. Friend³, A. Butler², A. Vaidya³, S. Reddy³, S. Clark¹, S. Gabe¹

¹The Polyposis Registry, St Mark's Hospital London, ²Cambridge Transplant Centre, Cambridge University Hospitals NHS Foundation Trust Cambridge, ³Oxford Transplant Centre, Oxford University NHS Trust Oxford

Introduction

A minority of intra-abdominal desmoid tumours grow relentlessly, leading to small bowel obstruction, perforation and mesenteric vessel tumour encasement. Surgery in these cases can be hazardous, resulting in extensive small bowel resection and long-term parenteral nutrition (PN) requirement. Small bowel transplant (SBT) has become part of the treatment pathway in for their management. The aim of this study was to review the outcomes of patients undergoing SBT for desmoid at 2 intestinal transplant centres in the UK.

Methods

All patients who had SBT for complications arising from desmoid tumours were identified from the UK National Adult Small Intestinal Transplant (NASIT) database and their medical notes interrogated. Data collected included PN requirement and associated complications, indication for SBT, timing from referral to surgery, length of hospital stay, SBT complications and survival.

Results

A total of 8 people underwent SBT for desmoid from 1993-2014. Seven had FAP and one had a sporadic tumour. Pre-operatively, all patients had significant pain, reduced physical activity, nutritional difficulties (6 required PN) and were unable to work. In 3 cases a SBT was undertaken for chronic bowel obstruction and 5 for short gut. The median time interval from referral to surgery was 9.2 months (range 2.5-17.8). SBT grafts included: 4 multivisceral, 3 small bowel only and 1 small bowel with abdominal wall. Median hospital stay was 40 days (range 37-261). Early complications included bleeding, chylothorax, renal impairment and chest infection. There were no peri-operative deaths. Three patients experienced graft rejection: 1 had a second SBT within seven months and 2 died at 27 and 64 months after surgery. A further patient died 71 months after SBT from an unrelated cause. Five out of 6 patients no longer required PN following surgery. Five patients remain well following their SBT with improved functional status. The overall 3YSR following SBT was 83%, with a median follow-up of 40.4 months (IQR 21.8-67.6). A desmoid recurred in the abdominal wall in 1 patient.

Conclusion

This study supports the use of SBT for complicated desmoid tumours and provides important data on outcomes for patients and clinicians contemplating it. More information is required on the quality of life associated with SBT surgery in this rare patient cohort.

OC16 - UPTAKE OF GENETIC TESTING BY THE CHILDREN OF LYNCH SYNDROME PATHOGENIC VARIANT CARRIERS ACROSS THREE GENERATIONS

T. Seppälä¹, K. Pylvänäinen², J. Mecklin²

¹Abdominal Surgery, Helsinki University Hospital Helsinki, ²Education and Science, Central Finland Central Hospital Jyväskylä

Importance The majority of Lynch syndrome carriers are not identified for several reasons, and possibilities of early cancer detection and prevention are missed.

Context Lynch syndrome is the most common autosomal-dominantly inherited disorder that predisposes to variety of malignancies, most likely colorectal and endometrial cancer, at high probability. Tested probands are supposed to inform their relatives about cancer risk and option to receive genetic counseling followed by predictive gene testing, but many at-risk relatives fail to eventually undergo testing.

Objective To assess uptake of predictive testing in a large national database of Lynch syndrome mutation carriers and their direct offspring.

Design Cross-sectional registry-based cohort study

Setting Finnish Lynch syndrome registry

Participants 1184 Lynch syndrome mutation carriers and their 2068 biological children

Main Outcome Measures The uptake of predictive testing and demographic factors influencing this decision.

Results 1184 tested mutation-positive probands had 2068 children that were divided in three generations: 660 parents and 1324 children in first, 445 and 667 in second, and 79 and 77 in third generation, respectively. Of those over 18 years old, 801 (67.4%), 146 (43.2%) and 5 (23.8%) children were genetically tested in each generation, respectively. Together, 539 first generation mutation carriers had 2068 children and grandchildren (3.84 per carrier). Of the 1548 (2.87 per carrier) eligible children, 952 (61.5%) were tested (1.77 per carrier). In multivariate model, age (OR 1.08 per year; 95% confidence interval 1.06-1.10), family gene (OR 2.83; 1.75-4.57 for *MLH1* and 2.59; 1.47-4.56 for *MSH2* compared to *MSH6*), one or more tested siblings (OR 6.60; 4.82-9.03), no siblings (OR 4.63; 2.64-8.10) and parent under endoscopic surveillance (OR 5.22; 2.41-11.31) were independent predictors of having genetic testing. Parent having died or had cancer was more common among those that underwent genetic testing.

Conclusions and relevance Example of parents to adhere to regular surveillance and siblings to have genetic testing are strong influence to children at 50% risk of Lynch syndrome to have predictive gene testing. Number of untested, adult at-risk individuals is high even among well-established cohort of known Lynch syndrome families with good adherence to endoscopic surveillance.

Conflicts of interest: None

Figure legend: Number of children of each generation grouped by age.

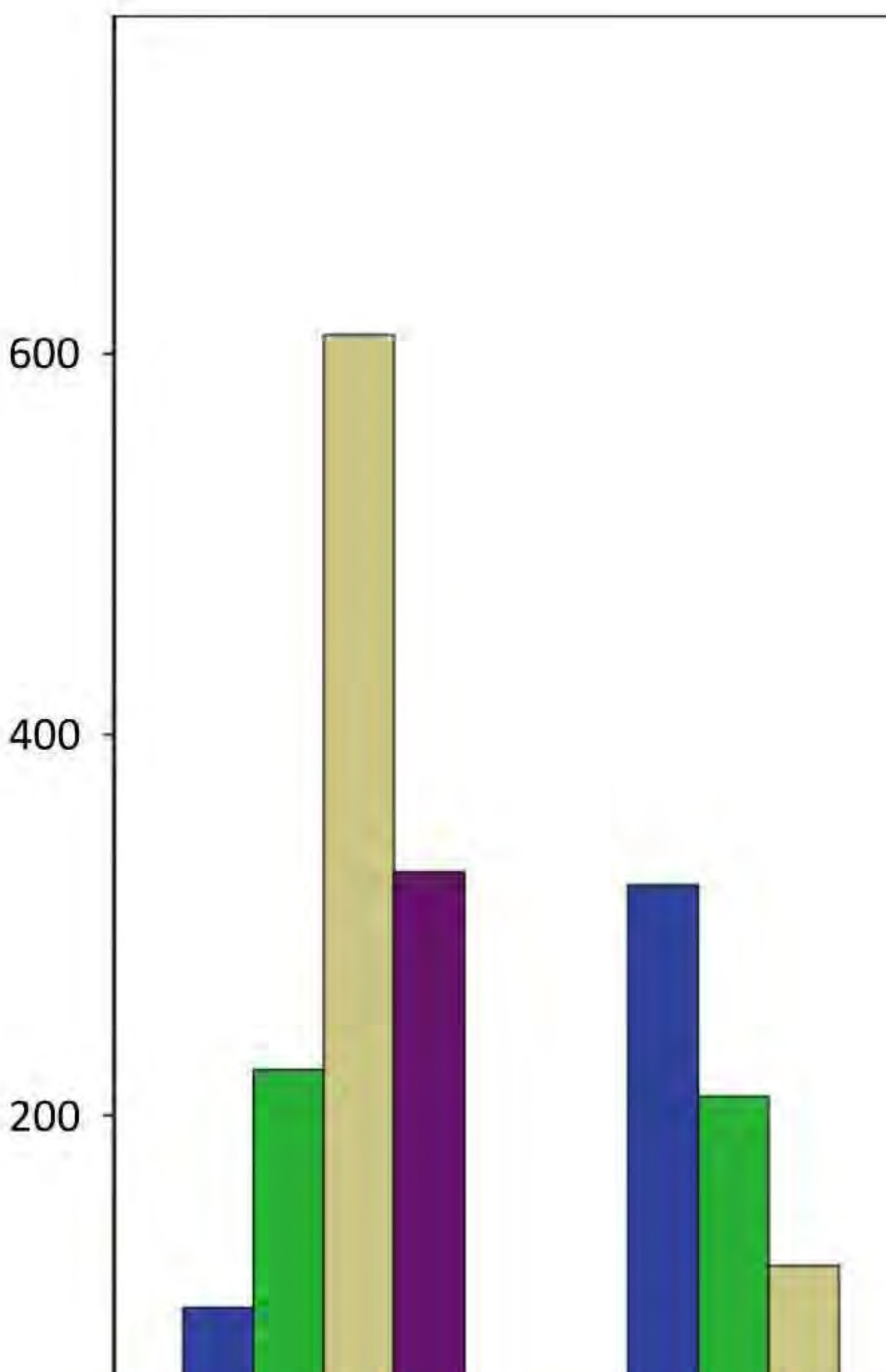

OC18 - CALIBRATING AN IN VITRO FUNCTIONAL ASSAY FOR THE DIAGNOSIS OF MISSENSE VARIANTS IN MISMATCH REPAIR GENES IN LYNCH SYNDROME

M. Drost¹, N. de Wind¹, Y. Tiersma¹, B. A. Thompson², D. E. Goldgar², A. B. Spurdle³, M. S. Greenblatt⁴, S. V. Tavtigian²

¹Leiden University Medical Center Leiden, The Netherlands, ²University of Utah Salt Lake City, UT, USA, ³QIMR Berghofer Medical Research Institute Queensland, Australia, ⁴University of Vermont College of Medicine Burlington, VT, USA

In many suspected Lynch syndrome (LS) patients genetic diagnosis is complicated by the discovery of a variant of uncertain significance (VUS). In the absence of sufficient clinical data, it is difficult to interpret their pathogenicity. Therefore, there is a need for convenient functional assays for the assessment of MMR gene VUS. Here we describe the calibration of a functional assay, the CIMRA (Cell-free, In vitro MMR Activity Assay), for diagnosis of MMR gene VUS.

We tested MMR function of 98 MMR gene missense variants using the CIMRA assay, that were classified by the InSiGHT Variant Interpretation Committee as either pathogenic or neutral without functional assay data. We performed logistic regression of CIMRA activities versus odds favouring pathogenicity. This gave a regression equation that converts CIMRA activity to odds in favour of pathogenicity, allowing integration of data with computational-based prior probabilities.

Of 70 variants classified as pathogenic by other evidence, CIMRA activity was <25% of wt in 56/70, 25-50% of wt in 9/70, and >50% of wt in 5/70. Combining CIMRA with prior probabilities of pathogenicity from *in silico* analysis corroborated the assessment of 60/70 as pathogenic; 9/70 were classified as “Uncertain”; and 1/70 resulted in a discordant classification of “likely neutral”. Of 28 variants classified as neutral by other evidence, CIMRA activity was >50% of wt in 27/28 and <50% of wt in 1/28. Combining CIMRA with prior probability of pathogenicity from *in silico* analysis corroborated the assessment of 21/28 neutral variants; 6/28 were classified as “Uncertain”; and 1/15 resulted in a discordant classification of “likely pathogenic”. CIMRA alone had a AUC of the ROC curve of 0.999. Combining CIMRA with *in silico* analysis to form a two-component classification had a AUC of the ROC curve of 0.987, PPV was 0.984 and NPV was 0.955, sensitivity was 0.98 and specificity was 0.96.

The CIMRA assay has strong predictive value and can be used as a tool to evaluate missense MMR gene variants for pathogenicity. The assay is scalable and can be used to test large numbers of missense variants. We are further validating the reproducibility of the assay by re-testing several *MSH2* and *MLH1* variants in different laboratories worldwide. We anticipate that this assay will be an important tool for the development of a comprehensive diagnostic procedure for LS-associated VUS.

OC23 - EMAST INSTABILITY IS A NEW FEATURE OF PANCREATIC CANCER AND IS ASSOCIATED WITH THE HIGH METHYLATOR PHENOTYPE CIMP IN COLON CANCER.

M. Kohonen-Corish¹, S. Meessen¹, N. Currey¹, S. Al-Sohaily¹, A. Australian Pancreatic Genome Initiative¹

¹The Kinghorn Cancer Centre, Garvan Institute of Medical Research Sydney, Australia

Microsatellite instability (MSI) is a well-known marker of Lynch syndrome and sporadic cancers with DNA mismatch repair (MMR) deficiency. Another type of instability, 'elevated microsatellite alterations at selected tetranucleotide repeats' (EMAST), has also been identified in colon and other cancers, but not yet in the pancreas. EMAST has been associated with both MSI-H and MSI-L. One known cause of EMAST is deficiency or dysfunction of MSH3, which is required in the repair of tetranucleotide repeat mismatches, in complex with MSH2. The MSH3 defect may also cause an impairment of homologous repair (HR) and increase sensitivity to some targeted therapies, such as PARP1 inhibitors.

The aim of this study was to establish whether EMAST is present in pancreatic cancer and whether it is associated with high-level gene methylation in colon cancer, using previously validated markers D20S82, D9S242, L17686, UT5320 and MYCL1. EMAST was defined when instability was detected with at least 2 markers compared to matched normal tissue. MSI and the CpG island methylator phenotype (CIMP) were determined with standard marker panels.

In colon cancer, EMAST was present in 28% (30/107) of patients and was strongly associated with CIMP (frequency 13%; $P=0.0002$) and methylation of selected genes, MCC (29%; $P=0.0014$) and p16 (25%, $P=0.0052$), as well as with MSI-H (13%, $P<0.0001$). In the pancreas, EMAST was found in 24% (8/33) of patients, including the only two MSI-H cases ($P=0.06$), but did not show strong correlation with MCC (14%) or p16 methylation (8%). Instability of only one tetranucleotide marker was detected in a further 25% of colon and 52% of pancreatic cancers. This was associated with MSI-L in the colon (14%, $P=0.0022$).

This study has identified instability in tetranucleotide repeats as a common new feature of pancreatic cancer. The strong association of EMAST with CIMP and p16/MCC methylation is also a new finding in colon cancer. Despite close correlation, MSI-H comprised less than half of the EMAST group. This may indicate involvement of non-MMR genes that contribute to maintaining MSH3 expression or its repair functions but are subject to methylation in colon tumours. p16 is a well-known cell cycle regulator and MCC is also emerging as a cell cycle checkpoint regulator and DNA damage repair protein. Further studies are required to establish a functional connection between EMAST, CIMP and p16/MCC deficiency and the implications for therapy.

OC26 - PSYCHOSOCIAL SYMPTOMS IN PATIENTS WITH FAMILIAL ADENOMATOUS POLYPOSIS: HOW A CHRONIC HEREDITARY CANCER PREDISPOSITION SYNDROME AFFECTS MENTAL HEALTH AND BEST PRACTICE FOR PATIENT CARE

L. LaGuardia¹, M. O'Malley¹, M. Kalady¹, E. Wood², J. Church¹

¹Cleveland Clinic Digestive Disease Surgical Institute Cleveland, ²Baylor Psychology Waco

Introduction:

Familial Adenomatous Polyposis (FAP) is a dominantly inherited syndrome of colorectal cancer predisposition, with many other manifestations in other organs. Patients need yearly surveillance of the upper and lower intestine, usually have a major abdominal surgery, and are prone to life altering and sometimes life threatening complications of the disease and its treatment. We wondered how this sort of challenge impacts patients' mental health. We performed this study to find out.

Methods:

A 20 question survey was produced to measure the psychosocial symptoms of patients with FAP. The questions sought to discover which symptoms were most common in this group of patients, and their reaction to the symptoms. The study was approved by the IRBs at the Cleveland Clinic and at Baylor University. Patients were unselected and the survey was sent electronically. Some patients completed paper versions. The responses were completely anonymized.

Results:

There were 79 respondents, 32 men (42.1%) and 40 women (52.6%). All were over age 18 with 36.7% of respondents being between the ages of 45 and 59. Of the 79 patients that completed the questionnaire 57 (72.15%) endorsed one or more psychosocial symptoms related to their FAP diagnosis. The frequency of the symptoms is shown in the table. The number of symptoms per patient ranged from 1 to 17 with a median of 4 symptoms endorsed. Themes from open ended questions were analyzed and coded, revealing trends in coping, psychosocial response, patient support, and general patient experience with FAP. These trends reveal important aspects of patient care that go beyond medical intervention. For example, in response to the question about the availability of psychological support, 6 patients found this in their family, 3 had professional help that was useful, 2 had professional help that was not useful and 39 did not have any support. The most helpful support came from caring doctors (28), family (18), knowing about FAP (8), helping others (8), and God/faith (5). 45 patients found that humor played a role in dealing with their syndrome but 8 did not. 29 patients adopted FAP as part of their identity and viewed it as a strength; 18 did not.

Conclusion: Psychosocial symptoms are common in patients with FAP. Patients cope with them in various ways some of which are more effective than others. Professional counseling, psychoeducation, support networks and access to quality medical care are indicated in providing holistic and comprehensive care to patients with FAP.

OC27 - POST TRAUMATIC STRESS DISORDER IN PATIENTS WITH FAMILIAL ADENOMATOUS POLYPOSIS: A CAUSE FOR CONCERN

M. O'Malley¹, L. LaGuardia¹, M. Kalady¹, E. Wood², J. Church¹

¹Cleveland Clinic Digestive Disease Surgical Institute Cleveland, ²Baylor Psychology Waco

Post-traumatic Stress Disorder (PTSD) can develop after a traumatic event. To meet criteria for PTSD individuals must have experienced an event in which there was actual or threatened serious injury or loss of life. Although physical violence and danger are usually associated with PTSD, medical trauma could also be a trigger. Familial adenomatous polyposis (FAP) guarantees abdominal surgery with the risk of frequent disease and surgery-related complications. Due to the significant medical implications of this disease we hypothesized that FAP could be associated with PTSD. If so, there are implications for patient care.

Methods:

We constructed an anonymized online survey for patients affected with FAP that would measure their mental health. Questions covered the 4 symptoms of PTSD: 1. re-experiencing symptoms, 2. avoiding symptoms 3. hyperarousal symptoms, and 4. negative changes in beliefs and feelings (other psychosocial symptoms). Patients with positive answers to 4/4 were defined as meeting diagnostic criteria for PTSD. Patients with 3 of 4 were deemed "Partial PTSD" due to the limits of the administration of the survey and potential lack of understanding one's psychological responses. Other survey questions were analyzed according to PTSD status. The survey was sent online to all FAP patients enrolled in the Jagelman Registry at the Cleveland Clinic Foundation. In some cases a paper form of the survey was used.

Results: 79 patients completed the questionnaire: 22 patients had no psychosocial symptoms; 57 did (72.2%). 9 patients fitted the definition of PTSD (11.4%) and 8 had partial PTSD (10.1%). Patients with PTSD had an average of 9.3 psychosocial symptoms each, compared to 8.25 for PPTSD and 2.26 for non PTSD designated patients. It is important to note that the two patient groups assigned a PTSD status (PTSD, PPTSD) make up a significant percentage of all endorsed psychosocial symptoms from the total survey sample of 79 patients (table 1.). 6 patients endorsed suicidal thoughts, all of whom met full PTSD criteria.

Conclusion:

Some FAP patients are severely affected by PTSD and need professional counseling. The correlation between FAP patients with PTSD and suicidal ideation is an important point for further exploration and research.

Table 1.

PTSD/PPTSD (n. 17)/ Total Sample(n.79) Symptom %symptoms accounted for by PTSD/ PPTSD patients

8/10 Guilt 80%

3/6 Shame 50%

5/8 Denial 62%

6/6 Suicidal thoughts 100%

10/19 Depression 53%

5/11 Hopelessness 45%

6/8 Isolation 75%

8/15 Stigma or embarrassment 53%

13/33 Anxiety 39%

9/33 Fear 27%

9/26 Body image issues 34%

4/7 Emotional numbing and apathy 57%

8/11 Social anxiety 72%

7/12 Loneliness 58%

5/5 Worthlessness 100%

10/15 Social Withdrawal 67%

6/8 Prolonged Sadness 75%
9/19 Emotional Fatigue 47%
8/21 Feeling overwhelmed 38%
5/10 Extreme stress 50%

OC28 - DUODENAL ADENOMAS IN PATIENTS WITH MULTIPLE COLORECTAL ADENOMAS WITHOUT GERMLINE APC OR MUTYH MUTATIONS

F. Kallenberg¹, A. Latchford², N. Lips¹, C. Aalfs³, B. Bastiaansen¹, S. Clark², E. Dekker¹

¹Department of gastroenterology and hepatology, Academic Medical Center Amsterdam, ²The Polyposis Registry, St Mark's Hospital Harrow, ³Department of clinical genetics, Academic Medical Center Amsterdam

Background and aims: Patients with genetic adenomatous polyposis syndromes have an increased risk for duodenal cancer and clear surveillance recommendations exist for this group. However, limited data are available on the duodenal phenotype of patients with Multiple ColoRectal Adenomas (10-99) without a germline *APC* or *MUTYH* mutation (MCRA). We aimed to assess the frequency, extent and progression of duodenal adenomas in MCRA patients.

Methods: This historical cohort study was undertaken at two polyposis registries: the Academic Medical Center, the Netherlands and St. Mark's Hospital, UK. We collected data on all MCRA patients with an absence of *APC* and *MUTYH* mutations, who underwent at least one esophagogastroduodenoscopy (EGD). Demographic and endoscopic data were collected, described and compared between patients with and without duodenal adenomas.

Results: Eighty-three MCRA patients were identified of which eight (9.6%) had duodenal adenomas, detected at a median of 58 years (range 45-75). Duodenal adenomas were detected in 6/8 patients at first EGD. At diagnosis, all eight patients had Spigelman stage I or II disease and a maximum number of three adenomas. Two of five patients with duodenal adenomas that underwent follow-up EGDs, increased to stage III disease, after 1.1 years and 2.4 years respectively. The other three remained stable, 3.0, 2.8 and 1.1 years after duodenal adenomas were first detected, although two of them underwent duodenal polypectomies. No one developed duodenal cancer or high-grade dysplastic lesions. No differences in demographic and endoscopic data were found between patients with and without duodenal adenomas (**Table 1**).

Conclusion: Duodenal adenomas are found in a minority of MCRA patients, at an average age of 58 years and at diagnosis, disease severity is mild. These results are a first step in unraveling the duodenal phenotype of MCRA, which is needed to provide appropriate upper gastrointestinal screening and surveillance recommendations for these patients.

Table 1. Differences between MCRA patients with and without duodenal adenomas

Patient characteristics (n=83)	Patients with duodenal adenomas (n=8)	Patients without duodenal adenomas (n=75)	P-value
Male gender, n (%)	5 (62.5)	55 (73.3)	0.68 ¹
Median age at baseline EGD (range)	55.9 (44.9-74.8)	60.5 (28.3-83.7)	0.28 ²
Median age at duodenal adenoma detection vs at last EGD for those without duodenal adenomas (range)	58.4 (44.9-74.8)	61.1 (34.2-83.7)	0.27 ²
Median age at MCRA diagnosis (range)	56.3 (44.3-72.7)	58.7 (27.8-83.6)	0.64 ²
Cumulative number of colorectal adenomas at diagnosis of duodenal adenomas vs at last EGD for those without duodenal adenomas, n (%)			1.00 ²
10-30	5 (62.5) ³	44 (58.7)	
31-60	3 (37.5)	25 (33.3)	
61-99	0	6 (8.0) ⁴	
Fundic gland polyps at diagnosis of duodenal adenomas vs at last EGD for those without duodenal adenomas, n (%)	3 (37.5)	10 (13.3)	0.11 ⁴
CRC family history, n (%)	1 (12.5)	20 (26.7)	0.67 ¹
CRC, n (%)	3 (37.5)	13 (17.3)	0.18 ¹

¹ Fisher's exact test with 2-sided P-value; ² Mann-Whitney U test with 2-sided P value; ³Including one patient with 0-5 colorectal polyps at the time of duodenal adenoma detection, who fulfilled MCRA criteria (≥ 10 adenomas) 8.3 years thereafter; ⁴ including one patient with >100 polyps

OC32 - EXTRA-COLONIC CANCER RISK IN APC-ASSOCIATED POLYPOSIS (FAP): LONG-TERM RESULTS FROM THE DUTCH POLYPOSIS REGISTRY

Z. Ghorbanoghl¹, B. A. Bastiaansen², A. M. Langers¹, F. Nagengast³, J. Poley⁴, J. J. Koornstra⁵, S. Sanduleanu⁶, W. H. de Vos tot Nederveen Cappel⁷, B. J. Witteman⁸, H. Morreau⁹, J. C. Hardwick¹, E. Dekker¹⁰, H. F. Vasen¹

¹Gastroenterology & Hepatology Leiden, ²Gastroenterology and Hepatology Amsterdam, ³Gastroenterology and Hepatology Nijmegen, ⁴Gastroenterology & Hepatology Rotterdam, ⁵Gastroenterology & Hepatology Groningen, ⁶Gastroenterology & Hepatology Maastricht, ⁷Gastroenterology & Hepatology Zwolle, ⁸Gastroenterology & Hepatology Ede, ⁹Pathology Leiden, ¹⁰Gastroenterology & Hepatology Amsterdam

Background & Aims: The establishment of polyposis registries and the intensive screening of patients with Familial Adenomatous Polyposis (FAP) have led to a substantial reduction in mortality due to colorectal cancer. Recent guidelines suggest that surveillance of non-intestinal malignancies (e.g. thyroid, pancreas and liver) should also be considered in those patients. However, the value of these surveillance programs is still controversial. In this study, we aim to (1) to assess the occurrence of extra-colonic malignancies and benign tumours in a large series of APC mutation carriers, (2) to evaluate the causes of death in these patients, and (3) to discuss the need for additional surveillance for these malignancies.

Methods & Patients: All FAP-patients with established APC-mutation were selected from the Dutch polyposis registry. Data on age at last follow-up or death, gender and cause of death of patients were collected. Pathology reports were collected from the Dutch Pathology Registry (PALGA). We performed a descriptive analysis of all benign and malignant tumours in these patients.

Results: In a total of 582 FAP-patients with an established APC mutation, 85 extracolonic malignancies were diagnosed in 74 patients. Duodenal, skin and thyroid cancers were the three most prevalent cancers. The main cause of death was cancer (59% of all deaths), with 42% of cancer deaths due to colorectal cancer and 21% due to duodenal cancer. The second and third most common causes of death were cardiovascular disease (13% of all deaths) and desmoid tumours (11% of all deaths), respectively.

Conclusion: Extending surveillance programs from regular colonic and duodenal surveillance to other cancers will not contribute significantly to the survival of patients with FAP. Because the proportion of patients that die from colorectal cancer and duodenal cancer is still substantial, focusing on high-quality surveillance programs at appropriate intervals for the colorectum, duodenum and pouch or rectal remnant after prophylactic surgery will likely contribute to achieve a better outcome for those patients.

OC35 - INCLUDING AMPULLARY POLYPOSIS STAGING IN THE SPIGELMAN CLASSIFICATION: MODIFYING THE MODIFIED

B. Pyle¹, H. Waller¹, T. Chalmers-Watson¹, M. Stevenson², J. Arnold³, S. Parry³, C. Wakeman¹

¹Canterbury District Health Board Christchurch, New Zealand, ²New Zealand Familial Gastrointestinal Cancer Service Christchurch, New Zealand, ³New Zealand Familial Gastrointestinal Cancer Service Auckland, New Zealand

Purpose

Follow up of duodenal polyposis in familial adenomatous polyposis (FAP) is based on the Spigelman Classification. However, assessment of the ampulla is not a specific feature of this classification system and the presence of ampullary disease does not correlate well with the burden of duodenal polyposis. The Spigelman Classification may therefore not accurately predict the risk of developing malignancy of the ampulla. Kashiwagi has suggested a classification system involving the presence or absence of ampullary polyps^{1,2}. We aimed to evaluate whether additional staging of the ampulla would alter follow-up recommendations based on the Spigelman Classification.

Methodology

FAP patients undergoing upper gastrointestinal endoscopy surveillance were identified from the prospectively maintained database of the New Zealand Familial Gastrointestinal Cancer Service (NZFGICS) from June 1995 to February 2016. The duodenal Spigelman score at each procedure was calculated. Patients with ampullary polyps were further classified according to minor or major polyposis as per Kashiwagi. The surveillance interval recommendation according to both of these models was compared. Inappropriate follow up was defined as where the surveillance interval according to the modified Spigelman was longer than that for ampullary classification. Patients identified with inappropriate follow up were then reviewed to identify how the Spigelman classification could be further modified to reduce the discordance in follow up interval with that of the ampullary classification.

Results

35 (21 female) of 116 (30%) FAP patients with duodenal polyps also had ampullary polyps. These patients underwent a total of 75 upper endoscopies. For 43 (57%) of these procedures different follow up intervals resulted when using the Spigelman classification compared with the ampullary classification. For 11 procedures (in 8 patients), all initially classified as Spigelman stage one or two disease, there was a significantly longer surveillance interval (49 months cf 25 months $p < 0.05$). In these 11 procedures incorporating the presence of either minor or major ampullary polyposis^{1,2}, attributing it two points and adding to the Spigelman score, would upgrade the follow up interval to be appropriate for their ampullary polyps.

Conclusion

FAP patients with Spigelman classification stage one and two duodenal polyposis may not have appropriate gastroscopy surveillance recommendations if they also have ampullary disease. Including the presence of ampullary polyposis and attributing it two points in addition to the Spigelman score, ensured that the final score was such that the majority of patients received appropriate follow up for both their duodenal and ampullary disease. This proposal will need further validation with larger databases.

OC36 - HIGH FREQUENCY OF SOMATIC APC MOSAICISM IN PATIENTS WITH GENETICALLY UNSOLVED COLORECTAL ADENOMATOUS POLYPOSIS

G. Piazzì¹, M. Ciavarella², S. Miccoli², A. Prossomariti³, T. Pippucci², E. Bonora⁴, F. Buscherini², F. Palombo², R. Zuntini², T. Balbi⁵, F. Bazzoli³, D. Turchetti², L. Ricciardiello³

¹Center for Applied Biomedical Research (CRBA), S.Orsola-Malpighi Hospital, University of Bologna, Bologna, Italy Bologna, ²Medical Genetics Unit, S.Orsola-Malpighi Hospital, University of Bologna, Bologna, Italy Bologna, ³Department of Medical and Surgical Sciences, University of Bologna, Bologna, Italy Bologna, ⁴Medical Genetics Unit, S.Orsola-Malpighi Hospital, University of Bologna, Bologna, Italy Bologna, ⁵Pathology Unit, S. Orsola-Malpighi Hospital, University of Bologna, Bologna, Italy Bologna

Background and Aim: Familial adenomatous polyposis and MutYH associated polyposis are two inherited syndromes characterized by germline mutations in *APC* and *MutYH* genes, respectively. Recently, germline mutations in *POLE*, *POLD1*, *NTHL1* and *MSH3* genes have been also found in polyposis patients. Somatic *APC* mosaicism has been described in a minority of polyposis patients. However, ~30-50% of colorectal adenomatous polyposis still remains genetically unresolved. Thus, the aim of the present study was to investigate the genetic causes of unexplained adenomatous polyposis.

Methods: Patients with >20 polyps by age 35 years or >50 polyps by age 55 years, no causative germline mutations in *APC* and/or *MutYH*, no family history, were selected from a cohort of 56 subjects with adenomatous colorectal polyposis. To analyze *APC* mosaicism, mutational screening was performed on DNA from adenomas by Sanger or Whole Exome Sequencing (WES). Mosaicism extension to other tissues (peripheral blood, saliva, hair follicles) was evaluated using Sanger sequencing and/or digital PCR. *APC* second hit was investigated in adenomas. WES was performed on DNA from peripheral blood to identify candidate variants for polyposis.

Results: Eight patients were enrolled and *APC* mosaicism was identified in 4 (50%). In three cases it was confined to the gastrointestinal tract, while in one extended also to the saliva. One patient without *APC* mosaicism, who carried an *APC* in-frame deletion (variant of uncertain significance), was found to harbor rare germline variants in *OGG1*, *POLQ* and *EXO1* genes.

Conclusions: Our data show that a relevant percentage (50%) of unexplained polyposis is due to somatic *APC* mosaicism. Importantly, an oligogenic inheritance of rare variants might have a cooperative role in polyposis onset.

Funding: This study was supported by Programma di Ricerca Regione-Università 2010-2012 Regione Emilia Romagna -Bando Giovani Ricercatori "Alessandro Liberati- PRUa1GR-2012-007" to GP; Italian Association for Cancer Research (AIRC) IG Investigator Grant 14281 to LR.

OC37 - MICRORNA-155 IS AFFECTED BY APC MUTATIONS AND CONTROLS CANONICAL WNT SIGNALING IN THE COLON

A. Prossomariti¹, G. Piazzini², L. D'Angelo¹, S. Miccoli³, D. Turchetti³, F. Bazzoli¹, L. Ricciardiello¹

¹Medical and Surgical Sciences, University of Bologna, Bologna, Italy Bologna, ²Center for Applied Biomedical Research (CRBA), S. Orsola-Malpighi Hospital; University of Bologna, Bologna, Italy, Italy Bologna, ³Medical Genetics Unit, S. Orsola-Malpighi Hospital; University of Bologna, Bologna, Italy Bologna

Background/Objectives: Mutations in the APC gene are responsible for the onset of both Familial adenomatous polyposis (FAP) and sporadic colorectal cancer (CRC). MicroRNAs (miRNAs) are small non-coding, single-stranded RNAs that post-transcriptionally regulate gene expression. miR-155 plays a role in WNT signaling, one of the major signaling pathways involved in CRC development, targeting multiple components of the pathway. However, it is unknown whether APC mutations could in turn affect miR-155 expression. The aim of this study was to establish whether APC mutations lead to miR-155 dysregulation in FAP patients and CRC cells and to elucidate the effects of miR-155 on WNT cascade in a context of constitutive WNT signaling activation.

Methods: miR-155-5p levels were measured by quantitative real time PCR (qRT-PCR) in normal mucosa and small colonic adenomas (< 5 mm) of FAP patients (n=6) and CRC cell lines with different APC mutations. AXIN1 and AXIN2 were assayed by qRT-PCR in FAP patients. Healthy subjects (n=5) were used as reference population. Cell counting, colony forming assay and cleaved CASPASE-3 staining were performed to evaluate the effect of miR-155-5p overexpression on cell survival, growth and apoptosis in the APC mutant CRC cell lines SW480 and DLD-1. The effects of miR-155-5p up-regulation alone or in combination with the canonical WNT ligand WNT3a on WNT/ β -CATENIN components were also characterized using western blotting (AXIN1, phospho- β -CATENIN, β -CATENIN, phospho-GSK3 β , GSK3 β and TCF-4) and qRT-PCR (CYCLIND1, C-MYC, AXIN2 and TCF-1), on SW480 and DLD-1 cell lines.

Results: APC mutations were associated with low levels of miR-155-5p in normal mucosa and small colonic adenomas of FAP patients compared with healthy subjects. miR-155-5p down-regulation was also confirmed in the APC-mutant CRC cell lines. Interestingly, mRNA levels of AXIN1 and AXIN2 resulted significantly increased in FAP patients showing reduced expression of miR-155-5p. Induction of miR-155-5p in SW480 and DLD-1 cells was associated with reduced cell survival and clonogenic capability. Moreover, miR-155 transfected DLD-1 displayed increased cleaved CASPASE-3 levels. We also found that miR-155-5p acted as a critical regulator of WNT/ β -CATENIN signaling in the absence of APC, affecting both TCF-4 and AXIN1 proteins and sensitizing CRC cells to WNT3a stimulation.

Conclusions: In APC mutant backgrounds miR155 down-regulation affects Wnt signaling through Axin1. We believe that targeting miR-155 could be a promising strategy for WNT signaling modulation in CRC patients harboring APC mutations.

Funding: This work was supported by Italian Association for Cancer Research [IG14281 to L.R., Fellowship "David Raffaelli" 13837 to A.P.]

OC38 - SURGICAL MANAGEMENT OF SERRATED POLYPOSIS SYNDROME: A MULTI-CENTRE EXPERIENCE

S. Rana¹, J. Ijspeert², N. Atkinson³, Y. van Herwaarden⁴, I. Nagtegaal⁴, S. K. Clark¹, J. East³, E. Dekker², A. Latchford¹

¹St. Mark's Hospital London, ²Amsterdam Medical Centre Amsterdam, ³Translational Gastroenterology Unit Oxford, ⁴Radboud University Medical Center Nijmegen

Introduction

Serrated Polyposis Syndrome (SPS) is associated with an increased risk of colorectal cancer (CRC). Colonic surgery may be required but data about indication, procedure performed, outcomes and surgical decision making are few. We aimed to address this.

Methods

434 patients with SPS were enrolled from nine centres in the UK and Netherlands. Medical charts, pathology and endoscopy reports were reviewed. Surgical resection data and surveillance outcomes were assessed.

Results

A total of 164 (38%) patients underwent colorectal surgery; 114 (70%) for CRC, 31 (19%) for polyp burden and 14 (9%) for unresectable polyps.

Surgery for Cancer

27/114 (25%) patients had colectomy and ileorectal anastomosis (IRA); 87/114 (75%) had a more limited resection. 90% of those undergoing IRA had a diagnosis of SPS at time of surgery compared with 39% of those undergoing limited resections. Fifty eight (50%) patients had a resection for CRC before a diagnosis of SPS was made. Total polyp burden (median 40 v 22.5, $p<0.01$) and proximal polyp numbers (median 20 v 12, $p<0.019$) were significantly higher in those having more extensive surgery. In the limited resection group eight (9%) patients developed metachronous CRC; 3/8 had recorded post-op endoscopic surveillance and 0/8 met SPS criteria at the time of surgery. 3/8 had IRA as management of their second CRC. Median interval to second CRC was 24 months.

7/87 with a limited resection required further surgery (all IRA) for unmanageable polyp load. Total (median 40 v 25, $p<0.01$), proximal (median 25 v 15, $p=0.002$) and larger (>10 mm) polyp (median 10 v 2, $p=0.005$) burdens were higher in this group than those having surgery for CRC alone.

Surgery for High Polyp Burden

All 31 patients had a diagnosis of SPS and underwent IRA. Median polyp count was 43 (IQR 34-56.5) with median proximal polyp count of 31 (IQR 26.8-47.5).

Surgery for Unresectable Polyp

All fourteen patients underwent segmental resection. None have developed CRC. Polyp burden in this group was equivalent to those having CRC surgery.

Conclusion

38% of SPS patients required colorectal resection, mostly for CRC, of whom only half were known to have SPS at the time of surgery. Metachronous CRC is uncommon. Segmental resection and close endoscopic surveillance is appropriate for some. More extensive surgery is needed for those with SPS cancer presenting concurrently with high polyp burden. Surgical decision making should be guided by the endoscopic assessment of SPS.

OC41- COLORECTAL SURVEILLANCE IS ALSO RELEVANT IN FAMILIES WHO DO NOT FULFIL CLASSICAL PHENOTYPICAL CRITERIA

L. J. Lindberg¹, S. Ladelund¹, B. L. Frederiksen¹, L. Smith-Hansen¹, I. Bernstein²

¹Danish HNPCC register, Clinical Research Centre, Copenhagen University Hospital Hvidovre, Denmark, ²Department of Surgical Gastroenterology, Aalborg University Hospital Aalborg, Denmark

Background:

Colonoscopic colorectal surveillance is routinely recommended to individuals at risk in families with Lynch syndrome (LS) and in families with familial colorectal cancer (FCC Type X) defined by fulfilling the Amsterdam criteria and LS being excluded. Members of families not fulfilling the Amsterdam criteria, but suspected of FCC are not routinely offered surveillance in all countries.

The aim of this study was to compare the outcome of colonic surveillance in families with FCC Type X with the outcome of surveillance in families suspected of FCC with different predefined exceptions from the Amsterdam criteria.

Method:

Our study was a prospective, nationwide, observational study on the outcome of 24 years of colonic surveillance registered in the national Danish HNPCC register. We defined three subtypes of suspected FCC: first 'FCC Late onset' by fulfilling the Amsterdam criteria except none affected before the age of 50 years, second 'FCC Type X like' as either missing documentation on one colorectal cancer (CRC), or all affected in one generation, or one affected second degree relative to two first degree relatives, or two CRCs and one advanced adenoma/associated cancer, or only two CRC in a small family, and third 'FCC Grey zone' as FCC otherwise suspected (often because of two exceptions defining 'FCC Type X like' in the same family e.g. one missing documentation and one advanced adenoma plus two CRCs).

Prevalence (first) rounds and incidence (subsequent) rounds were analysed separately.

Results:

We analysed surveillance sessions in different FCC subgroups (9 058), LS (3 590) and moderate familial risk (MFR) of CRC (976), including 20,450 years of follow-up. The outcome of surveillance in FCC Type X, FCC Type X like, FCC Late onset and FCC Grey zone was similar. Incidences of CRC were 0.1–0.4% ($p=0.072$), advanced adenoma were 2.3–3.3% ($p=0.32$), and simple adenoma were 8.4–9.9% ($p=0.43$). The outcome of surveillance in the different subgroups of FCC was different from both LS (Incidence of CRC 2.0%, $p<0.0001$) and MFR (No CRC and only one advanced adenoma).

Conclusion:

Outcome of colonic surveillance is similar in families with different subtypes of FCC, so families suspected of FCC but not fulfilling the Amsterdam criteria should be offered the same surveillance programme as families who do.

OC43 - IDENTIFICATION OF AN ENHANCER REGION FOR THE MLH1 TUMOUR SUPPRESSOR GENE

Q. LIU¹, J. THOMS¹, A. NUNEZ¹, L. HESSON¹, R. WARD², J. PIMANDA¹, M. SLOANE¹

¹Lowy Cancer Research Centre and Prince of Wales Clinical School, UNSW Australia SYDNEY, ²Level 3 Brian Wilson Chancellery, The University of Queensland & Lowy Cancer Research Centre and Prince of Wales Clinical School, UNSW Australia BRISBANE

Lynch syndrome is a familial cancer syndrome characterized by early-onset colorectal and endometrial cancer. It is caused by germline mutations in the DNA mismatch repair (MMR) genes, *MLH1*, *MSH2*, *MSH6* and *PMS2*, with the majority (~ 75 %) of deleterious mutations occurring in *MLH1* and *MSH2*. Germline genetic testing, however, has failed to identify pathogenic mutations in the coding region of an MMR gene in ~ 30 % of patients with a clinical suspicion of Lynch syndrome. The absence of detectable mutations in these cases may be explained by alterations in *MLH1* cis-regulatory elements, which are usually located in introns and intergenic regions. In this study, we describe the first known enhancer region for the *MLH1* gene. Using chromosome conformation capture (3C), we identified a ~1.3 kb region located 35 kb upstream of the *MLH1* promoter that physically interacted with the promoter in cell lines expressing *MLH1* (K562 (myelogenous leukemia) and SW620 (colorectal cancer)). The interaction was lost in the colorectal cancer cell line, RKO, in which *MLH1* is transcriptionally silent. Using chromatin immunoprecipitation (ChIP) we showed that the region showed enrichment of the enhancer mark H3K4me1 only in *MLH1*-expressing cells (K562 and SW620). Enhancer activity was confirmed using luciferase reporter assays in K562 cells. CRISPR-Cas9 mediated deletion of the *MLH1* -35 enhancer in SW620 cells resulted in significantly reduced *MLH1* expression. This study provides the first description of an *MLH1* enhancer that regulates gene activity and identifies a candidate region for further analysis in Lynch syndrome cases.

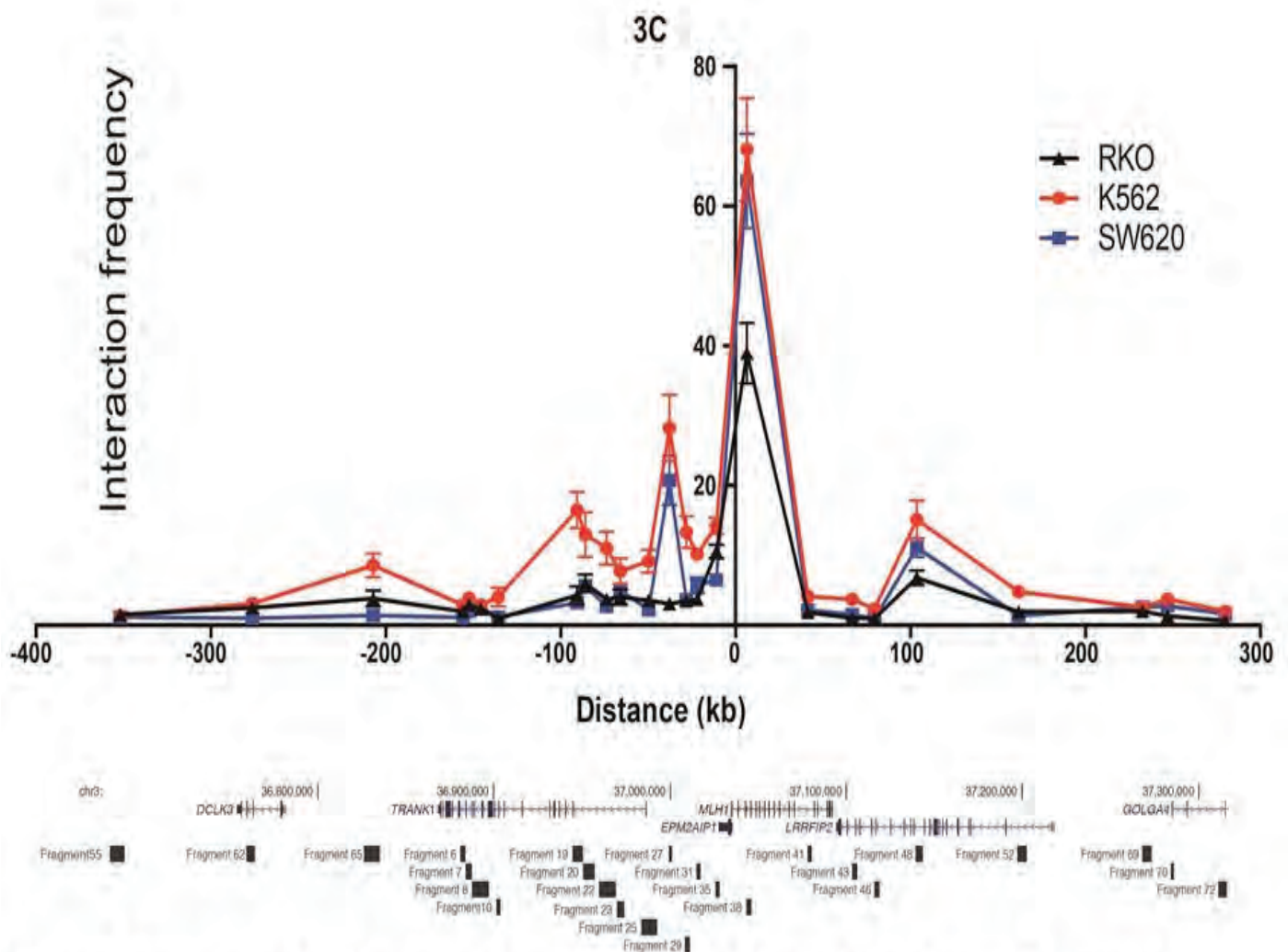

Figure 1. Long-range interactions between the *MLH1* promoter and target fragments measured with 3C-qPCR.

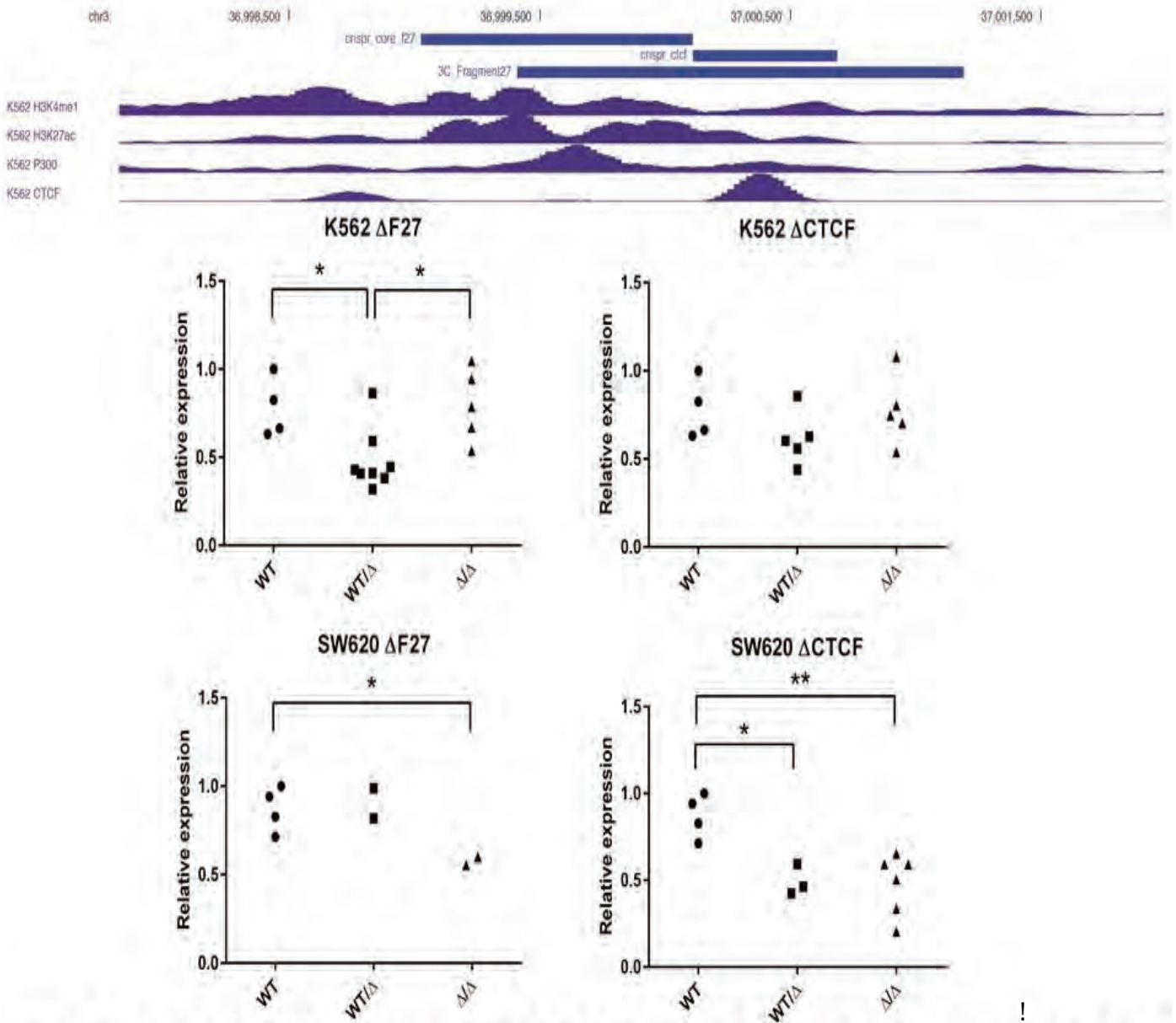

Figure 2. Relative MLH1 expression in K562 and SW620 carrying enhancer deletion mediated by CRISPR-Cas9.

OC47 - SCREENING FOR LYNCH SYNDROME THROUGH THE CANADIAN COLORECTAL CANCER CONSORTIUM

S. Holter¹, A. Pollett¹, C. Brown², D. Schaeffer³, H. Wang⁴, J. Deschenes⁴, W. Foulkes⁵, P. Karanicolos⁶, E. Hsieh⁶, T. Hart¹, C. Streutker⁷, N. Baxter⁷, R. Gryfe¹, S. Gallinger¹

¹Mount Sinai Hospital Toronto, ²St. Paul's Hospital Vancouver, ³Vancouver General Hospital Vancouver, ⁴University of Alberta Edmonton, ⁵McGill University - Genetics Montreal, ⁶Sunnybrook Health Sciences Centre Toronto, ⁷St. Michael's Hospital Toronto

Background: The Canadian Colorectal Cancer Consortium (C4) is a national multi-site collaboration sponsored by the Terry Fox Research Institute. Incorporation of Lynch Syndrome (LS) tumor screening through mismatch repair immunohistochemistry (MMR IHC) into the diagnostic work-up of CRC has become routine. However, there still exist barriers to uptake of genetic counseling and testing, complexity of genetic evaluation, communication of results to at-risk family members and acceptance of surveillance recommendations. **Methods:** Incident CRC cases diagnosed under the age of 60 were approached for consent at six C4 sites across Canada. All consented participants had MMR IHC. Individuals with MMR-deficient IHC were contacted by the study genetic counsellor and offered referral to a genetics clinic for counselling and testing. First-degree relatives (FDR) of all C4 probands were eligible for participation and those consenting provided access to CRC screening and genetic testing records. **Results:** Of 507 participants consented to the C4, 502 have had complete MMR IHC. MMR deficiency was identified in 53 (10.6%) tumors with the majority (54.7%) MLH1 deficient (Figure 1). Germline genetic testing has been completed on 45 (85%) participants while only 3 (5.7%) participants declined genetic counseling or were non-responders. Of the 45 with completed germline analysis, 24 (53%) were found to carry a deleterious MMR mutation and 11 (21%) were identified with MLH1 methylation or biallelic somatic MMR mutations (Figure 2). Time from referral to initial genetic counseling appointment was 58.8 (1-226) days and 103 (30-246) days to germline results appointments. In the 24 confirmed LS families, 129 first-degree relatives were identified; of these 73 were eligible for single-site testing and 57 were deemed ineligible (24 deceased, 11 under age 18, 11 not at-risk parent, 11 out-of-country). Forty-one kin had genetic testing; 26 mutation positive, 13 negative, and 2 pending results. **Conclusions:** Uptake of genetic counseling and testing among individuals with MMR-deficient CRC is high. However, improvement in uptake of genetic testing among family members remains challenging.

Figure 1. Mismatch Repair Deficiency

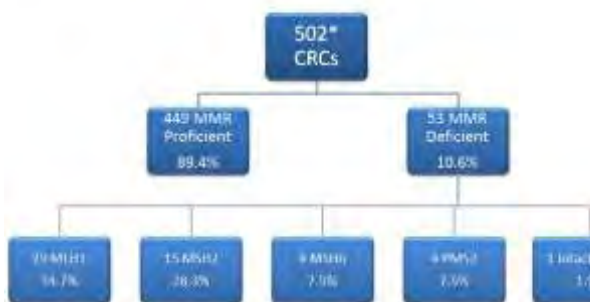

*507 recruited (4 pending MMR IHC, 1 not possible) - January 2017

Figure 2. Mismatch Repair Immunohistochemistry and Germline Analysis

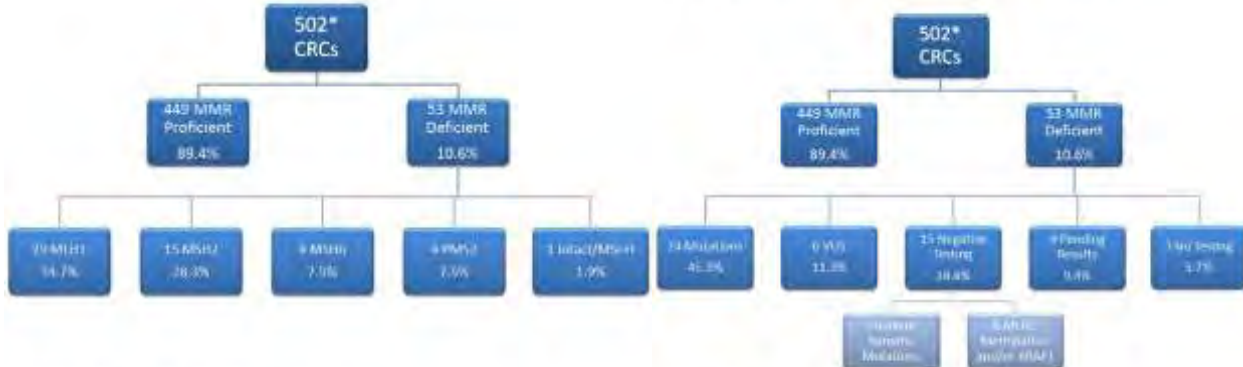

*507 recruited (4 pending MMR IHC, 1 not possible) - January 2017

OC49 - PREVALENCE OF MONO-ALLELIC MUTYH CARRIER STATUS IN PATIENTS OF VARIED ANCESTRIES ASCERTAINED FOR CLINICAL HEREDITARY CANCER RISK TESTING

B. Leach¹, E. Rosenthal², R. Bernhise², K. Brown², H. Goringe², S. Manley²

¹Cleveland Clinic Cleveland, OH, ²Myriad Genetic Laboratories Salt Lake City, UT

Background: Individuals with biallelic pathogenic variants (PVs) in *MUTYH* have a 43-100% lifetime risk for colorectal cancer (CRC) due to the recessive condition *MUTYH*-Associated Polyposis (MAP). Carriers of a single *MUTYH* PV (monoallelic) may have up to a 2-fold increased risk for CRC. The prevalence of monoallelic *MUTYH* PVs in Northern Europeans is estimated to be 1-2%, due primarily to two common founder mutations. We sought to determine the prevalence and clinical presentation of individuals with monoallelic *MUTYH* PVs in other ancestries in order to better estimate the risk for MAP.

Methods: 310,224 individuals were tested with a multi-gene hereditary cancer panel at a commercial testing laboratory. The majority (89.4%) were ascertained for apparent suspicion of hereditary breast and ovarian cancer syndrome (HBOC). All clinical information was obtained from provider completed test request forms.

Results: Monoallelic PVs in *MUTYH* were identified in 1.82% (5,648) individuals. The highest prevalence was in individuals of Asian ancestry (2.74%) and the lowest was in Ashkenazi Jewish (0.56%) or African (0.50%) ancestries (Table 1). The two well-studied European founder mutations accounted for >80% of *MUTYH* PVs among individuals who reported Native American, European, or Latin American/Caribbean ancestry, but were nearly absent from individuals of Asian ancestry (Table 1). Among those ascertained for testing for suspicion of hereditary CRC, the prevalence of monoallelic *MUTYH* PVs was 2.15%. We also identified additional potential founder mutations in the European, Asian, African and Latin American/Caribbean populations.

Table 1. Prevalence of monoallelic *MUTYH* PVs among individuals who reported a single ancestry

Ancestry	Prevalence	Proportion of PVs that are Founder Mutations
Asian	2.74%	0.9%
European	1.99%	87.5%
Native American	1.72%	92.0%
Latin American/Caribbean	1.41%	80.6%
Near/Middle Eastern	1.16%	30.8%
Ashkenazi Jewish	0.56%	68.2%
African	0.50%	62.6%

Conclusions: This is the largest study to date of the prevalence of monoallelic PVs in *MUTYH* among different ancestries undergoing multi-gene panel testing for inherited cancer risk. Since approximately 90% of the individuals tested were ascertained for suspicion of HBOC rather than hereditary CRC, the 1.82% prevalence may be a reasonable approximation of the carrier frequency in the general population. These findings have important implications for genetic counseling about recurrence risk and the implementation of new National Comprehensive Cancer Network guidelines for earlier and more frequent colonoscopies than what is recommended for average risk individuals.

OC53 - METACHRONOUS CANCERS FOLLOWING SEGMENTAL OR EXTENDED COLECTOMY IN LYNCH SYNDROME: A SYSTEMATIC REVIEW & META-ANALYSIS

K. J. Monahan¹, S. S. Malik², M. Lythgoe¹

¹Family History of Bowel Cancer Clinic, West Middlesex University Hospital London, ²Imperial College London London

Introduction: Around 5% of colorectal cancers are due to mutations within DNA mismatch repair genes, resulting in Lynch Syndrome (LS). These mutations have a high penetrance (85-90%), with early onset of colorectal cancer at a mean age of 45 years. The mainstay of surgical management is either a segmental or extensive colectomy. Currently there is no unified agreement as to which management strategy is superior due to limited conclusive empirical evidence available.

Aim: A systematic review and meta- analysis to evaluate the risk of metachronous colorectal cancer (MCC) and mortality in LS following segmental and extensive colectomy.

Methods: A systematic review of the Pubmed database was conducted. Studies were included/ excluded based on pre-specified criteria. To assess the risk of MCC and mortality attributed to segmental or extensive colectomies, relative risks (RR) were calculated and corresponding 95% confidence intervals (CI). Publication bias was investigated using funnel plots. Statistical analysis was conducted using the R program (version 3.2.3).

Results: The literature search identified eighty-five studies. After further analysis nine studies were eligible for inclusion in this study. Pooled data identified 1389 patients followed up for a mean of 100.7 months with a mean age of onset of 45.5 years of age. 1119 patients underwent segmental colectomies with risk of MCC in this group of 28.2% at the end of follow-up. 270 patients had extensive colectomies with a MCC risk of 4.7% (0% in those with a panproctocolectomy). A segmental colectomy was significantly associated with an increased risk of MCC (RR=5.12; 95% CI: 2.88- 9.11; Figure 1), but no significant association with mortality was identified (RR=1.65; 95% CI: 0.90-3.02).

Conclusion: In LS, segmental colectomy results in a significant increased risk of developing MCC. Despite the choice of segmental or extensive colectomies having no statistically significant impact on mortality, the choice of initial surgical management can impact a patient's requirement for further surgery. An extensive colectomy can result in decreased need for further surgery; reduced hospital stays and reduced costs. The significant difference in the risk of MCC, following segmental or extensive colectomies should be discussed with patients when deciding appropriate management.

OC56 - FIVE-YEARLY COLONOSCOPY SURVEILLANCE IN AT-RISK RELATIVES OF PATIENTS WITH FAMILIAL COLORECTAL CANCER TYPE X MAY LEAD TO DELAYED DETECTION OF ADVANCED ADENOMAS

M. Ow¹, J. Arnold², R. Bergman³, T. Chalmers-Watson⁴, B. Griffiths⁵, J. Keating⁶, C. Wakeman⁷, S. Parry⁸

¹New Zealand Familial Gastrointestinal Cancer Service. Department of Gastroenterology and Hepatology, Auckland District Health Board. Department of Medicine, University of Auckland. Auckland, New Zealand, ²New Zealand Familial Gastrointestinal Cancer Service. Auckland District Health Board. Auckland, New Zealand, ³New Zealand Familial Gastrointestinal Cancer Service. Department of Gastroenterology and Hepatology, Auckland District Health Board. Auckland, New Zealand, ⁴New Zealand Familial Gastrointestinal Cancer Service. Department of Gastroenterology, Canterbury District Health Board. Department of Medicine, University of Otago. Christchurch, New Zealand, ⁵New Zealand Familial Gastrointestinal Cancer Service. Department of Gastroenterology, Capital and Coast District Health Board. Wellington, New Zealand, ⁶New Zealand Familial Gastrointestinal Cancer Service. Wellington, New Zealand, ⁷New Zealand Familial Gastrointestinal Cancer Service. Department of Surgery, Canterbury District Health Board. Department of Surgery, University of Otago. Christchurch, New Zealand, ⁸New Zealand Familial Gastrointestinal Cancer Service. Auckland District Health Board. Department of Medicine, University of Auckland. Auckland, New Zealand

Background: Familial colorectal cancer type X (FCRCTX), defined as Amsterdam criteria-positive families without evidence of mismatch repair gene involvement, is reported to have a lower CRC risk than Lynch Syndrome.¹ Consequently, a less stringent surveillance protocol of 3- to 5-yearly colonoscopy is considered appropriate. Within the New Zealand Familial Gastrointestinal Cancer Service, at-risk first-degree relatives (FDRs) in FCRCTX families are recommended to initially have 3-yearly colonoscopy.

Objective: Evaluate the yield of advanced colorectal neoplasia at surveillance colonoscopy in at-risk FDRs of FCRCTX families to determine if surveillance interval could be safely extended to 5-yearly.

Methods: A retrospective review of findings at surveillance colonoscopy, for a minimum of 5 years (yrs) to age 75, was conducted for at-risk FDRs of family members with CRC. FDRs with CRC pre-enrolment were excluded. Advanced colorectal neoplasia was defined as high-risk adenomas (>10mm; villous; or high-grade) or CRC.

Results: One hundred and thirty at-risk FDRs from 47 FCRCTX families underwent surveillance colonoscopy over a median duration of 10.1 yrs. Median age at start of surveillance was 46.3 yrs. A total of 571 surveillance colonoscopies were performed with a median interval of 2.9 yrs between procedures. Of the 130 FDRs, 25 (19.2%) had at least 1 advanced neoplasm. Forty-one high-risk adenomas were removed in 24 (18.5%) individuals – 24 in 19 (14.6%) individuals at index procedure, 17 in 11 (8.5%) individuals at subsequent procedures. CRC occurred in 2 (1.5%) individuals – 5.1 yrs and 8.6 yrs from last procedure. If surveillance interval, following a normal colonoscopy or low-risk (1-2 diminutive) polyps, was extended from 3- to 5-yearly, 7/17 (41.2%) high-risk adenomas in 6 (4.6%) individuals would have had delayed detection. No delay in CRC detection would have occurred. No advanced neoplasia occurred in FDRs with 3 consecutive normal procedures.

Conclusion: In FCRCTX, advanced colorectal neoplasia was detected in a fifth of at-risk FDRs, with just over half identified at index procedure. Few CRCs occurred. Extending surveillance from 3- to 5-yearly would have led to delayed detection of 41.2% of non-index high-risk adenomas. We propose a tailored approach to surveillance for at-risk FDRs based on polyp history, reserving 5-yearly intervals for FDRs who have had 3 normal procedures.

1. Lindor NM, Rabe K, Petersen GM, et al. Lower cancer incidence in Amsterdam-I criteria families without mismatch repair deficiency: familial colorectal cancer type X. *JAMA* 2005; 293:1979–85

OC58 - VITAMIN D AND CALCIUM INTAKE IN RELATION TO COLORECTAL TUMOR RISK IN PERSONS WITH LYNCH SYNDROME

F. van Duijnhoven¹, Z. Wang², H. Vasen³, F. Nagengast⁴, J. Kleibeuker⁵, E. Kampman¹

¹Division of Human Nutrition, Wageningen University & Research Wageningen, the Netherlands, ²Human Genetics Center, School of Public Health, University of Texas Health Science Center at Houston Houston, TX, USA, ³Foundation for the Detection of Hereditary Tumors (StOET) Leiden, the Netherlands, ⁴Department of Gastroenterology, Radboud University Medical Center Nijmegen, the Netherlands, ⁵Department of Gastroenterology and Hepatology, University of Groningen, University Medical Center Groningen Groningen, the Netherlands

Background

Although vitamin D and calcium influence sporadic colorectal carcinogenesis, the role in the development of hereditary colorectal cancer is unknown. We investigated the association of dietary vitamin D and calcium intake, alone and in combination, with colorectal tumors in persons with Lynch syndrome (LS).

Materials and methods

In the Geolynch prospective cohort study, 466 persons with LS completed a food frequency questionnaire and a lifestyle questionnaire between 2006 and 2008 and were followed up for colorectal tumors until 2014. Vitamin D and calcium intake were calculated using the Dutch food composition table. Information about performed colonoscopies, colon surgeries, carcinoma and adenoma occurrences was collected by reviewing medical records.

Cox proportional hazard models were used to estimate adjusted hazard ratios (HRs) and 95% confidence intervals (CI). Using robust sandwich variance estimates to control for dependency within families, models were adjusted for age, gender, education level, total energy intake, smoking status, physical activity level, and stratified by number of colonoscopies during follow-up.

Results

During a median follow-up of 59 months, 198 persons with LS developed a colorectal tumor. A high vitamin D intake compared with a low vitamin D intake (≥ 3.8 ug/day versus < 3.8 ug/day) showed a HR (95% CI) of 0.73 (0.51-1.05), while a high calcium intake compared with a low calcium intake (≥ 956 mg/day versus < 956 mg/day) resulted in a HR (95% CI) of 0.80 (0.61-1.06). Persons with both a high vitamin D as well as a high calcium intake were associated with a lower colorectal tumor risk (HR (95% CI) = 0.63 (0.41–0.95)) compared with those with a low vitamin D as well as a low calcium intake.

Conclusion

The results of this prospective study indicate that a combined high intake of dietary vitamin D and calcium is associated with a lower colorectal tumor risk in persons with LS.

OC59 - QUALITATIVE INTERVIEWS TO BETTER UNDERSTAND BARRIERS TO COMMUNICATION AND THE INFORMATION NEEDS OF PATIENTS WITH LYNCH SYNDROME.

S. Goodman¹, H. Skirton¹, R. Jones¹

¹*Plymouth University Plymouth, UK*

Background: Biological relatives of people with Lynch syndrome (LS) may have a high lifetime risk of bowel and other cancers. Consequently it is important that those diagnosed with LS share information about the implications of their diagnosis with relatives. Evidence suggests that only a minority of at risk relatives access screening colonoscopy or genetic testing and this is sometimes due to lack of understanding about their personal risk.

Aim: In the Family Web study we aim to improve the dissemination of information within these families via a website where relatives can share personal information securely online. To inform web site development we have carried out an interview study to better understand barriers to communication and the information needs of patients with LS.

Methods: We recruited patients via charity websites, genetics clinics and colorectal clinics in the UK to a cross-sectional survey at the end of which participants were invited to volunteer for a semi-structured telephone interview. So far a purposive sample of 11 volunteers with LS has been interviewed. Recorded interviews were transcribed and analysed using thematic analysis.

Results: Key themes included inadequate information and support, with emphasis on a desire for better understanding by health professionals outside genetics. Participants also discussed the impact of the diagnosis, especially in context of unsettled family relationships. Issues where more information was desirable were: advice on cancer risk reducing behaviour particularly dietary change and targeted surveillance and more ‘gene specific’ information.

While little criticism was expressed towards genetics services, participants voiced their feelings of isolation and self-reliance with little ongoing support from health professionals. They suggested that information on a variety of topics was required but advice on risk reduction through a healthy lifestyle was most consistently cited.

Conclusions: These findings are congruent with a recent UK survey of LS patients which recommends “high quality and tailored information” should be available on a variety of platforms to help them explain the implications of their diagnosis to their relatives. Therefore the content to the website will be written to answer the questions of users. In addition, material for health professionals will be provided and advice for relatives about how to access health services. These data appear to validate our approach to this issue.

OC65 - DO LYNCH SYNDROME PATIENTS BENEFIT FROM SHORTER COLONOSCOPY INTERVALS? A POOLED ANALYSIS OF SURVEILLANCE STUDIES FROM GERMANY, THE NETHERLANDS, AND FINLAND

C. Engel^{*1}, T. Seppälä^{*2}, H. Vasen^{*3}, S. Aretz⁴, R. Häneburg⁵, S. Holzapfel¹, E. Holinski-Feder⁶, V. Steinke-Lange⁶, M. Morak⁶, M. von Knebel Doeberitz⁷, M. Kloor⁷, N. Rahner⁸, G. Mäkitie⁹, H. K. Schackert¹⁰, W. Schmiegell¹¹, K. Schulmann¹², R. Böttner¹³, W. de Vos tot Nederveen Cappel¹⁴, K. Bucksch¹, K. Pylvanainen¹⁵, J. P. Mecklin¹⁶, M. Loeffler¹

¹Institute for Medical Informatics, Statistics and Epidemiology, University of Leipzig (Leipzig, Germany), ²Department of Abdominal Surgery, Helsinki University Hospital (Helsinki, Finland), ³Department of Gastroenterology and Hepatology, Leiden University Medical Centre (Leiden, The Netherlands), ⁴Institute of Human Genetics, University of Bonn; Center for Hereditary Tumor Syndromes, University of Bonn (Bonn, Germany), ⁵Department of Internal Medicine I, University Hospital Bonn; Center for Hereditary Tumor Syndromes, University Hospital Bonn; Institute of Human Genetics, University of Bonn (Bonn, Germany), ⁶Medizinische Klinik und Poliklinik IV, Campus Innenstadt, Klinikum der Universität München; MGZ, Center of Medical Genetics (Munich, Germany), ⁷Department of Applied Tumour Biology, Institute of Pathology, University Hospital Heidelberg; Cooperation Unit Applied Tumour Biology, German Cancer Research Center (DKFZ) (Heidelberg, Germany), ⁸Institute of Human Genetics, Medical School, Heinrich Heine University (Düsseldorf, Germany), ⁹Center for Hereditary Tumors, HELIOS Klinikum Wuppertal, University Witten-Herdecke (Wuppertal, Germany), ¹⁰Department of Surgical Research, Technische Universität Dresden (Dresden, Germany), ¹¹Department of Medicine, Knappschaftskrankenhaus, Ruhr-University Bochum (Bochum, Germany), ¹²Department of Internal Medicine, Hematology and Oncology, Klinikum Arnsberg (Arnsberg, Germany), ¹³Institute of Pathology, University of Cologne (Cologne, Germany), ¹⁴Department of Gastroenterology and Hepatology, Isala Clinics (Zwolle, The Netherlands), ¹⁵Department of Education and Research, Jyväskylä Central Hospital (Jyväskylä, Finland), ¹⁶Department of Surgery, Jyväskylä Central Hospital and University of Eastern Finland (Jyväskylä, Finland)

on behalf of the German HNPCC Consortium, the Dutch Lynch Syndrome Collaborative Group, and the Finnish Lynch Syndrome Registry.

(* contributed equally)

Background and objective: Although regular colonoscopy is the method of choice for early detection of adenoma and CRC in Lynch Syndrome (LS) patients, there is no international consensus as to the optimal duration of examination intervals. A Finnish controlled trial has shown that 3-year intervals lead to a decrease of CRC risk and overall mortality in HNPCC families. In Germany, annual colonoscopies are effective to detect early CRC stages. However, no comparative studies have investigated the impact of different interval durations on CRC incidence or tumour stages. We have therefore conducted a pooled analysis of prospective colonoscopic surveillance data from LS registries in Germany (G), the Netherlands (N), and Finland (F), each recommending different intervals ranging from 1 to 3 years. We sought to determine whether shorter intervals are associated with a lower CRC incidence, lower adenoma detection rate, and more favourable tumour stages. Here we report first results of this study.

Patients and Methods: All patients were carriers of pathogenic germline mutations in *MLH1*, *MSH2*, or *MSH6*. Prospective observation started (ended) at the first (last) colonoscopy after registration. Patients were either CRC-free at start of observation, or had already CRC before. Colonoscopies were conducted according to national standards. Multivariate linear, logistic, and Cox regression analyses were used to investigate associations.

Results: The pooled data set comprised 3051 LS patients (MLH1: 1543, MSH2: 1103, MSH6: 405) from G (1175), N (855), and F (1021), with a total of 18617 colonoscopies, and a median age at first colonoscopy of 45 (G), 43 (N), 41 (F) years. The median colonoscopy interval per patient was 1.1 (G), 2.0 (N), and 2.4 (F) years, reflecting the different surveillance recommendations. 1152 patients (38%) already had CRC before start of observation. Cumulative CRC incidence (9-13% for first CRC at 10y follow-up), adenoma detection rates, and CRC stages were not significantly different between countries. There was no significant association between CRC stages and time since last colonoscopy for intervals up to 3.5y, with a trend to unfavourable stages for intervals ≥ 3.5 y. Adenoma detection rate increased significantly with longer intervals in multivariate analysis.

Conclusion: The first results of this large international analysis did not reveal beneficial effects of shorter colonoscopy intervals on CRC incidence and tumour stage distribution.

OC71 - TOWARDS THE VALIDATION OF DIAGMMR AS THE FUNCTIONAL LYNCH SYNDROME CARRIER TEST

M. Kansikas¹, J. Kantelinen¹, M. Kasela², P. Paloviita¹, L. Vähätalo¹, A. Moilanen¹, E. Kärkkäinen¹, P. Peltomäki³, K. Pylvänäinen⁴, L. Renkonen-Sinisalo⁵, A. Lepistö⁵, J. Mecklin⁶, M. Nyström⁷

¹LS CancerDiag Ltd. Helsinki, Finland, ²LS CancerDiag Ltd. and Department of Biosciences, University of Helsinki, Helsinki, Finland,

³Department of Medical and Clinical Genetics, University of Helsinki, Helsinki, Finland, ⁴Department of Education and Science,

Central Finland Health Care District, Finland, ⁵Department of Surgery, Abdominal Center, Helsinki University Hospital, Helsinki,

Finland, ⁶Department of Education and Science, Central Finland Health Care District and University of Eastern Finland, Finland,

⁷Department of Biosciences, University of Helsinki, Helsinki, Finland

Individuals predisposed to Lynch syndrome (LS, also known as Hereditary non-polyposis colorectal cancer) inherit a loss of function mutation in one allele of a mismatch repair (MMR) gene.

Functional assessment of the MMR proteins has been used to characterize the functional effects of different mutations and it has been shown to be able to detect reduced MMR function in correlation to reduced MMR mRNA expression levels.

The functional DiagMMR method recognizes reduced MMR by quantitatively assessing the MMR efficiency of cells derived from normal skin and hence allows inherited cancer predisposition to be diagnosed from healthy LS mutation carriers without mutation sequencing. Our aim is to complete a clinical validation of the method by first determining gene specific assay cut-offs using samples representing a broad range of pathogenic *MLH1*, *MSH2* and *MSH6* mutations, followed by the assessment of assay sensitivity and specificity.

Altogether, over 150 skin samples have been collected from LS mutation carriers and their unaffected family members in Finland for the optimization and validation of the assay. With these, the DiagMMR method has been optimized for the determination of gene specific cut-offs for distinguishing *MLH1*, *MSH2* and *MSH6* mutation carriers from non-affected individuals. So far, the majority of the mutation positive samples collected are from *MLH1* mutation carriers (n=100, of which 58 are from carriers of the Finnish founder mutation affecting exon 16), while samples from *MSH2* (n=22) and *MSH6* (n=9) remain more rare.

Our preliminary results suggest that DiagMMR assessment of skin samples can be used to recognize individuals with an inherited loss of function mutation in an MMR gene and thereafter a decreased MMR capacity (i.e., Lynch syndrome) in normal cells. In order to determine the assay cut-offs, more samples representing a wider spectrum of pathogenic mutations in *MLH1*, *MSH2* and *MSH6* need to be tested.

OC73 - A MURINE MODEL FOR PROOF OF CONCEPT OF A VACCINE AGAINST LYNCH SYNDROME-ASSOCIATED CANCERS

M. Kloor¹, M. Oezcan¹, A. Ahadova¹, Y. Yuan², P. Bork², S. Sei³, R. Shoemaker³, O. Gelincik⁴, S. Lipkin⁴, J. Gebert¹, M. von Knebel Doeberitz¹

¹Department of Applied Tumor Biology, Institute of Pathology, University Hospital Heidelberg Heidelberg, ²EMBL Heidelberg Heidelberg, ³Department of Cancer Prevention, NCI Bethesda, ⁴Weill Cornell Medical College New York

Background:

Microsatellite-unstable (MSI) cancers occurring in the context of Lynch syndrome elicit pronounced tumor-specific immune responses. These immune responses are specifically directed against frameshift peptide (FSP) antigens, which result from mismatch repair (MMR) deficiency-induced insertion/deletion mutations in coding microsatellites (cMS). We have recently completed a phase I/IIa vaccination trial that successfully demonstrated safety and immunogenicity of FSP antigens in MSI colorectal cancer patients. Previously, we also reported the detection of cMS frameshift mutations in MMR-deficient mouse intestinal tumors. To further develop a cancer-preventive vaccine in Lynch syndrome, we aimed to establish a preclinical mouse model.

Materials and Methods:

In order to identify potential mutational targets and derived FSP antigens in MMR-deficient mouse tumors, a systematic database search was performed to identify cMS based on murine genome sequences. Subsequently, intestinal cancers of Lynch syndrome mice (*Msh2*^{fllox/fllox}*VpC*^{+/+}) were evaluated for mutations affecting the most promising candidate microsatellites. FSP neoantigens were predicted and synthesized for the most frequently mutated cMS. Immunogenicity of ten FSP neoantigens was evaluated after vaccination of C57BL/6 mice using IFN-gamma ELISpot to measure CD4/CD8 T cell responses and peptide ELISA to measure humoral immune responses.

Results:

Coding microsatellite mutation profiling of murine Lynch syndrome colorectal cancers revealed 13 candidate cMS showing a mutation frequency of 15% or higher. The cMS most frequently affected by frameshift mutations was located in the *Nacad* gene (75% of tested tumors). Four FSP neoantigens derived from cMS mutations in the genes *Nacad*, *Maz*, *Xirp1*, and *Senp6* elicited strong antigen-specific cellular and humoral immune responses when administered as a vaccine to C57BL/6 mice. Based on the cMS mutation data, a vaccine with these four FSP neoantigens is predicted to cover about 75% of cancers in Lynch mice.

Conclusion:

We have identified 4 immunogenic FSP neoantigens derived from commonly mutated cMS in murine Lynch syndrome colorectal cancers. These results provide the basis for evaluating the concept of cancer-preventive FSP vaccines in a mouse model of Lynch syndrome. This spontaneous tumor model allows longitudinal monitoring of immune responses and tumor development in different vaccination schemes, adjuvants and combination with chemoprevention.

OC75 - TAILORED SURGICAL TREATMENT OF DUODENAL POLYPOSIS IN FAMILIAL ADENOMATOUS POLYPOSIS SYNDROME.

T. Augustin¹, M. Moslim¹, R. M. Walsh¹, A. Tang¹

¹*General Surgery Cleveland*

Aim: To describe the Cleveland Clinic experience in patients undergoing surgery for duodenal polyposis associated with Familial Adenomatous Polyposis (DPFAP) with an emphasis on selection of operative approach.

Methods: Data on patients undergoing surgery for DPFAP were retrospectively collected. Patients with duodenal cancer were excluded.

Results: 54 patients DPFAP underwent surgery from 1997 to 2016. Forty patients (77%) underwent pancreas sparing duodenectomy (PSD) (group 1), 9 (17.3%) Whipple (group 2) and 3 (6%) segmental resection not including resection of the ampulla (group 3; SR). Gender distribution, age and BMI were statistically comparable between the groups. Asymptomatic presentation was noted in 75% of PSD, 100% of Whipple and 44% of SR patients (p value 0.09). Spigelman staging was significantly different between the groups with PSD and SR patients having a higher percentage of Stage III and IV patients compared to Whipple (p 0.012). Interval from first scope to surgery was comparable across groups (4.5 vs. 4.8 vs. 4.3 years).

There was no statistically significant difference between the groups with regard to pancreatic fistula, biliary fistula, delayed gastric emptying or anastomotic leak. There were no 30-day mortalities. Mean length of stay was shortest in the SR group (14.3 PSD group, 12.9 Whipple and 8.7 days SR group, p 0.01). Final pathology revealed no statistically significant difference in percent with high-grade dysplasia (HGD) between groups (37% vs. 71 % vs. 0%, p 0.08).

Long term follow-up (FU) greater than 18 months and was available for 88% of patients. There was only one patient noted to have progression of disease in duodenum or jejunum requiring additional resection. However disease progression to HGD in stomach was noted in 1(3%) of PSD, 2(29%) of Whipple and 1(33%) of SR patients (p 0.03). There were 2 patients with disease progression to gastric cancer in the PSD group (6%) and 1 patient in the Whipple group (14%) with none in the SR group (p 0.68). Overall survival was comparable across groups (p 0.09).

Conclusion: While majority of patients with DPFAP undergo PSD for Spigelman IV disease; whipple, ampullectomy and SR are also selectively appropriate based on anatomy, concern of malignancy, and location of dominant polyp location. Disease progression after surgery is most noted in stomach and should be the focus of surveillance. In appropriately selected patients survival is not dependent on type of surgery.

OC76 - THE RELEVANCE OF FAMILY HISTORY TO INCREASED RISK OF COLORECTAL CANCER IN KOREA

D. Kim¹, W. Kim², S. Won², S. Kang¹, H. Oh¹, I. T. Son¹, S. I. Kang¹, K. J. Park³, S. Jeong³, S. Ryoo³, J. W. Park³

¹Surgery Seong-nam, ²Interdisciplinary Program of Bioinformatics Seoul, ³Surgery Seoul

~Background: A family history of colorectal cancer (CRC) has been regarded as a risk factor based on results from Western population-based studies. We aim to estimate the heritability of CRC and develop the risk prediction model relative risk (RR) associated with family history of CRC in the Korea population.

Materials and Methods: We used a prospective cohort of CRC patients-based pedigree including 1,036 families with 19,392 individuals. To estimate the heritability of CRC, we developed a linear mixed model which can estimate the variance components directly on the liability scale of the binary trait. And then, conditional probabilities of being affected given a family history were calculated using the liability threshold model. To adjust the ascertainment bias, we assumed that the prevalence CRC is 0.00239 in Korea based on the National Cancer Center database.

Results: Using estimates of variance components, the heritability underlying Korea population was estimated at 0.0539. The risk probability (RP) of the individual with no family history of CRC was 0.00232 which is slightly smaller than global prevalence. However, individuals with 1 first degree relative (FDR) with CRC (RP=0.003; RR= 1.29) or 2 FDRs with CRC (RP= 0.00386; RR=1.66) were at increased risk for developing CRC. In the same vein, individuals with 3 FDRs with CRC showed similar results such that RPs were 0.00482 and RRs were 2.08.

Conclusion: Individuals with a family history of CRC appear to have a significantly elevated risk of incidental sporadic CRC. Our result might be useful in guidelines and clinical practice for subjects with a family history of CRC in Korea.

OC79 - A NOVEL APC PROMOTER 1B DELETION SHOWS A FOUNDER EFFECT IN ITALIAN PATIENTS WITH FAMILIAL ADENOMATOUS POLYPOSIS

G. N. Ranzani¹, M. Marabelli¹, V. Gismondi², M. T. Ricci³, A. Vetro⁴, R. Abou Khouzam¹, V. Rea², M. Vitellaro³, O. Zuffardi⁴, L. Varesco²

¹Department of Biology and Biotechnology, University of Pavia, Pavia, Italy, ²Unit of Hereditary Cancer, IRCCS AOU San Martino-IST, Genoa, Italy, ³Hereditary Digestive Tract Tumours Unit, Department of Preventive and Predictive Medicine, IRCCS Istituto Nazionale dei Tumori Foundation, Milan, Italy, ⁴Department of Molecular Medicine, University of Pavia, Pavia, Italy

To date, over 1,500 different *APC* pathogenic mutations have been identified in *APC*-associated polyposis (AAP) patients, with the great majority being nonsense or small deletions/insertions that lead to a truncated protein product. In addition to point mutations, large allelic deletions, abnormal ratio of mRNA isoforms, reduced or absent expression from one allele and deep intronic sequence changes have also been reported. A small fraction of families has been associated with germline defects involving the *APC* promoter region. *APC* is regulated by 1A and 1B promoters and transcribed into multiple mRNA isoforms, with transcription products being regulated by either of the two promoters in a tissue-specific manner. The major transcript is initiated by 1A, while 1B produces three different transcripts, 1B1, 1B2 and 1B3. Promoter 1B is the most distal one and is 586 bp in length, while 1A is located approximately 30 kb downstream and is 866 bp long. We identified a deletion encompassing *APC* 1B promoter in a proband from a large colonic polyposis family (F1); this family was traced back six generations to a couple married in 1797 and polyposis was reported in three of six branches descending from the founding couple. We precisely mapped the deletion (6,858 bp in length) by combining Multiplex Ligation-dependent Probe Amplification (MLPA), array-CGH, long-range PCR and DNA sequencing. Moreover, by Single Nucleotide Primer Extension (SNUPE) on RNA from the blood of the deletion carrier, we could demonstrate *APC* monoallelic expression. Following the design of “diagnostic” primers, we extended the genetic test to the proband’s family members (F1), as well as to members of two additional polyposis families (F2 and F3) originating from the same geographic area (Tuscany). DNA was available for 16 individuals: 9 from F1 (5 affected and 4 unaffected), 6 from F2 (3 affected and 3 unaffected) and 1 from F3 (affected). The same *APC* 1B promoter deletion was identified in all 9 affected individuals and was excluded in all 7 subjects without polyposis. F2 was traced to the same small town of origin of F1, but the proband’s grandmother affected by colorectal cancer was adopted and the surnames of her biological parents were unknown. F3 was traced to an area close to the small town of origin of F1, and the same surname of F1 was reported in the F3 proband’s grandfather affected by polyposis. Taken together, these observations point to a founder effect of the above *APC* promoter 1B deletion in Italy.

OC80 - CHROMOCOLONOSCOPY WITH INDIGO CARMINE FACILITATES HIGH ADENOMA DETECTION COMPARED WITH STANDARD ENDOSCOPY IN LYNCH SYNDROME IN AN EXPERT SETTING

R. HÄ¼neburg¹, P. van Heteren¹, S. Holzapfel², C. Engel³, M. LÄ¼ffler³, N. Rahner⁴, G. MÄ¼slein⁵, W. Schmiegel⁶, S. Aretz², C. P. Strassburg¹, J. Nattermann¹

¹Department of Internal Medicine I, Center for Hereditary Tumor Syndromes, University Hospital Bonn Bonn, Germany, ²Institute of Human Genetics, Center for Hereditary Tumor Syndromes, University Hospital Bonn Bonn, Germany, ³Institute for Medical Informatics, Statistics and Epidemiology, University of Leipzig Leipzig, Germany, ⁴Institute of Human Genetics, Medical School, Heinrich Heine University Duesseldorf, Germany, ⁵Center for Hereditary Tumors, HELIOS Klinikum Wuppertal, University Witten-Herdecke Wuppertal, Germany, ⁶Department of Medicine, Knappschaftskrankenhaus, Ruhr-University Bochum Bochum, Germany

Introduction: As currently described by Møller et al., colorectal cancer arises in Lynch syndrome (LS) patients despite regular colonoscopic surveillance. In general the adenoma-carcinoma sequence is accepted for LS-related colorectal cancer (CRC). The adenoma detection rate (ADR) per colonoscopy is approximately 10% by using standard endoscopic techniques. Several clinical trials have described an enhanced ADR of up to 28% when chromocolonoscopy was performed.

Furthermore adenomas have been described with a non-polypoid shape, making it difficult to detect during colonoscopy. Aim of the current study was to compare the ADR in LS expert centers Patients and Methods: Patients with LS and proven germline mutation in a mismatch repair gene living in the Rhein-Ruhr-region (Germany) participated in the intensified colonoscopy surveillance program of the German HNPCC consortium. Patients were asked to undergo their yearly surveillance colonoscopy in three different expert centers (centers A, B, C) or local resident gastroenterologists (D). During all examinations a pathologist attended the colonoscopy and collected the specimens. The pathological analysis was performed in the reference pathology of the German HNPCC consortium. A central review of the endoscopy protocols was performed.

Results: A total of 110 patients (61 male/49 female) with a median age of 50 years (+/- 12) were enrolled into this study. All patients had a proven mutation (41 MLH1, 54 MSH2, 14 MSH6, 2 PMS2), 68 (62%) had undergone previous surgery due to CRC. Center A (31 patients), B (21) and D (26) performed standard colonoscopy. Center C (32) used 0.4% indigo carmine for pan-colonic chromocolonoscopy. Besides age, patient demographics were similar. A total number of 51 adenomas and 50 hyperplastic polyps were detected.

Total ADR was 30/110 (27%), and differed between the study centers: A (7/31, 22.6%), B (4/21, 19%), C (13/32, 41%), and D (6/26, 23.1%). Differences between the centers were not significant, but there was a clear trend in favor of chromocolonoscopy (A+B+D vs C; p=0.059). The rate of hyperplastic polyps was for A (7/31, 22.6%), B (2/21, 9.5%), C (12/32, 36%) and D (7/26, 27%). One colorectal cancer was detected in the descending colon (Center D).

Conclusion: In our multi-center study, the ADR was markedly higher than described before in Germany. Of note, ADR was even higher when chromocolonoscopy was performed, suggesting that chromocolonoscopy should be routinely performed in this high risk population.

The high number of hyperplastic polyps is surprising and needs further investigation.

OC82 - CANCER RISKS IN FAMILY MEMBERS OF CMMRD PATIENTS – THE FINAL RESULTS

M. Suerink¹, M. Rodr guez-Girondo², S. ten Broeke¹, S. Andrew³, G. Capell n Munar⁴, G. Evans⁵, M. Farrell⁶, M. Genuardi⁷, Y. Goldberg⁸, E. Gomez Garcia⁹, K. Guthrie¹⁰, K. Heinimann¹¹, J. Hoell¹², S. Holzapfel¹³, K. Jasperson¹⁴, M. Jongmans¹⁵, I. Kedar¹⁶, N. Lavoine¹⁷, T. van Os¹⁸, T. Ripperger¹⁹, L. Senter²⁰, W. Sjr sen²¹, L. Sunde²², C. Therkildsen²³, M. G. Tibiletti²⁴, A. Trainer²⁵, Y. Vos²⁶, A. Wagner²⁷, I. Winship²⁸, S. Zimmermann²⁹, H. Vasen³⁰, J. Houwing-Duistermaat², M. Nielsen¹

¹Clinical Genetics Leiden, ²Medical Statistics and Bioinformatics Leiden, ³Medical Genetics Edmonton, ⁴Laboratori de Recerca Translacional Barcelona, ⁵Division of Evolution and Genomic Medicine Manchester, ⁶Mater Private Hospital Dublin, ⁷Istituto di Medicina Genomica Rome, ⁸Sharett Institute of Oncology Jerusalem, ⁹Clinical Genetics Maastricht, ¹⁰Center for Individualized Medicine Jacksonville, ¹¹Research Group Human Genomics Basel, ¹²Pediatric Oncology Dusseldorf, ¹³Center for Hereditary Tumor Syndromes Bonn, ¹⁴Huntsman Cancer Institute Salt Lake City, ¹⁵Human Genetics Nijmegen, ¹⁶The Raphael Recanati Genetics Institute Petah Tikva, ¹⁷Children and Adolescents Oncology Villejuif, ¹⁸Clinical Genetics Amsterdam, ¹⁹Human Genetics Hannover, ²⁰Human Genetics Columbus, ²¹Medical Genetics Trondheim, ²²Clinical Genetics Skejby, ²³HNPCC Register Hvidovre, ²⁴Pathology Ospedale di Circolo Varese, ²⁵Familial Cancer Centre Melbourne, ²⁶Genetics Groningen, ²⁷Clinical Genetics Rotterdam, ²⁸Medicine Melbourne, ²⁹Pediatric Hematology and Oncology Frankfurt, ³⁰Gastroenterology and Hepatology Leiden

Purpose Biallelic mutations in the mismatch repair (MMR) genes cause a recessive form of childhood cancer predisposition known as constitutional mismatch repair deficiency (CMMRD). Family members with heterozygous mutations have Lynch syndrome (LS). Their cancer risks are expected to be different from previously reported risks in LS families that were ascertained on clinical characteristics. Recent publications, based on complex statistical methods to correct for the ascertainment bias, indicate that unbiased cancer risks in LS families are indeed lower, particularly in PMS2 mutation carriers. With a novel statistical approach, using data on family members of CMMRD patients, we aimed to establish unbiased cancer risk estimates.

Methods Information on family members of 53 PMS2 families, where the index was a patient with CMMRD, was collected from literature and through collaboration. They represent unbiased families since they were ascertained because of the CMMRD phenotype of the index and not because of family history of cancer. Family members were included in the analysis if gender and age at event, last contact or death were known. CMMRD patients were excluded. This meant that 491 family members from 37 families could be included in the analysis. Cox regression on the cause-specific hazards was used to estimate the effect of carrier status on colorectal cancer (CRC) risk correcting for the presence of competing risks. Missing data with regard to carrier status was dealt with using kinship weights. Confidence intervals (CI) were obtained by bootstrapping at family level.

Results Among the 491 family members that were included in the analysis, there were 21 CRC cases. Average age at cancer development was 59 (Range 41 - 77). Cumulative CRC risk at age 70 was 10.4% (95%CI 4.6-16.5%) in men and 6.4% (95%CI 1.7%-12%) in women. There were only three cases of endometrial cancer, indicating that these risks are also lower than previously reported.

Conclusion Our results are in line with previous reports on cancer risks in LS that used statistical methods to correct for ascertainment bias and they confirm lower cancer risks in these families. With the increasing implementation of immunohistochemistry for the MMR-proteins in unselected cancer patients, more mildly affected families are expected to come to light in the near future. The results of our study implicate that surveillance protocols might not have to be as stringent for these families.

OC85 - PJS SMALL BOWEL MANAGEMENT – AN AUDIT OF THE LAST 9 YEARS EXPERIENCE

N. Hodges¹, A. Humphries¹, S. Clark¹, A. Latchford¹

¹St Mark's Hospital Harrow, London

Introduction:

A major clinical problem in Peutz-Jeghers syndrome (PJS) is management of small bowel (SB) polyps. Surveillance is recommended to identify and resect significant polyps (>1.5-2cm) to prevent complications including obstruction due to intussusception. The aim of this study was to review outcomes of SB surveillance and intervention in patients with PJS.

Methods:

Patients who had SB surveillance under our care between January 2007 and July 2016 were included. Registry and hospital electronic notes were reviewed. A SB polyp was defined as a polyp at or distal to the duodenojejunal flexure.

Results:

105 patients were identified, median follow up 5 years. 90 patients underwent video capsule endoscopy (VCE); 56 MR enterography (MRE); 8 CT enterography and one a barium follow-through. One patient had a significant polyp missed on VCE, subsequently found to be causing intussusception on MRE.

53 patients required intervention. 65 double balloon enteroscopies (DBE) were performed on 41 patients, of which 10 required laparoscopic assistance (due to adhesions preventing scope insertion or preventing adequate snare position). Nine patients had more than one DBE within the same year to achieve polyp clearance; two of these patients went on to laparotomy and intraoperative enteroscopy (IOE). 13 laparotomies with IOE were performed in 12 patients.

One patient having a DBE for an intussuscepting polyp suffered a SB perforation requiring immediate laparotomy and another was admitted locally the next day with an ileus. Four patients who had laparoscopic assisted DBE required an enterotomy to complete polypectomy (via the SILS port incision in three; a mini laparotomy was required in one). Two patients in the laparotomy and IOE group suffered complications – one developed lower limb compartment syndrome requiring fasciotomy and one an infected wound haematoma requiring return to theatre and washout. Median length of stay for the laparoscopic assisted DBE group was 2.5 nights (range 1-6) and laparotomy and IOE 8 nights (range 4-16). Most DBEs without laparoscopic assistance were performed as a day case.

During the study period one patient was admitted acutely with SB obstruction from an intussuscepting polyp requiring SB resection.

Conclusion:

Our current SB surveillance of patients with PJS appears to prevent SB obstruction from intussuscepting polyps. DBE and laparotomy with IOE both have merits as the modality of intervention; patient selection is crucial.

OC88 - TIME TO RELAX COLONOSCOPY SURVEILLANCE RECOMMENDATIONS FOR NEW ZEALAND MSH6 & PMS2 MUTATION CARRIERS

T. Chalmers-Watson¹, M. Stevenson¹, C. Wakeman¹, M. Kiesanowski¹, B. Dobbs², S. Parry³

¹Canterbury District Health Board, New Zealand Familial Gastrointestinal Cancer Service Christchurch, ²Canterbury District Health Board, Christchurch, ³Auckland District Health Board, New Zealand Familial Gastrointestinal Cancer Service Auckland

Background Lynch Syndrome defined by the presence of a germline mutation in a mismatch repair gene (MMR) is the commonest cause of inherited colorectal cancer (CRC). MSH6 and PMS2 mutation carriers have recently been reported to have a lower risk of CRC with a later age of presentation. The New Zealand Familial Gastrointestinal Cancer Service (NZFGCS) recommends annual surveillance colonoscopy from age 25yrs for all individuals with Lynch Syndrome regardless of MMR involved. Our aim was to assess the outcome of surveillance colonoscopy in MSH6 and PMS2 mutation carriers under our service.

Methods The NZFGCS has a prospectively maintained national database of Lynch Syndrome patients. Data regarding MSH6 and PMS2 mutation carriers was extracted on 01/10/2016 and a finding of CRC or advanced adenoma (adenoma > 10mm, high grade dysplasia or villous histology) was recorded for each surveillance colonoscopy.

Results 135 MSH6 mutation positive patients (pts) were identified from 39 MSH6 families. Of those 39 families the index case presented with CRC in 23 families (59%), 18 male (mean age 48.9yrs) and 5 female (mean age 62.4yrs). Youngest age CRC 30 yrs. 14 cases presented with a gynecological cancer (mean age 49.5yrs) and 1 case presented with a urological cancer aged 86yrs. Only pts with no personal history of CRC or colorectal surgery were included for analysis making a total of 92 pts. These 92 pts had 311 colonoscopies, over a mean period of 4.2yrs at a mean interval of 13.5 months. Advanced colorectal neoplasia was detected at 6 of 311 procedures (1.9%) in 6 separate pts. This included 2 pts with CRC (one male diagnosed at 64yrs and one female diagnosed at 44yrs) and 4 with advanced adenomas at mean age of 65yrs. There was no advanced neoplasia identified under 30yrs.

37 PMS2 mutation positive pts were identified from 15 PMS2 families. Of those 15 families the index case presented with CRC in 14 families (93%), 9 male (mean age 50.9yrs) and 5 female (mean age 45.4yrs). Youngest age CRC 25 yrs. 1 case had presented with endometrial cancer aged 65yrs. From these families 20 patients were included for analysis. These 20 pts underwent 76 colonoscopies over a mean period of 5.3 years at a mean interval of 16.5 months. Advanced neoplasia was detected in 1 of 76 procedures (1.3%) in a pt aged 65 yrs (adenomas > 10mm). No CRC was diagnosed.

The combined advanced neoplasia detection rate at colonoscopy for MSH6 and PMS2 mutation carriers was 1.8%.

Conclusion CRC or advanced adenoma was only detected in 7 of 112 (6.3%) MSH6 & PMS2 mutation carriers undergoing a total of 387 colonoscopies at a mean interval of 14 months. No CRC or advanced adenomas were detected during surveillance in those under 30yrs. This data would, in line with international evidence, support a move in NZ to commence colonoscopy surveillance in MSH6 and PMS2 mutation carriers at the older age of 30yrs, providing no young index CRC, and extend the interval to 2 years.

OC92 - CLINICAL AND MOLECULAR CHARACTERISTICS IN 130 PATIENTS WITH MUTYH-ASSOCIATED POLYPOSIS: RESULTS FROM AN HEREDITARY POLYPOSIS REGISTRY

M. T. Ricci¹, M. Moschitta¹, V. Pensotti², F. Mariette², G. De Vecchi², P. Radice³, V. Gismondi⁴, L. Varesco⁴, S. Signoroni¹, L. Bertario¹, M. Vitellaro⁵

¹Hereditary Digestive Tract Tumours Unit, Dep. of Preventive and Predictive Medicine, Fondazione IRCCS Istituto Nazionale dei Tumori Milano, Italy, ²IFOM, Fondazione Istituto FIRC di Oncologia Molecolare; Cogentech Cancer Genetics Test Laboratory Milano, Italy, ³Molecular Bases of Genetic Risk and Genetic Testing Research Unit, Dep. of Preventive and Predictive Medicine, Fondazione IRCCS Istituto Nazionale dei Tumori Milano, Italy, ⁴Unit of Hereditary Cancer, IRCCS AOU San Martino-IST Genova, Italy, ⁵Hereditary Digestive Tract Tumours Unit, Dep. of Preventive and Predictive Medicine; Colorectal Surgery Unit, Dep. of Surgery, Fondazione IRCCS Istituto Nazionale dei Tumori Milano, Italy

Aim: To describe clinical features, mutation spectrum and genotype-phenotype correlations in a cohort of patients (pts) with MAP (*MUTYH*-Associated Polyposis).

Method: Retrospective review of clinical information and genotype data of all pts with genetically confirmed MAP included in the Hereditary Colorectal Cancer Registry at Fondazione IRCCS Istituto Nazionale dei Tumori, Milano.

Results: A total of 130 MAP pts (66 males and 64 females), belonging to 98 families, were identified: the mean age at polyp diagnosis was 46.1 years (range 21-70), and in most cases (63.8%) pts were symptomatic at diagnosis. Twenty-eight pts (21.5%) presented with more than 100 polyps and 52 (40%) showed mixed polyposis. In 75 out of 130 pts (57.7%) CRC was observed at the time of diagnosis (54 cases with single CRC and 21 cases with multiple CRCs): fifty-nine of these pts (78.7%) presented with less than 100 polyps and left-sided CRCs were more prevalent (55.3%). Moreover, 25 pts developed CRC during follow up. Overall, 116 pts (89.2%) underwent a surgical treatment and in 67.2% of cases a total colectomy was performed. Among the 102 pts (78.5%) who underwent upper gastrointestinal (UGI) scope, 14 (13.7%) presented UGI adenomas (13 duodenal and one gastric) with a mean age at adenoma diagnosis of 52.3 years (range 39-72). In four pts (3.1%) cancers of the UGI tract were reported (three of the small bowel and one gastric) while extra-intestinal malignancies (n=31) were diagnosed in 23 out of 130 pts (17.7%). Concerning genotype, a total of 17 different *MUTYH* pathogenic variants were identified (two never described before). The most frequent were Y179C, G396D and E480del with allele frequencies of 33.5%, 22.7% and 11.1%, respectively. Noteworthy, 27 out of 130 pts (20.8%) did not harbor any of these frequent variants. MAP pts carrying at least one Y179C variant (n=61) were younger at diagnosis as compared to pts not carrying the Y179C variant (P=0.028).

Conclusion: Phenotype of our cohort of MAP pts is consistent with previous reports: MAP should be suspected also in pts with more than 100 polyps or with mixed polyposis, and pts carrying the Y179C variant showed a peculiar early onset of colorectal disease. In view of the high rate of CRC at diagnosis, colorectal screening is mandatory and its beginning should be tailored also by considering the genotype. In addition, our data confirm the importance of UGI surveillance.

OC93 - COMPREHENSIVE HISTOLOGICAL AND MOLECULAR ANALYSIS OF PMS2 ASSOCIATED MALIGNANCIES; A SEPARATE ENTITY AMONG MMR DEFICIENT TUMOURS?

S. W. ten Broeke¹, T. van Bavel¹, A. M. Jansen², E. Gomez Garcia³, L. P. van Hest⁴, T. G. Letteboer⁵, M. J. Olderode-Berends⁶, T. A. van Os⁷, L. Spruijt⁸, J. J. Tromp¹, J. T. Wijnen¹, F. J. Hes¹, H. Morreau², T. van Wezel², M. Nielsen¹

¹Clinical Genetics - Leiden University Medical Center Leiden, ²Pathology - Leiden University Medical Center Leiden, ³Clinical Genetics - Maastricht University Medical Center Leiden, ⁴Clinical Genetics - VU Amsterdam Amsterdam, ⁵Clinical Genetics - University Medical Center Utrecht Utrecht, ⁶Clinical Genetics - University Medical Center Groningen Groningen, ⁷Clinical Genetics - Academic Medical Center Amsterdam, ⁸Clinical Genetics - Radboud University Medical Center Nijmegen

Background Lynch syndrome (LS) related cancers have a different genetic background and histology compared to sporadic colorectal cancers (CRC) and show a different treatment response and survival. Up to now most studies focussed on MLH1, MSH2 and MSH6 carriers, but data on PMS2 associated tumours is currently lacking. We now aim to unravel the histological and molecular hallmarks of PMS2 associated CRC.

Methods We obtained informed consent of PMS2 mutation carriers and were able to collect 20 CRCs for analysis. Histological hallmarks were scored by an experienced pathologist. Moreover, to get an impression of the somatic tumour spectrum, we used the Ampliseq Cancer Hotspot panel (version 2) on isolated tumour DNA. This panel covers mutation hotspots in 50 genes (~2800 COSMIC mutations), including well known somatically mutated genes such as KRAS, APC and TP53. The same panel was used to analyse control cohorts consisting of MLH1 mutation carriers and sporadic CRC. Identified variants were also validated in a control cohort of CRCs with (sporadic) MLH1 promotor hypermethylation, which were previously analysed with a panel of similar coverage.

Results PMS2 associated CRCs showed a number of LS associated hallmarks: 81% were right-sided, 43% had Crohn's like infiltrate (missing: 15%) and 81% (missing: 15%) showed microsatellite instability. However, a majority (65%) hardly had any tumour infiltrating lymphocytes, a well-known hallmark of Lynch associated tumours. The molecular analysis showed a relatively low proportion of TP53 and APC mutations compared with sporadic controls and a high percentage of a specific FBXW7 mutation (c.1393C>T, p.Arg465Cys). Notably, 5/20 of CRCs had this transition, where the controls had none. We also found a relatively rare KRAS mutation in exon 4 (c.436G>A, p.Ala146Thr) occurring three times in the PMS2 cohort but not in the control cohort and once in MLH1 associated CRCs. Strikingly we found CTNNB1 mutations in 14/25 (60%) of MLH1 associated CRCs, but none in the PMS2 cohort.

Discussion This study illustrates the separate entity of PMS2 associated CRCs, with histological and molecular characteristics that overlap with both MLH1 associated as well as sporadic CRCs. These findings indicate the possibility of a specific route to tumorigenesis in PMS2 carriers, which may have consequences for detection and treatment. Moreover, these observations might also contribute to tailor-made surveillance guidelines for PMS2 mutation carriers.

OC98 - THERAPEUTIC CELLULAR VACCINATION PROLONGS SURVIVAL OF MLH1^{-/-} MICE BY RE-ACTIVATING SPECIFIC ANTITUMORAL IMMUNE RESPONSES

C. Maletzki¹, J. Stenzel², T. Lindner², S. Polei², B. Vollmar², B. Krause², E. Klar³, M. Linnebacher¹

¹Molecular Oncology and Immunotherapy, Department of General Surgery Rostock, ²Core facility multimodale small animal imaging Rostock, ³Department of General Surgery Rostock

Background/Purpose. Mismatch-repair deficiency (MMR-D) is closely linked to hypermutation and accordingly, high immunogenicity. Hence, MMR-D-related tumors constitute ideal vaccination targets both for therapeutic and prophylactic approaches. Here, the therapeutic impact of a cellular vaccine on gastrointestinal tumor (GIT) growth and the tumor-immune microenvironment was studied in a murine MLH1^{-/-} knockout mouse model.

Methods. Mice with confirmed GIT (by PET/CT imaging, weight curve, and multicolor flow cytometry) received four weekly injections of a cellular vaccine (lysate of a GIT allograft, 10mg/kg bw, +/- CpG ODN 1826 or control, n=6 mice/group), followed by biweekly boosts (2.5mg/kg bw) until tumor progression. Tumor growth and immune responses were monitored (multicolor flow cytometry, IFN γ ELISpot and cytotoxicity assay). The tumor-immune microenvironment of resected specimen was analyzed by immunofluorescence.

Results. Therapeutic application of the lysate (+/- CpG ODN 1826) significantly prolonged overall survival (15.5 (Lysate) and 17.3 weeks (Lysate + CpG ODN) vs. 3 weeks (control group), respectively) along with reduced tumor burden and immune stimulation (increased T_{EM}⁻ and NK cell numbers, reduced levels of CD366⁺ cells in both treatment groups). Coding microsatellite analysis of MSI target genes revealed increased mutational load upon vaccination (total mutation frequency within 28 genes: 28.6% vaccine groups vs. 14.9% control group, respectively). As determined by IFN γ ELISpot, reactive T cells specifically recognized tumor lysates used for vaccination and autologous tumor cells with even a higher frequency. T cells were also able to efficiently kill MLH1^{-/-} tumor targets. Assessment of tumor microenvironment revealed massive infiltration of immune cells, predominantly CD8⁺ T and CD19⁺ B-cells, simultaneously expressing LAG-3, but not PD-1. NK cells and myeloid-derived suppressor cells could however not be detected.

Conclusions. The present study is the first reporting *in vivo* results on a therapeutic cellular MSI⁺ vaccine. We were able to show that a cellular lysate prolongs survival in a clinically-relevant mouse model for MMR-D-related diseases by long-term impairment of tumor growth likely attributable to the observed re-activated immune responses. Ongoing trials focus on improvement of the treatment protocol by using combined chemo-immunotherapy.

OC100 - INDICATIONS FOR COLECTOMY AND FACTORS INFLUENCING TIME TO COLECTOMY IN CHILDREN AND YOUNG ADULTS WITH FAMILIAL ADENOMATOUS POLYPOSIS (FAP)

S. Sarvepalli¹, C. Burke², L. Laguardia², M. O'Malley², J. Church²

¹Medicine Institute, Cleveland Clinic Cleveland, Ohio, USA, ²Sanford R. Weiss MD Center for Hereditary Colorectal Neoplasia, Digestive Diseases Institute, Cleveland Clinic Cleveland, Ohio, USA

Introduction

Colectomy is the primary modality of colorectal cancer prevention in FAP, but has significant impact on the lifestyle of the young, usually asymptomatic patients. The optimal timing of the operation and the type of procedure to be performed are determined by the balance of two main priorities: preventing cancer and maintaining quality of life. This study assessed the surgical indications and time of colectomy based on initial number of polyps and individual genotype.

Methods

The records of all FAP patients < 30yrs were obtained from the IRB approved David G. Jagelman Inherited Colorectal Cancer Registry CologeneTM database. We ascertained the indication for surgery according to the American College of Gastroenterology guideline: documented or suspected cancer, significant symptoms, multiple adenomas >6 mm, significant increase in adenoma number, high grade dysplasia and multiple diminutive polyps. We assessed the frequency and time to colectomy based upon genotype predicted colonic phenotype according to InSIGHT's LOVD database (classic, severe, attenuated and uncharacterized); and number of polyps on initial colonoscopy (Group 1 = 0 to 20, Group 2 =21 to 99, Group 3 = >99). After performing X² -analysis to assess for differences in frequencies between groups, survival analysis was done to determine time to colectomy for each of the groups.

Results

Of the 82 patients, 31 (38%) underwent surgery. Of these, 28 underwent colectomy with ileorectal anastomosis (IRA) and 3 underwent proctocolectomy and ileal pouch anal-anastomosis (IPAA). After undergoing IRA none of the 28 patients needed IPAA (mean follow up 9 years). The most common reason for surgery was increase in polyp number (20/31), followed by multiple small polyps (12/31), multiple larger polyps (12/31) and symptoms (1/31). No patient had a suspicious lesion or cancer. There were significant differences between the colectomy and non-colectomy groups in genotype (p=0.031) and baseline polyp numbers (p=<0.001) based on X² analysis. Survival analysis showed significant differences in time to colectomy between these groups (Figure 1). Overall time to colectomy was 4.56 years.

Conclusion

The commonest indication for colectomy was progressive polyposis, in number or size. Time to colectomy was function of genotype and number of polyps at initial colonoscopy. This information can help patients and surgeons delineate the course of treatment based on better understanding of their disease course.

FIGURE 1- Percent of individuals with FAP undergoing colectomy over time, grouped by genotype predicted colonic phenotype (1) and number of polyps at initial colonoscopy (2)

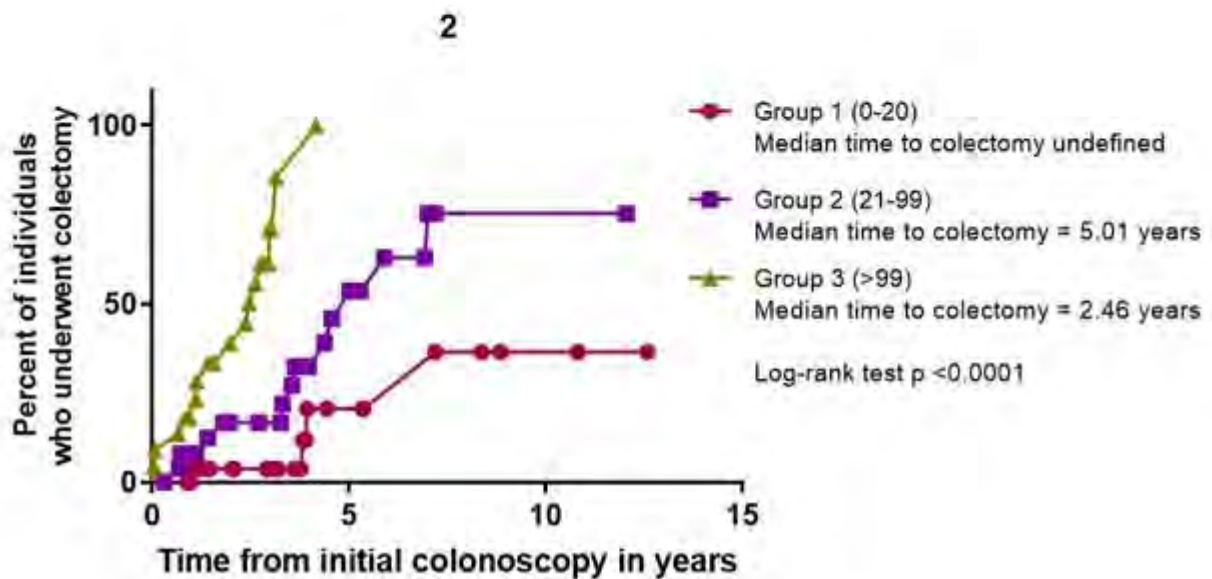
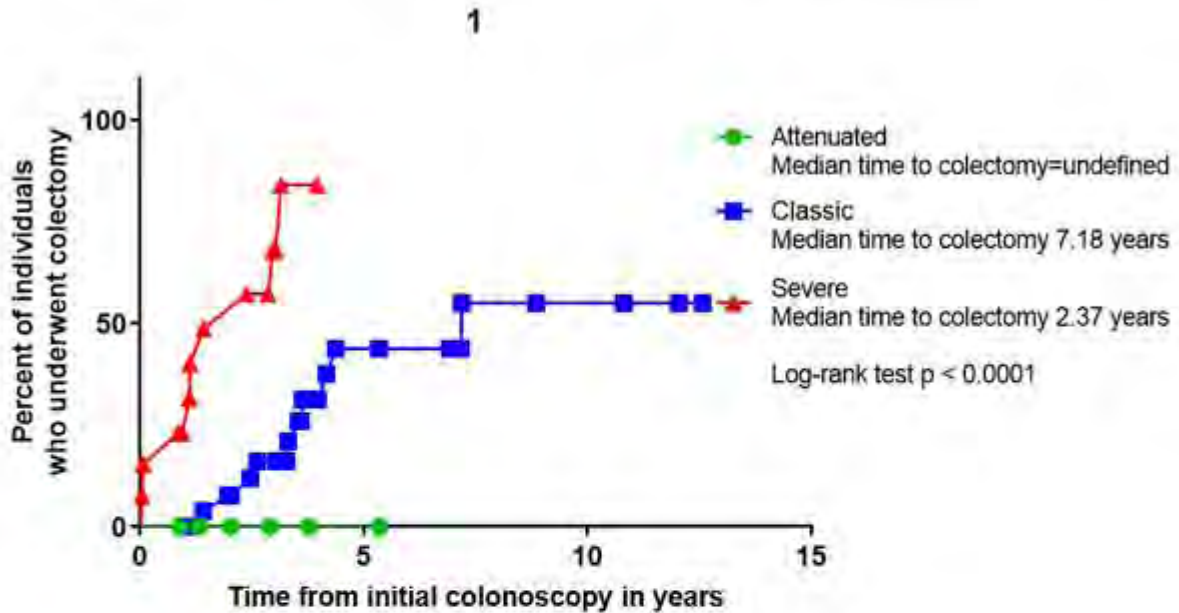

OC102 - IMPLICATION OF GERMLINE MUTATIONS IN POLE AND POLD1 IN SEVERAL FORMS OF HEREDITARY CANCER

L. Valle¹, A. Vidal², G. Cinnirella³, E. Mart n-Ramos⁴, M. Pineda⁵, R. Sanz-Pamplona⁶, F. Quiles⁵, G. Aiza⁵, M. Men ndez⁵, S. Gonz lez⁷, M. Navarro⁵, S. Belhadj⁵, P. Mur⁵, J. Balma a⁸, J. Brunet⁹, V. Moreno⁶, R. Aligu a⁴, G. Capell i⁵, C. L jzar ⁵

¹ Hereditary Cancer Program, Catalan Institute of Oncology, IDIBELL and CIBERONC, Barcelona, Spain, ² Department of Pathology, Bellvitge University Hospital, IDIBELL, Barcelona, Spain, ³ Hereditary Cancer Program, Catalan Institute of Oncology, IDIBELL; PhD Program in Translational Biomedicine, University of Catania, Catania, Italy, ⁴ Department of Biomedical Sciences, School of Medicine, University of Barcelona, IDIBAPS, Barcelona, Spain, ⁵ Hereditary Cancer Program, Catalan Institute of Oncology, IDIBELL and CIBERONC, Barcelona, Spain, ⁶ Unit of Biomarkers and Susceptibility, Catalan Institute of Oncology, IDIBELL and CIBERESP, Barcelona, Spain, ⁷ Hereditary Cancer Program, Catalan Institute of Oncology, IDIBELL and CIBERONC Barcelona, Spain, ⁸ Oncology Department, Vall d'Hebron University Hospital, Vall d'Hebron Institute of Oncology (VHIO), Barcelona, Spain, ⁹ Hereditary Cancer Program, Catalan Institute of Oncology, IDIBGi, Girona, Spain

Germline mutations in the exonuclease domains of *POLE* and *POLD1* predispose to adenomatous polyps, colorectal cancer and endometrial tumors. Recent findings suggest that the phenotypic spectrum associated to *POLE* and *POLD1* mutations is not limited to the above-mentioned malignancies. We sequenced the exonuclease domains of both genes in 547 unrelated cancer-affected patients without mutations in known cancer-predisposing genes, studied according to the phenotypic characteristics of the family, including: 192 patients from high-risk breast/ovarian cancer families; 143 patients with personal and/or familial cancer history of breast/ovarian cancer and colorectal/endometrial/small intestine/gastric cancer; 119 *TP53*-negative patients derived for germline *TP53* mutation screening; 34 patients with familial or personal history of multiple tumors; 34 patients with personal and/or familial cancer history brain/breast/endometrium/skin and colonic polyps (>5-10); and 25 patients with personal and/or familial cancer history of brain cancer in combination with other tumors. Mutation screening was carried out by direct automated sequencing. Variants located within the exons or in the 10-nucleotide flanking regions and a population MAF<1% were selected for further analyses.

One frameshift, 4 missense and 2 synonymous variants were identified in the exonuclease domain of *POLE* in unrelated families. In the case of *POLD1*, one frameshift, one potential splice-site and 3 synonymous variants were identified within the exonuclease domain. Moreover, *POLD1* c.883G>A (p.V295M), outside but close to the exonuclease domain and which had been reported in two additional CRC families, was identified in three families. Also, a germline *POLD1* missense variant located outside the exonuclease domain (c.2515C>A; p.L839I) and identified in an 8 year-old child with multiple brain tumors was included in the study. Variants predicted to affect splicing were subjected to RNA study. Whenever possible, co-segregation analyses were performed. Based on RNA studies and co-segregation results, 3 missense and one frameshift variants in *POLE*, the frameshift mutation in *POLD1*, and *POLD1* c.2515C>A (p.L839I), remained as potential pathogenic variants and are currently being functionally tested (*ade6-485* allele reversion rates assessment in yeast, and tumor whole-exome sequencing for the identification of the ultramutated phenotype).

This study will provide insight to the implication and prevalence of polymerase-proofreading associated mutations in different forms of hereditary cancer and will help elucidate the relevance and functional significance of disrupting mutations and mutations located outside the exonuclease domain; issues that have not yet been solved.

OC105 - 'MMR DEFICIENCY FIRST' – RE-APPRAISING THE PATHOGENESIS OF LYNCH SYNDROME CANCERS

A. Ahadova¹, R. Gallon², A. Ballhausen¹, H. Blaeker³, J. Burn², M. von Knebel Doeberitz¹, M. Kloor¹

¹Department of Applied Tumor Biology, Institute of Pathology, University Hospital Heidelberg Heidelberg, ²Institute of Genetic Medicine, Newcastle University Newcastle, ³Institute of Pathology, Charité University Hospital Berlin

Background:

DNA mismatch repair (MMR) deficiency in Lynch syndrome cancers is caused by the combination of a germ line mutation and a second somatic hit inactivating the remaining functional MMR gene allele. Traditionally, these second hits have been regarded as late somatic events occurring in already initiated lesions, such as colorectal adenomas. We have recently provided evidence that MMR-deficient crypts occur very frequently in the healthy intestinal mucosa of Lynch syndrome mutation carriers, although their relevance as cancer precursors remained unclear. In order to determine the possible fate of MMR-deficient crypts, we evaluated Lynch syndrome colorectal cancers and adenomas for potential clues regarding their origin and history of progression.

Materials and Methods:

Colorectal cancer (n=46) and polyps (n=42) from Lynch syndrome mutation carriers were analyzed for MMR protein expression in tumor and adjacent normal cells. We performed mutational profiling of Lynch syndrome-associated cancers with evidence for polypous or non-polypous growth, using a panel that covers 29 classical colorectal cancer-related genes and 27 coding microsatellite-containing target genes.

Results:

MMR deficiency was observed in 46 (100%) out of 46 Lynch syndrome-associated colorectal cancers and 22 (88%) out of 25 analyzable dysplastic adenomas. In four of the analyzed lesions, it was possible to detect normal appearing MMR-deficient crypts in direct connection to either dysplastic adenoma or intramucosal carcinoma formations. This novel finding indicates that loss of MMR protein expression can in fact precede the formation of morphological changes. Mutational profiling of MMR-deficient cancers revealed that *APC* mutations were common in polypous cancers, whereas *CTNNB1* mutations were significantly more frequent in non-polypous cancers, which also frequently harbored *TP53* and *KRAS* mutations.

Conclusions:

In summary, we provide evidence that MMR-deficient crypts as cancer precursors can give rise to MMR-deficient adenomas and cancers. Although the majority of MMR-deficient crypts are expected to regress or be eliminated, a subset is predicted to possess the potential to develop either into dysplastic adenomas, or immediately into non-polypous invasive cancers. The latter may be relevant for interval cancer formation in Lynch syndrome, as they may escape detection by colonoscopy. This underscores the importance of primary prevention methods in Lynch syndrome.

OC107 - IMMUNE EVASION IN MSI COLORECTAL CANCERS IS RELATED TO DENSE INFILTRATION WITH ACTIVATED PD-1-POSITIVE T CELLS

M. Kloor¹, J. Janikovits¹, A. Ahadova¹, A. Ballhausen¹, F. Echterdiek¹, J. Krzykalla², A. Benner², M. von Knebel Doeberitz¹
¹Department of Applied Tumor Biology, Institute of Pathology, University Hospital Heidelberg Heidelberg, ²Department of Biostatistics, DKFZ Heidelberg

Background and Aims:

Lynch syndrome-associated cancers show microsatellite instability (MSI) and accumulate high numbers of mutations at repetitive sequence stretches as a consequence of DNA mismatch repair (MMR) deficiency. The high mutational load of MSI cancers leads to the generation of multiple highly immunogenic frameshift peptide (FSP) neoantigens. MSI cancer cells can grow out to clinically manifest cancers, if the local T cells in their environment get exhausted. Therefore, a subset of MSI cancer patients responds particularly well to treatment with immune checkpoint inhibitors such as anti-PD-1 antibodies. Alternatively, MSI cancer cells that have undergone immune evasion due to loss of HLA-mediated antigen presentation may grow out irrespective of local T cell surveillance. We asked whether HLA-related immune evasion in MSI cancer is related to the local immune cell activation status.

Methods:

Microsatellites located in *Beta2-microglobulin (B2M)* and the HLA class II-regulatory genes *RFX5* and *CIITA* were analyzed for mutations in MSI colorectal cancer specimens (n=53). HLA class I and II antigen expression was examined by immunohistochemistry. In addition, tumor-infiltrating lymphocytes (CD3-positive T cells, PD-1-positive T cells) were quantified using a semi-automated system.

Results:

We related *B2M* mutation and HLA class II antigen expression status of MSI colorectal cancer specimens (n=56) to CD3- and PD-1 positive T cell infiltration in the tumor. PD-1-positive T cell infiltration was significantly higher in *B2M*-mutant (mt) compared to *B2M*-wild type (wt) tumors (median: 22.2 cells per 0.25 mm² in *B2M*-mt vs. 2.0 cells per 0.25 mm² in *B2M*-wt, Wilcoxon's rank sum test p=0.002). Increasing PD-1-positive T cell infiltration was significantly related to an increased likelihood of *B2M* mutation and loss of HLA class I antigen expression (OR=1.81). In contrast, HLA class II antigen expression status was not related to the proportion of PD-1-positive lymphocytes, but significantly associated with enhanced overall T cell infiltration.

Conclusions:

These results suggest that immune evasion mediated by *B2M* mutation-induced loss of HLA class I antigen expression predominantly occurs in an environment of activated PD-1-positive T cell infiltration, supporting the validity of the immunoediting concept in MSI colorectal cancers. If *B2M* mutations interfere with anti-PD1/PD-L1 therapy success, we predict that resistance towards anti-PD1 therapy may – counterintuitively – be particularly common in MSI cancer patients with high PD-1-positive T cell infiltration.

OC108 - EXOME SEQUENCING IDENTIFIES BIALLELIC MSH3 GERMLINE MUTATIONS AS RECESSIVE SUBTYPE OF COLORECTAL ADENOMATOUS POLYPOSIS

I. Spier¹, R. Adam², B. Zhao³, M. Kloth⁴, J. Marquez³, I. Hinrichsen⁵, J. Kirfel⁶, A. Tafazzoli⁷, S. Horpaopan⁸, S. Uhlhaas⁹, D. Stienen⁹, N. Friedrichs⁴, J. Altmüller¹⁰, A. Laner¹¹, S. Holzapfel¹, S. Peters⁹, K. Kayser⁹, H. Thiele¹⁰, E. Holinski-Feder¹¹, G. Marra¹², G. Kristiansen⁶, M. M. Nöthen⁷, R. Böttner⁴, G. Malslein¹³, R. C. Betz⁷, A. Brieger⁵, R. P. Lifton³, S. Aretz¹

¹Institute of Human Genetics and Center for Hereditary Tumor Syndromes, University of Bonn, Bonn, Germany, ²Institute of Human Genetics, University of Bonn, Bonn, Germany; Center for Experimental and Molecular Medicine, Academic Medical Center Amsterdam, Amsterdam, Netherlands, ³Department of Genetics, Howard Hughes Medical Institute, Yale University School of Medicine, New Haven, USA, ⁴Institute of Pathology, University of Cologne, Cologne, Germany, ⁵Medical Clinic 1, Biomedical Research Laboratory, Goethe-University Frankfurt, Frankfurt, Germany, ⁶Institute of Pathology, University of Bonn, Bonn, Germany, ⁷Institute of Human Genetics and Department of Genomics, Life & Brain Center, University of Bonn, Bonn, Germany, ⁸Institute of Human Genetics, University of Bonn, Bonn, Germany; Department of Anatomy, Faculty of Medical Science, Naresuan University, Phitsanulok, Chiang Mai, Thailand, ⁹Institute of Human Genetics, University of Bonn, Bonn, Germany, ¹⁰Cologne Center for Genomics (CCG), University of Cologne, Cologne, Germany, ¹¹Medizinische Klinik und Poliklinik IV, Ludwig-Maximilians-University (LMU) and Medical Genetics Center, Munich, Germany, ¹²Institute of Molecular Cancer Research, University of Zurich, Zurich, Switzerland, ¹³HELIOS Klinikum Wuppertal, University of Witten/Herdecke, Wuppertal, Germany

Background: In around 30% of families with colorectal adenomatous polyposis, no germline mutation in the known genes *APC*, *MUTYH*, *POLE*, *POLD1*, or *NTHL1* can be identified, although a hereditary etiology is likely.

Methods: To uncover further genes with high-penetrance causative mutations, exome sequencing of leukocyte DNA from 102 unrelated individuals with unexplained adenomatous polyposis was performed. For data analysis and variant filtering an established bioinformatics pipeline including in-house tools was applied.

Results: We identified two unrelated individuals with differing compound-heterozygous loss-of-function germline mutations in the mismatch repair gene *MSH3*. The impact of the *MSH3* mutations (c.1148delA, c.2319-1g>a, c.2760delC, c.3001-2a>c) was indicated on RNA and protein level. Analysis of the tumor tissue demonstrated high microsatellite instability of di- and tetranucleotides (EMAST) and immunohistochemical staining illustrated a complete loss of nuclear MSH3 in normal and tumor tissue, confirming the loss-of-function effect and causal relevance of the mutations. The pedigrees, genotypes, and the frequency of *MSH3* mutations in the general population are consistent with an autosomal recessive mode of inheritance. Both index persons had an affected sibling carrying the same mutations. The tumor spectrum in these four persons comprised colorectal and duodenal adenomas, colorectal cancer, gastric cancer, and an early-onset astrocytoma. Additionally, we detected one unrelated individual with biallelic *PMS2* germline mutations, representing Constitutional Mismatch Repair Deficiency Syndrome (CMMRD).

Conclusions: This is the first study that identified biallelic loss-of-function germline mutations of *MSH3* in individuals with a suspected hereditary tumor syndrome. Our data suggest that *MSH3* mutations represent an additional recessive subtype of colorectal adenomatous polyposis. Consistent with previous data, unexplained tumor syndromes appear to show extreme genetic heterogeneity, and large patient cohorts are therefore warranted to identify recurrently mutated genes. Further cases are needed to explore the phenotypic spectrum of this novel condition.

OC109 - FIRST REPORT ON LONG TERM FOLLOW UP (>10 YEARS) OF PATIENTS WITH MILD POLYPOSIS COLI.

E. D. L. urso¹, A. maritan¹, F. giandomenico², F. celotto¹, T. gavaruzzi³, I. mammì⁴, M. agostini⁴, M. zorzi⁵, L. lotto³, S. pucciarelli¹
¹azienda ospedaliera università di padova, clinica chirurgica 1^a padova, italy, ²universita di padova, Dipartimento di Psicologia dello sviluppo e della socializzazione padovaitaly, ³universita di padova, Dipartimento di Psicologia dello sviluppo e della socializzazione padova, italy, ⁴istituto oncologico veneto, irccs, unit^À tumori ereditari padova, italy, ⁵registro tumori del veneto padova, italy

Patients (pts) with multiple colorectal adenomas (MCRAs) (10-100 polyps) are genetically heterogeneous: APC or biallelic MutYH mutations can be found, while the majority of pts have no mutations. Colorectal cancer (CRC) risk is high, but treatment is not yet defined and treatment related complications, long term quality of life (QoL) and bowel function results have never been reported.

Aim. To collect information on long term follow up of MCRAs pts, regarding incidence of CRC and other tumors, treatments, their related complications and data on QoL and bowel function.

Methods. We considered MCRAs patients (10 to 100 polyps) enrolled at our Centre, if the diagnosis of polyposis was done before 30 July 2006. To all MCRAs pts was offered APC and MYH sequencing. The follows were recorded: age at diagnosis, gender, polyps number at first colonoscopy, type of mutation found, CRC, non colonic tumors, 1st degree relatives with CRC and with polyposis, treatment as: A-surgery (A1: colectomy or A2: segmental resection) vs B-endoscopic management, surgical and endoscopic severe complications (Clavien Dindo grade \geq II), mortality. The EORTC-QoL C30 and CR29 and MSCCC questionnaires, were sent to live patients, to investigate QoL and bowel function. Significant differences if $p < 0.05$.

Results. 52 pts, M/F: 33/19; median age: 49 (13-73) yrs; median polyps n^o 30 (10-100); mutations: APC, Biallelic MutYH and none found in 2 (4%); 15 (29%), 35 (67%) pts, respectively; CRC and extracolonic tumors in 27 (52%) and 19 cases respectively; surgery: 38 pts (73%), A1: 24 and A2: 14 pts, respectively. 6 severe complications in group A and 6 (12%) in group B occurred. 11 pts (21%) died at a median age of 70 (46-89 yrs) and median time from polyposis diagnosis of 10 (3-23) yrs. Only 2 pts dead for CRC progression, 0 for treatment complications. 33 out of 41 live patients (81%) completed questionnaires: the results are resumed in figure 1, 2 and 3. Comparison of pts with or without CRC and comparison of group A vs B are shown in table 1 and 2, respectively. If comparing the our MCRAs group with general italian population, the RR for extracolonic tumors is 1.34, (95%CI: 0.64-2.93; $p=0.39$)

Conclusions. Incidence of CRC is high and not related to genotype nor to polyps number. MCRAs patients seem have not higher risk than general population for extracolonic tumors- Some 1/3 of MCRAs pts can be managed safely for long time by endoscopy. The efforts for conservative treatment are encouraged by the results of questionnaires on QoL and especially on bowel function, but in time, endoscopic management is related to risk of severe complications much higher than previously reported.

Figure 1. Results of the analysis of EORTC QoL C30 questionnaire

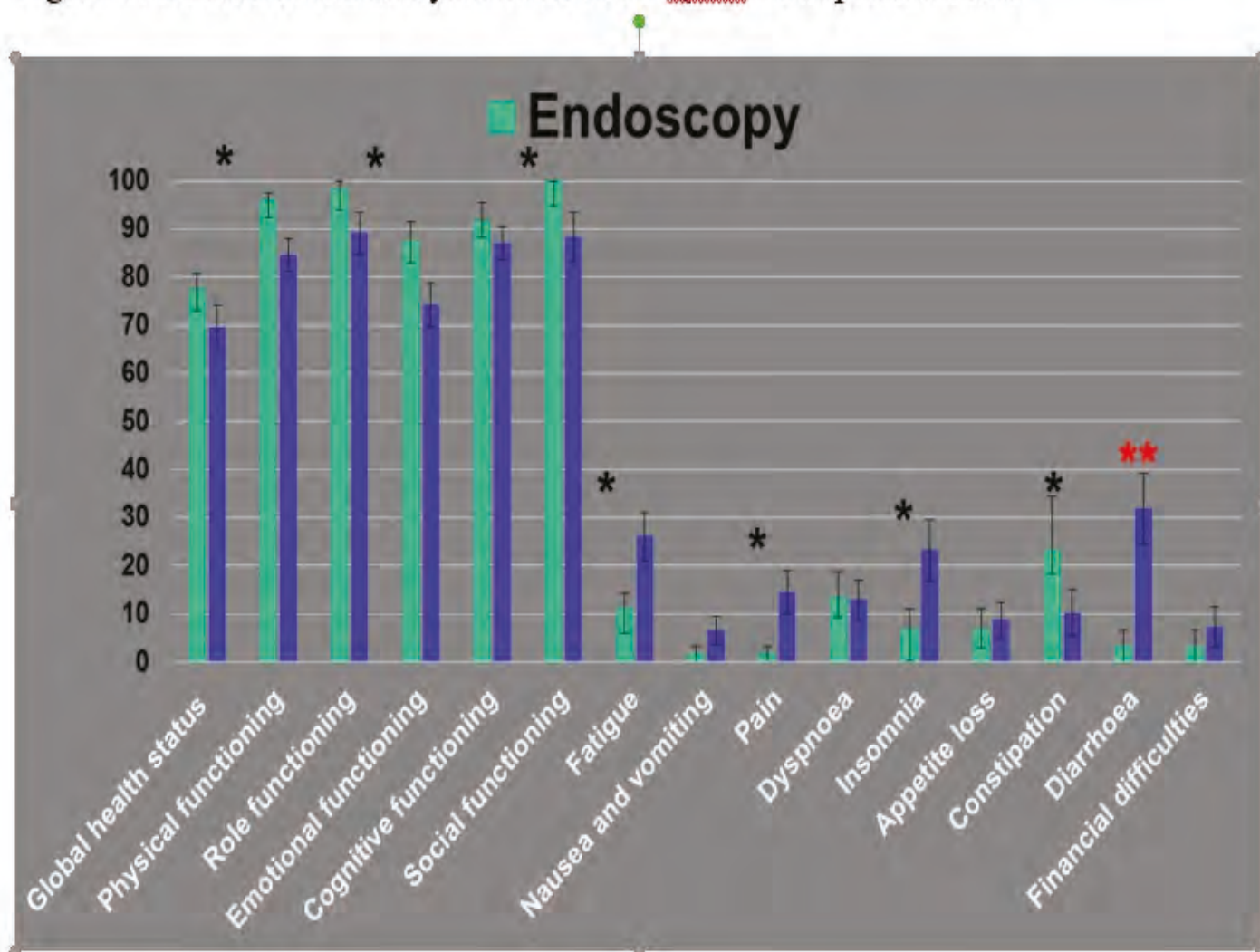

Legend:

*: clinical difference (difference >10 points between groups)

** : statistical difference : p<0.05

light green columns: endoscopy; bleu columns: surgery

Figure 2. Analysis of the results of EORTC QoL CR29 questionnaires

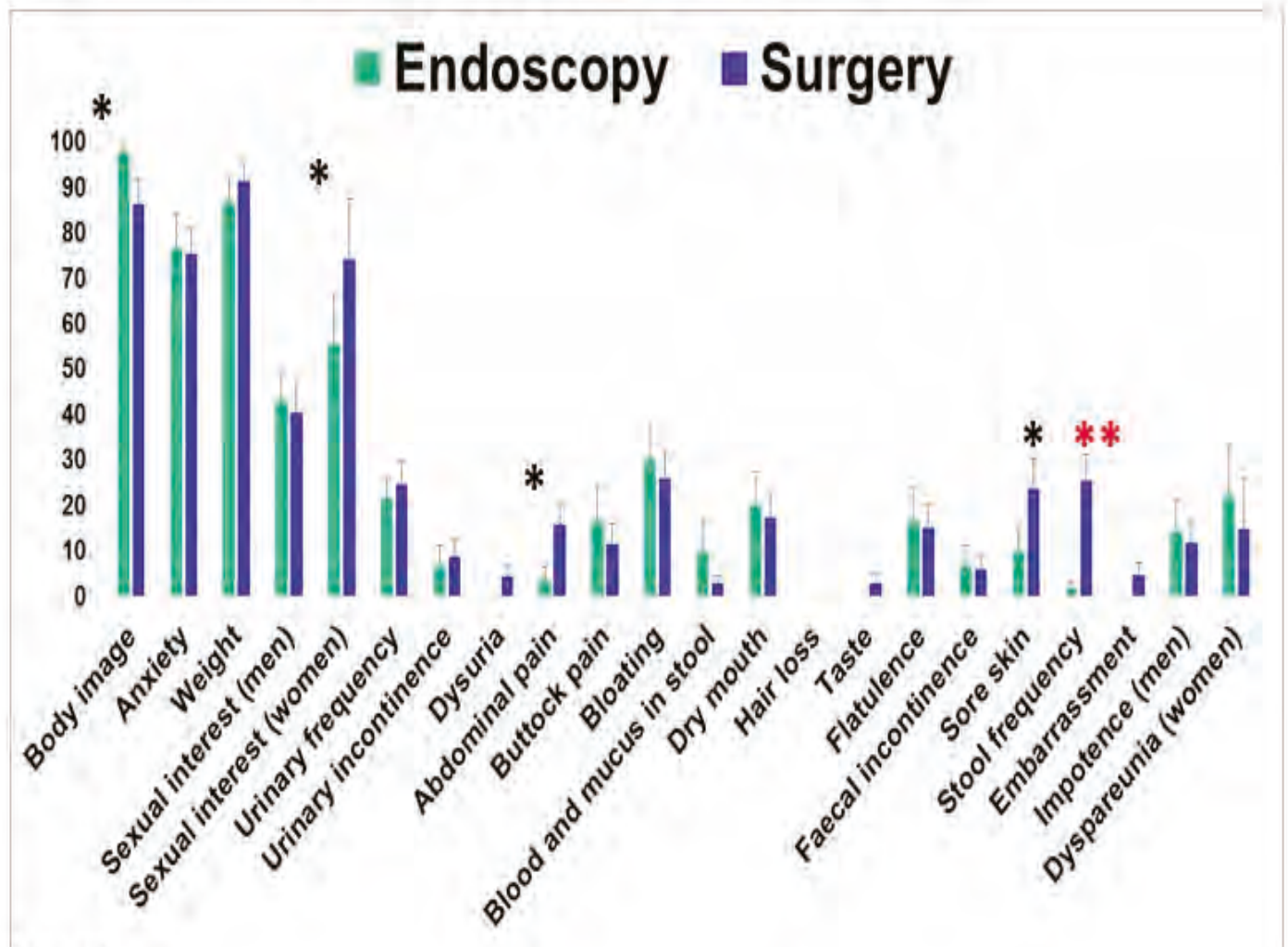

Legend:

*: clinical difference: >10 points between groups

** : statistical difference: p<0.05

light green columns: endoscopy; blue columns: surgery

Figure 3: Analysis of results of the Memorial Sloan Kettering Cancer Center Questionnaire.

Legend:

*: clinical difference: > 10 points between groups

** : statistical difference: $p > 0.05$

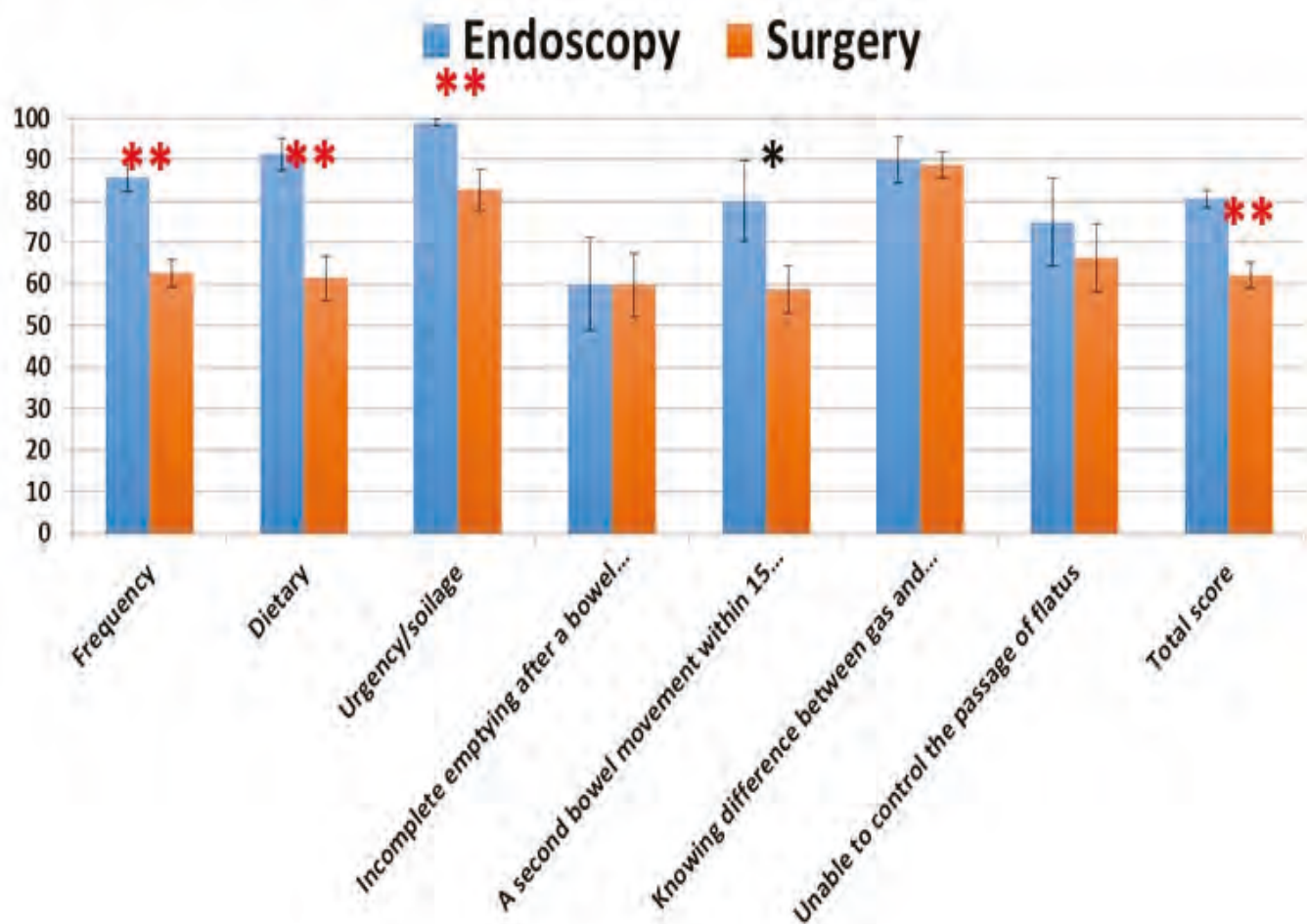

Table 1. Comparison between patients with or without Colorectal cancer (CRC)

	CRC	No CRC	p value
Pts , N°	27	25	
Age at diagnosis of polyposis, median (range)	50 (13-73)	48 (16-70)	0,4654
Gender (Male)	18	15	0.774292
Polyps N°, median (range)	32 (10-100)	19 (10-100)	0,24604
Pathogenetic mutation found, N°	11	5	0.138296
1^ degree relatives with CRC, N°	7	13	0.08653
1^ degree relatives with polyposis	10	14	0.265509
Follow up, in months, median (range)	142 (36-463)	175 (108-427)	0,4654

Table 2. Comparison between patients who underwent surgery (group A) and patients managed by endoscopy (group B).

	<u>Surgery group</u>	<u>Endoscopy group</u>	<u>p value</u>
N. PAZIENTI	38	14	
Age at dignosis of polyposis, median (range)	49 (13-73)	49 (16-63)	0,53526
Gender, Male	25	8	0.746486
Polyps N°, median (range)	31 (10-100)	15 (10-50)	0,25848
Pathogenetic mutation found, N°	14	2	0.178835
1^ degree relatives with CRC, N°	12	8	0.11636
1^ degree relatives with polyposis, N°	17	7	0.763512
Colorectal cancer, N°	26	1	0,000093
Extracolonic tumor, N°	14	5	1
Follow up in months, median (range)	175 (36-463)	139 (108-379)	0,5552

OC115 - LAPAROSCOPIC PROPHYLACTIC SURGERY IN ADOLESCENT PATIENTS WITH FAMILIAL ADENOMATOUS POLYPOSIS (FAP). RESULTS OF 10 YEARS EXPERIENCE

M. Vitellaro¹, M. Scotti², D. Biasoni³, S. Signoroni⁴, M. T. Ricci⁴, P. Verderio⁵, A. Cardani⁶, M. Moschitta⁴, L. Bertario⁴, A. Ferrari⁷

¹Colorectal Surgery Unit, Dep. of Surgery; Hereditary Digestive Tract Tumours Unit, Dep. of Preventive and Predictive Medicine - Fondazione IRCCS Istituto Nazionale dei Tumori Milan, Italy, ²G.I. Surgery and Liver Transplantation Unit, Dep. of Surgery - Fondazione IRCCS Istituto Nazionale dei Tumori Milan, Italy, ³Urologic Surgery Unit, Pediatric Surgery Unit - Dep. of Surgery - Fondazione IRCCS Istituto Nazionale dei Tumori Milan, Italy, ⁴Hereditary Digestive Tract Tumours Unit, Dep. of Preventive and Predictive Medicine - Fondazione IRCCS Istituto Nazionale dei Tumori Milan, Italy, ⁵Medical Statistics and Biometry Unit - Fondazione IRCCS Istituto Nazionale dei Tumori Milan, Italy, ⁶Clinical anesthesia and intensive care Unit, Dep. of Anesthesia, intensive care, pain therapy, and palliative care - Fondazione IRCCS Istituto Nazionale dei Tumori Milan, Italy, ⁷Pediatric Oncology Unit, Dep. of Hematology and Pediatric onco-hematology - Fondazione IRCCS Istituto Nazionale dei Tumori Milan, Italy

Background

APC gene pathogenic variants have a high penetrance with a theoretical risk to develop colorectal cancer in 100% of patients. Because the risk of cancer rises dramatically in the third decade of life, guidelines consider a prophylactic surgery in second decade.

Methods

Descriptive analysis of a series of adolescent patients with familial polyposis operated, from the hereditary polyposis registry database prospectively maintained. Adolescent patients older than 14 years with pathogenic mutation in the APC gene and evidence of colorectal adenomas were considered for prophylactic surgery. Only for unfavorable histology or major symptoms surgery was anticipated. Indications for total colectomy with ileo-rectal anastomosis (TC/IRA) included less than 30 polyps inferior than 1 cm diameter in the rectum evidenced via colonoscopic pre-surgical examination.

Results

Between February 2005 and September 2016, 33 adolescent patients with classic FAP underwent laparoscopic prophylactic surgery. APC gene pathogenic variant have been detected in all patients and in 3 pts (9%) of them a mutation was detected in codon 1309, 8/33 patients (24%) were proband. Of the 33 patients, 18M and 15F, median age 16 yo (range 7-19), median BMI 21 (range 15-32). 29/33 patients (87%) received a TC/IRA and 4 patients a proctocolectomy with ileo-pouch-anal anastomosis (PC/IPAA). No patients have been converted to open surgery. Median surgical time was: TC/IRA 300min (210-420), PC/IPAA 400min (360-480). Median postoperative stay was 5 days (4-24). Early postoperative complication: 1 abdominal bleeding (3%), 1 dural puncture (3%), 3 anastomotic leakage (9%) 1TC/IRA and 2 PC/IPAA. Pathological reports showed high-grade dysplasia in 7 patients (21.2%), while no cancer have been detected. During a median follow-up of 59 months (4-134) no patients died or had a second abdominal surgery because of cancer in rectal stump. One male patient (3%) showed an abdominal wall desmoid and 1 patient (3%) had a small bowel obstruction.

Conclusions

The rectal sparing surgery was the first choice in the major respect of quality of life. 100% of adolescent patients were promptly operated before the development of cancer in colonic adenomas. Laparoscopic prophylactic surgery for familial polyposis, well accepted from adolescents, is a safe option also confirmed by the low incidence of post-surgical desmoid and a quick post-operative recovery.

OC120 - ANALYSIS OF THE EFFECT OF SINGLE NUCLEOTIDE POLYMORPHISMS ON AGE OF ONSET OF COLORECTAL CANCER IN PATIENTS WITH LYNCH SYNDROME (HEREDITARY NON-POLYPOSIS COLORECTAL CANCER)

L. Pearce¹, K. Bean¹, S. Pervez¹, A. Wallace¹, J. Hill¹, G. Evans¹

¹*Central Manchester NHS Foundation Trust Manchester*

Background

Lynch Syndrome (LS) is an inherited cancer predisposition syndrome. Patients develop colorectal cancer at a young age but age of onset of disease can be wide ranging. Single nucleotide polymorphisms (SNPs) have been shown to predict age of onset of malignancy in patients with high-risk mutations for breast cancer. The ability to predict risk of age of onset of disease in patients with Lynch Syndrome could potentially reduce the repeated risk exposure and inconvenience that comes with screening colonoscopy, potentially improving compliance with current screening regimes and targeting prophylactic surgery to individual patients where appropriate.

Methods

MLH1 and MSH2 mutation carriers, patients with sporadic colorectal cancer but no genetic mutation and a control population were identified from the Manchester Genetics Database. A SNP panel of 16 SNPs previously identified in validation studies to be associated with colorectal cancer was developed. Lymphocyte DNA was sequenced and genotyped using Sequenom MassArray technology. Polygenic risk scores for each individual were stratified into quintiles. Cox proportional hazards model was used to assess the relationship between colorectal cancer and risk score. Polygenic risk scores (overall colorectal cancer risk scores (OCRS)) were calculated for each patient depending on the number of risk alleles and minor allele frequencies (MAF) described in published validation studies. Weighted risk scores were then calculated for each SNP, for the presence of zero, one or two risk alleles (wild type, heterozygous, homozygous respectively). Relative risks published in validation studies were utilised such that the weighting for each genotype when multiplied by the population frequencies of the genotypes equals 100. As such, the odds ratios were normalized around a population average risk of 1.0.

Results

943 patients were included in the analysis (162 MLH1, 207 MSH2 mutation carriers, 251 sporadic colorectal cancer cases, and 323 controls). 67.1% MLH1 and 47.8% of MSH2 mutation carriers had developed colorectal cancer. Overall colorectal cancer risk score (OCRS) was higher in the sporadic group than any other group (MLH1 $p=0.02$, MSH2 $p<0.001$, Control $p<0.001$). There was no association with increasing OCRS and earlier age of onset of disease in MLH1, MSH2 or sporadic groups ($p>0.05$).

Conclusion

This study confirms that SNPs previously reported to be associated with colorectal cancer are more prevalent in patients with sporadic colorectal cancer than in high-risk mutation carriers or a control population. These SNPs do not appear to have current value in predicting age of onset of disease in any of the populations included in the study.











OC122 - GASTRIC CANCER IN FAP: A CONCERNING RISE IN INCIDENCE

C. A. Burke¹, G. Mankaney², M. Cruise³, L. Laguardia¹, P. Leone⁴, M. O' Malley¹, A. Bhatt¹, J. Church¹

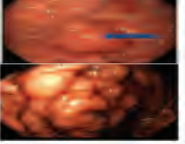
¹Sanford R. Weiss MD Center for Hereditary Colorectal Neoplasia, Cleveland Clinic Cleveland, ²Gastroenterology and Hepatology, Cleveland Clinic Cleveland, ³Pathology and Laboratory Medicine, Cleveland Clinic Cleveland, ⁴Internal Medicine, Cleveland Clinic Cleveland

Introduction: Gastric cancer (GC) is not a cited cancer risk in Western FAP patients. We observed a rapid rise in GC in our patients followed in an EGD surveillance program. We analyzed the incidence and describe the endoscopic features of GC in our patients. **Methods:** 767 FAP patients with > 1 EGD performed between 1/2001-11/2016 were identified through the David G. Jagelman Inherited Colorectal Cancer Registries Cologene™ database. EGDs were performed prospectively with random gastric polyp biopsy and targeted resection of polyps > 9 mm or of unusual appearance. The age adjusted standardized incidence ratio (SIR) of GC was calculated. **Results:** 10/767 (1.3 %) patients developed GC for a SIR of 140. No GC was diagnosed from 1979 until 2006 when the first case occurred then 9 cases occurred between 2012-2016. The mean age at GC diagnosis was 57 years (range 35–75) (Table 1). 8 patients were asymptomatic including 4 with stage I GC. 6 were diagnosed with stage IV GC. 3 patients had duodenectomy prior to GC diagnosis: 2 with stage I GC (ampullary cancer 15 years prior and stage IV duodenal polyposis 10 years prior) and 1 with stage IV GC (stage IV duodenal polyposis 15 years prior) . All stage I patients underwent gastrectomy and 1 died of post-op complications, 3 are alive at 6,8 and 9 months after surgery. 4/6 patients with metastatic GC died within a mean 4.5 months. The duration of EGD surveillance was 10.9 years (range 4-20), average of 9.7 EGDs (range 2-17), and a mean interval between EGDs of 1.8 years (range 0.5-4 years) (Table 2). All cancer occurred in the proximal stomach in patients with a carpeting of proximal polyposis. 9 patients had a carpeting of FGPs on 1st EGD with the largest polyp < 1cm. In all cases, polyp size increased with development of large mounds of proximal polyposis within 1-2 years of cancer diagnosis. 6 patients had GC diagnosed on targeted snare resection of polyps > 1cm or mounds of polyposis, 1 on random gastric polyp biopsy. 1 cancer was diagnosed by EUS FNA of a hypoechoic lesion 4 cm beneath a layer of FGPs. Biopsies of the overlying mucosa revealed FGP with low grade dysplasia. **Conclusions:** GC is a rising risk in Western FAP patients. in patients with a carpeting of proximal polyposis, particularly with the development of large mounds within the polyposis we recommend frequent EGD surveillance and aggressive resection of large lesions with consideration of EUS in select cases.



Table 1. Gastric findings on EGD and polyp pathology over the surveillance period

Patient	Baseline EGD	Interval Surveillance EGDs	Endoscopic Findings at Diagnosis	EGD Image at Diagnosis	Adenocarcinoma Staging (method)	Survival after Dx
1	Number: Carpeting Size: 5-10mm Location: C,F,B Path: FGP-LGD	Number: Carpeting Size: 5-15mm Location: C,F,B Path: FGP-LGD	Number: Carpeting Size: 4 to > 50mm Location: C,F,B Path: FGP-HGD, TA-HGD Cancer: intramucosal		Stage IV (metastatic on ex-lap)	Deceased – 5 months
2	Number: Carpeting Size: 2-10 mm Location: C,F,B Path: FGP-ND, TA-LGD	Number: Carpeting Size: 5-25 mm Location: C,F,B Path: PGA, TA-LGD, FGP-LGD	Number: Carpeting Size: 2-20 mm Location: C,F,B Path: FGP-HGD Cancer: intramucosal		Stage IV (liver mets on biopsy)	Alive - 19 months - on chemotherapy with no evidence of disease on surveillance EGD.
3	Number: Carpeting Size: 5-10mm Location: F,B Path: FGP-ND, TA	Number: Carpeting Size: 5-10mm Location: F,B Path: FGP-ND, TVA-LGD	Number: Carpeting Size: 3-30mm Location: C,F,B Path: FGP-HGD Cancer: invasive		Stage IV (liver metastasis on CT)	Deceased - 2 months
4	Number: Carpeting Size: 5-10mm Location: C,F,B Path: FGP-LGD	N/A (only two EGDs)	Number: Carpeting Size: largest >10mm Location: C,F,B Path: FGP-LGD Cancer: none found	None Available	Stage IV (peritoneal carcinomatosis on laparoscopy)	Deceased – 1 month
5	Number: Carpeting Size: <5mm Location: C,F,B Path: FGP-ND	Number: Carpeting Size: <5mm Location: C,F,B Path: FGP-HGD, PGA-HGD	Number: Carpeting Size: Up to 25 mm Location: C,F,B Path: FGD Cancer: invasive		Stage IB (T2NoMo on gastrectomy)	Deceased – 3 months (within 3 weeks of gastrectomy from postoperative complications)
6	Number: Carpeting Size: <5mm Location: B Path: FGP-ND	Number: Carpeting Size: 3-50mm Location: F,B Path: PGA-HGD, FGP-HGD	Number: Carpeting Size: 3-50mm Location: F, B Path: FGP-HGD, PGA-HGD, TA-HGD Cancer: invasive		Stage IV (liver metastasis on PET)	Deceased – 10 months.
7	Number: Carpeting Size: <5mm Location: F Path: FGP-LGD	Number: Carpeting Size: <5mm Location: C,F,B Path: FGP-LGD	Number: Carpeting Size: 3- >50mm Location: C, F, B Path: FGP-LGD, PGA-HGD Cancer: intramucosal		Stage IA (EGD)	Alive – 9 months. Status post curative total gastrectomy
8	Number: Carpeting Size: 2-10mm Location: C,F,B Path: FGP-ND, TA-LGD	Number: Carpeting Size: 2-50mm Location: C,F,B Path: FGP-LGD, TA-LGD	Number: Carpeting Size: 2-50mm Location: C,F,B Path: Hyperplastic polyp, FGP-LGD, TA-LGD Cancer: none found	 	Stage IA (EUS-FNA positive for adenocarcinoma, gastrectomy specimen)	Alive – 8 months. Status post curative total gastrectomy
9	Number: Carpeting Size: 3 x >1cm Location: C,F,B Path: FGP-LGD	Number: Carpeting Size: 2-50mm Location: C,F,B Path: FGP-HGD, TA-HGD	Number: Carpeting Size: 3-50mm Location: C,F,B Path: FGP-HGD, multifocal TA-HGD		Stage Ia (gastrectomy specimen)	Gastrectomy – 6 months.
10	Number: Carpeting Size: <8mm Location: C,F,B Path: FGPLGD	Number: Carpeting Size: 2mm-2cm Location: C,F,B Path: PGA-LGD, FGP-LGD	Number: Carpeting Size: 3-30mm mounds Location: C,F,B Path: PGA-LGD, FGP-LGD Cancer: invasive	 	Stage IV (liver metastasis on CT)	Alive – 2 month. Started chemotherapy.

Key: FGP – fundic gland polyp, TA-tubular adenoma; PGA-pyloric gland adenoma, LGD-low grade dysplasia, HGD-high grade dysplasia, ND– no dysplasia

C= cardia, F= fundus, B= body of stomach, ND= no dysplasia, LGD= low grade dysplasia, HGD= high grade dysplasia

Table 2. Clinical and endoscopic features of FAP patients with gastric cancer

Patient	Age / Year Diagnosis	Mutation	Total Surveillance Period (years)	# of EGDs	Months between 1st EGD with polyps <=10mm & last EGD with polyps <10mm	Months between last EGD with polyps <=10mm & 1 st with polyps >10mm	Months between 1st EGD with polyps >10mm & Ca Dx	Illustration of baseline EGD with fundic gland polyposis
1	65 / 2015	3202del4	12.5	7	96	36	18	
2	36 / 2015	3182del5	10.1	9	98	7	17	
3	64 / 2014	4350delA	10.6	15	120	8	0	
4	43 / 2006	4733_4734delG	4	2	—	48	0	Illustration of size progression in polyposis
5	56 / 2012	None found	11.25	11	108	17	10	
6	57 / 2016	Q1328X	20	15	171	14	55	
7	62 / 2016	1495C>T	10.6	5	59	30	45	
8	60 / 2016	453delA	9.5	9	65	12	62	
9	55 / 2016	None found	8.5	6	0	0	0	
10	75 / 2016	None found	17.8	12	171	38	46	

OC123 - FAMILIAL GASTRIC CANCER & NEXT-GENERATION SEQUENCING: RESULTS FROM A PANEL OF 94 GENES IN AN ITALIAN CASE SERIES.

G. Tedaldi¹, V. Zampiga¹, M. Tebaldi¹, R. Danesi², V. Arcangeli³, M. Ravegnani², I. Cangini¹, F. Pirini¹, G. N. Ranzani⁴, R. Abou Khouzam⁴, F. Falcini², D. Amadori⁵, D. Calistri¹

¹Biosciences Laboratory, Istituto Scientifico Romagnolo per lo Studio e la Cura dei Tumori (IRST) IRCCS Meldola (FC) - Italy,

²Romagna Cancer Registry, Istituto Scientifico Romagnolo per lo Studio e la Cura dei Tumori (IRST) IRCCS Meldola (FC) - Italy,

³Department of Medical Oncology, Ospedale Infermi Rimini (RN) - Italy, ⁴Department of Biology and Biotechnology, University of

Pavia Pavia (PV) - Italy, ⁵Department of Medical Oncology, Istituto Scientifico Romagnolo per lo Studio e la Cura dei Tumori (IRST) IRCCS Meldola (FC) - Italy

Background and aim

The major gene involved in gastric cancer (GC) predisposition is *CDH1*, but other genes have recently emerged as possibly predisposing to the disease.

The aim of our study was to assess the presence of predisposing mutations in Italian patients with GC family history by analyzing a panel of 94 genes involved in different carcinogenic processes and in the main cancer syndromes.

Patients and methods

We selected 63 patients with GC and 13 patients with lobular breast cancer showing strong family history of GC. Genomic DNA was extracted from peripheral blood samples and analyzed by Next-Generation Sequencing, using an enrichment protocol (Illumina Trusight Cancer) on MiSeq platform. Results were analyzed by a customized bioinformatic pipeline.

Results

In 7 out of 76 patients (9.2%), we identified 7 *CDH1* pathogenic mutations: 3 frameshift deletions, 3 nonsense mutations and 1 gross deletion. Three out of 7 identified mutations had previously been reported, while 4 were novel.

In 9 out of 76 patients (11.8%), we found 9 functional mutations in unexpected genes, including *ATM*, *BLM*, *BMPRIA*, *BRCA1*, *BRCA2*, *PALB2*, *PMS2* and *PRF1*. Four out of 9 mutations were frameshift deletions and 5 were nonsense mutations.

In 60 out of 76 cases (78.9%) we did not find any clear functional mutation. By taking into account all the identified variants, the 60 patients showed 271 variants with a population frequency <1% or n/a in the 1000Genomes, Esp6500, and Exac03 databases: 93 were synonymous variants, 173 were missense mutations, 3 were in-frame deletions and 2 in-frame insertions. A total of 244 variants in 76 different genes were unique.

To assess their possible role in cancer development, we evaluated the 156 unique missense variants by using PolyPhen-2 HVar/SIFT bioinformatics tools: 66 variants were classified as benign by both tools, 63 were discordantly classified and 27 were classified as probably damaging by both tools.

Conclusions

Some of the new functional mutations identified were in genes related to breast cancer (*BRCA1*, *BRCA2*, *ATM* and *PALB2*) or to colorectal cancer (*BMPRIA* and *PMS2*), while others were in genes involved in susceptibility to multiple cancers, mainly leukemias and lymphomas (*BLM* and *PRF1*). Further studies based on segregation analysis within pedigrees and on functional assays in vitro, will definitely confirm the role of these mutations in GC development. These studies will also contribute to select pathogenic mutations among the 27 variants classified as probably damaging by bioinformatic tools.

OC126 - TOWARDS EARLY DETECTION OF PANCREATIC CANCER: APPLYING NGS IN THE CLINICAL SETUP

G. Rosner¹, E. Scapa¹, M. Ben-Yehoyada¹, R. Kariv¹

¹Department of Gastroenterology and Liver Diseases, Tel-Aviv Sourasky Medical Center, Sackler School of Medicine, Tel-Aviv University, Tel-Aviv, Israel Tel-Aviv

Background: Pancreatic cancer (PC) It is the third leading cause of cancer death in the US, with a lifetime risk of 1.5%. The 5-year survival rate is 7.2%, the poorest survival rate of any common malignancy. PC development from a small precancerous lesion into a tumor is a relatively slow process, emphasizing the importance of screening in high-risk individuals.

Aims: The concept of a dedicated high-risk pancreatic cancer clinic is relatively new and there are only a few such clinics worldwide. We established a high-risk pancreatic cancer clinic with the aims of: improving survival of individuals at high-risk for pancreatic cancer and identifying genetic alterations and molecular pathways associated with familial pancreatic cancer risk.

Materials and methods: We have recruited 135 high-risk PC individuals for genetic screening and clinical surveillance. Forty individuals fulfilled criteria for familial pancreatic cancer and 70% of the cohort have undergone genetic testing.

Results: 40 individuals (45% of those who were tested) were found to carry a pathogenic mutation. BRCA2 mutation was found most frequently (20%), followed by BRCA1 (14%), PALB2, STK11 and ATM mutations. Whole exome sequencing (WES) revealed a wide variety of genetic changes (KLLN, HMMR, GATA5, MSR1 and KDR genes), that would not have been detected, if testing was limited to multi-gene panels.

Conclusions: Identifying high-risk pancreatic cancer individuals is crucial for surveillance and improved survival. WES is the test of choice for genetic evaluation of these high-risk individuals

OC133 - ROUTINE MOLECULAR ANALYSIS FOR LYNCH SYNDROME IN PATIENTS WITH ADVANCED ADENOMA OR COLORECTAL CANCER WITHIN A NATIONAL SCREENING PROGRAM FOR COLORECTAL CANCER.

A. Goverde¹, W. N. Dinjens², M. J. Bruno³, R. M. Hofstra⁴, M. Doukas², M. M. Van der Weiden², E. J. Dubbink², A. Wagner⁴, M. C. Spaander³

¹Clinical Genetics / Gastroenterology & Hepatology, Erasmus MC Rotterdam, ²Pathology, Erasmus MC Rotterdam,

³Gastroenterology & Hepatology, Erasmus MC Rotterdam, ⁴Clinical Genetics, Erasmus MC Rotterdam

Background Screening for Lynch syndrome (LS) by immunohistochemical staining (IHC) in colorectal cancer (CRC) patients ≤ 70 years of age is recommended. LS screening in adenoma patients could yield more benefit, since CRC can still be prevented in these patients. We aimed to assess the diagnostic yield of IHC for LS in patients with advanced and multiple adenomas or CRC within the Dutch national CRC screening program.

Methods We included participants of the national CRC screening program, referred for colonoscopy from December 2013 onwards. IHC was performed on advanced adenomas and CRCs found at colonoscopy. Adenomas were considered advanced if they had a villous component, high-grade dysplasia or were ≥ 10 mm in size. Also, in cases with ≥ 4 non-advanced adenomas, IHC was performed on the largest adenoma. *MLH1* hypermethylation analysis was used to distinguish sporadic *MLH1* deficiency from *MLH1* deficiency suspect for LS. Patients with IHC suspect for LS were offered germline mutation analysis. If no pathogenic mutation was found, we performed somatic mutation analysis.

Results A total of 913 patients (53% male; mean age of 66 years (± 6 years)) with positive FIT were included. At colonoscopy, 345 (38%) patients (63% male; mean age of 67 years (± 6 years)) had a CRC and/or adenoma eligible for IHC. A total of 316 adenoma patients were analyzed. None had aberrant IHC. Of the examined adenomas, 148 (47%) had a villous component and/or high grade dysplasia (128 (41%) with villous component and 37 (12%) with high grade dysplasia). Out of 44 CRC patients, 6 (15%) showed loss of protein expression. All six cases had loss of *MLH1* and *PMS2* protein. Four cases had *MLH1* promoter hypermethylation. The patients without *MLH1* promoter hypermethylation were referred for genetic counselling. Both patients had no family history suspect for LS and no germline *MLH1* mutation was found. However, two somatic *MLH1* mutations were found in the tumor of the first patient and a somatic *MLH1* mutation and loss of heterozygosity were found in the tumor of the second patient.

Conclusion Our results indicate that routine LS screening by IHC in patients with advanced and multiple adenoma within a national FIT-based screening CRC program is not an effective strategy. The diagnostic yield of LS screening in younger adenoma patients should be assessed. Also, our results imply that *MLH1* promoter hypermethylation may be a late event in oncogenesis, since none of the adenomas had aberrant IHC.

OC133 - THE SPECTRUM OF GASTRIC POLYP PATHOLOGY IN WESTERN PATIENTS WITH FAP- RELATED GASTRIC CANCER: CLUES TO CANCER ORIGIN

C. A. Burke¹, R. Jawale², G. Mankaney³, P. Leone⁴, L. LaGuardia¹, M. O'Malley¹, J. Church¹, D. Patil², S. Robertson², M. Cruise²
¹Sanford R. Weiss MD Center for Hereditary Colorectal Neoplasia, Cleveland Clinic Cleveland, ²Pathology and Laboratory Medicine, Cleveland Clinic Cleveland, ³Gastroenterology and Hepatology, Cleveland Clinic Cleveland, ⁴Internal Medicine, Cleveland Clinic Cleveland

Background: Gastric carcinomas (GC) are rarely reported in Western patients with familial adenomatous polyposis (FAP) and there are no specific surveillance recommendations for FAP related GC. We recently observed an increase in the incidence of GC in our FAP patients and describe the gastric pathology from these cases. Design: We performed clinicopathologic assessment of FAP related gastric polyps (GP) and GC in all FAP patient with GC at a single-center with an inherited colorectal cancer registry (n=767). GPs and GCs from FAP patients were reviewed by gastrointestinal pathologists for subtype, dysplasia, and associated histological features. Results: 10 cases of GC were identified. All occurred in the upper stomach in patients with a carpeting of proximal polyposis. 161 gastric polyps from 10 patients were evaluated. There were 85 fundic gland polyps (FGP), 32 pyloric gland adenomas (PGA), 7 gastric adenoma-intestinal type (GA-IT), 29 gastric adenoma-foveolar type (GA-FT) and 8 mixed polyps (MP) (n=8). 48 (56%) of FGP were without dysplasia. 37/85 FGPs had low grade dysplasia (LGD) and none had high grade dysplasia (HGD) in a pure form. 22/32 (69%) of PGAs had HGD, 7/22 (32%) PGA with HGD had an adenocarcinoma. All 7 GA-IT had LGD. 21/29(72%) GA-FT had LGD, 8/29 had HGD and 1 was with adenocarcinoma. MPs (n=8) all demonstrated HGD with 3/8 demonstrated squamoid/neuroendocrine phenotype and were associated with adenocarcinoma. Interestingly, 2 PGA, HGD had traditional serrated adenoma features and 3 PGA, HGD had a dense lymphoid stroma. 13/161 GPs (8%) had adenocarcinoma (IMC or invasive) with 3 patients having multiple tumors. 7/13 (54%) arose in a background of pure PGA with HGD and 1 in GA-FT with HGD. 5 adenocarcinomas arose in MPs, and 4 of these polyps had PGA with HGD (80%) and 3 with squamoid/neuroendocrine phenotype (60%). Conclusions: FAP patients harbor a spectrum of polyps including FGP, PGA, GA-IT and GA-FT and MP. MP and PGA with HGD appear to have the greatest association with GC in FAP patients. A squamoid/neuroendocrine phenotype can be associated with MPs and co-exist with GC. GC should be considered a cancer risk in Western patients with FAP. Widespread random and targeted sampling of proximal polyposis in patients with a carpeting of gastric polyps may enhance the detection of PGAs or MPs. FAP patients with PGAs and MPs appear to be a high GC risk group and may warrant aggressive surveillance and early surgical intervention.

OC138 - OHIO COLORECTAL CANCER PREVENTION INITIATIVE

R. Pearlman¹, H. Hampel¹, A. de la Chapelle², R. Goldberg³, K. Ciombor⁴, M. Arnold⁵, I. Lattimer¹, W. Frankel⁶, W. Zhao⁶, D. Jones⁶, A. Yilmaz⁶, C. Pritchard⁷, M. Kalady⁸, B. Heald⁸

¹Ohio State University Comprehensive Cancer Center, Internal Medicine Columbus, ²Ohio State University Wexner Medical Center, Cancer Biology and Genetics Columbus, ³West Virginia University, Medicine Morgantown, ⁴Ohio State University Comprehensive Cancer Center, Medical Oncology Columbus, ⁵Ohio State University Wexner Medical Center, Surgery Columbus, ⁶Ohio State University Wexner Medical Center, Pathology Columbus, ⁷University of Washington, Laboratory Medicine Seattle, ⁸Cleveland Clinic, Colorectal Surgery Cleveland

Background: The prevalence of pathogenic germline mutations in hereditary cancer predisposition genes among colorectal cancer (CRC) patients was investigated using multi-gene panel testing (MGPT).

Methods: Patients were accrued at 51 hospitals in Ohio from 1/1/13-12/31/16. All had tumor screening for Lynch syndrome (LS) including microsatellite instability and/or immunohistochemical analysis of the mismatch repair (MMR) proteins, and *MLH1* methylation testing if abnormal. All patients with MMR deficiency (dMMR) without methylation (Cohort A) had MGPT. If a germline MMR gene mutation was not found, tumor DNA was tested for somatic mutations. Patients with dMMR due to methylation and those with MMR proficiency (pMMR) who were diagnosed <50, had a close relative with CRC or endometrial cancer, or had multiple primary tumors (Cohort B) had MGPT.

Results: Of 2510 patients with testing complete, 385 (15.3%) were dMMR, 2125 (84.7%) were pMMR, 96 (3.8%) had LS, 74 (2.9%) had a different hereditary cancer syndrome, seven had two syndromes. Of the 385 patients with dMMR, 243 (63.1%) had methylation (including two with constitutional methylation). Of the 142 patients with dMMR without methylation, 96 individuals had 100 mutations including 90 LS (19 *MLH1*, 43 *MSH2*, 14 *MSH6*, 15 *PMS2*, 1 *EPCAM*) and 10 other syndromes (2 biallelic *MUTYH*, 4 monoallelic *MUTYH*, 1 *GALNT12*, 1 *RAD51D*, 1 *RPS20*, 1 *APC* I1307K). Fifty-two patients had unexplained dMMR and 47 underwent tumor sequencing; 43 had somatic mutations in a MMR gene (including five with a different hereditary cancer syndrome), four remained unexplained dMMR (including the one with *APC* I1308K). Of the 924 patients in Cohort B, 65 individuals had 68 mutations including four LS (1 *MSH6*, 3 *PMS2*), 38 mutations in genes associated with CRC (9 *APC*, 5 *APC* I1307K, 5 biallelic *MUTYH*, 18 monoallelic *MUTYH*, 1 *SMAD4*) and 26 mutations in genes not traditionally associated with CRC (5 *BRCA2*, 2 *BRCA1*, 7 *ATM*, 3 *BRIP1*, 4 *CHEK2*, 3 *PALB2*, 2 *CDKN2A*).

Conclusion: 170 pathogenic germline mutations were found in 163 individuals from 2510 CRC patients (6.5%). LS was more common (96/2510; 3.8%) than previously reported. Three percent (74/2510) of patients had a different hereditary cancer syndrome, emphasizing the importance of MGPT that includes genes not traditionally associated with CRC. Academic centers can help community hospitals implement hereditary cancer screening through large scale collaborations.

OC141 - GASTRIC PATHOLOGY IN CDH1 MUTATION CARRIERS WITH AND WITHOUT FAMILY HISTORY OF GASTRIC CANCER : IMPLICATIONS FOR CLINICAL MANAGEMENT

E. Stoffel¹, M. Jacobs¹, E. Koeppel¹, K. Hanson¹, J. Osborne¹, M. Marvin¹, J. Everett¹, K. Choi¹, S. Wong², H. Appelman³
¹University of Michigan Ann Arbor, MI USA, ²Dartmouth Medical School Hanover, NH USA, ³Un Ann Arbor, MI USA

~Background: Germline mutations in CDH1 are implicated in hereditary diffuse gastric cancer (HDGC), with reported lifetime gastric cancer risks of 60-80%. The recent increase in use of multigene panels in clinical cancer genetic testing has resulted in unexpected findings of germline CDH1 mutations in families who do not meet clinical criteria for HDGC. Whether risk for DGC in CDH1 mutation carriers without family history of gastric cancer is high enough to warrant total prophylactic gastrectomy is not known.

Methods: We reviewed medical records, pedigrees, endoscopy reports, and pathology reports of patients diagnosed with pathogenic germline CDH1 mutations evaluated at the University of Michigan Cancer Genetics Clinic between 1998 and 2016. We compared clinical outcomes of subjects who did and did not meet clinical criteria for HDGC (defined as two gastric cancer (GC) cases in a family with one diagnosed age<50, or three relatives with DGC, or DGC age< 40 years, or personal/family history of DGC and lobular breast cancer, with one diagnosed age <50).

Results: 21 mutation carriers from 12 families were identified. Only 5 of the 12 families (42%) met clinical criteria for HDGC and 5 were identified through multigene panel tests ordered on the basis of personal/family history of breast cancer. 13 CDH1 carriers underwent screening upper endoscopies with >40 random mucosal biopsies. All had endoscopically normal-appearing gastric mucosa; however 5 had abnormal histology on biopsies. 9 subjects (3 with abnormal and 6 with normal biopsies) underwent total gastrectomy. In-situ multifocal signet ring cell gastric cancer was confirmed in gastrectomy specimens of 6 subjects (3 had normal endoscopic biopsies). Of the 9 CDH1 carriers who did not meet clinical criteria for HDGC who underwent endoscopic screening, 5 (56%) had signet ring cells identified on endoscopic biopsies and/or gastrectomy specimens.

Conclusion: The prevalence of germline CDH1 mutations appears to be higher than previously appreciated and many carriers do not meet clinical criteria for HDGC. Normal endoscopic biopsies do not exclude DGC and prophylactic gastrectomy should be considered for CDH1 mutation carriers even in the absence of a FH of gastric cancer

OC148 - HEALTH4FAMILIES: A BEHAVIORAL INTERVENTION TO IMPROVE WEIGHT AND HEALTH BEHAVIORS IN LYNCH SYNDROME FAMILIES

K. Basen-Engquist¹, L. Strong², S. Schembre¹, M. Cox-Martin¹, L. Li³, C. Karam¹, J. Song³, M. Pande⁴, Y. N. You⁵, M. Rodriguez-Bigas⁵, P. Lynch⁶, S. K. Peterson¹

¹MD Anderson Cancer Center, Behavioral Science Houston, TX USA, ²MD Anderson Cancer Center, Health Disparities Research Houston, TX USA, ³MD Anderson Cancer Center, Biostatistics Houston, TX USA, ⁴MD Anderson Cancer Center, Gastroenterology research Houston, TX USA, ⁵MD Anderson Cancer Center, Surgical Oncology Houston, TX USA, ⁶MD Anderson Cancer Center, Gastroenterology, Hepatology, & Nutrition Houston, TX USA

Background: Early data indicate that lifestyle behaviors such as physical activity, diet, and weight management may reduce the risk of Lynch syndrome cancers, but there are no evidence-based programs to help Lynch syndrome families make these behavioral changes. This study evaluated baseline data from a 16-week family-centered intervention trial to improved weight management and physical activity for individuals with Lynch syndrome mutations and their family members.

Methods: Index cases (with or without a personal cancer history) with Lynch syndrome-associated gene mutations were recruited through an advertisement posted on the *Lynch Syndrome International* Facebook page. Eligible index cases also identified family members to participate in a 16-week diet, physical activity, and weight management program, comprising activity monitoring using Fitbits, text-messaging, dietary monitoring, and coaching. Questionnaires to measure demographic, medical, and behavior data were administered online.

Results: Within 48 hours of the Facebook post, 126 Lynch syndrome-affected individuals expressed interest in the study. Of these, 35 index cases (14 with a cancer history) were enrolled in the first wave of our study plus 36 family members (18 had tested positive for a Lynch syndrome mutation, 24 had a cancer history). Sixty-nine index cases are on a waiting list. Participants were predominantly female (84%) and non-Hispanic white (94%). The mean age was 46.7 (SD=12.5), and 42% had at least a 4-year college degree. Baseline BMI was in the high overweight range (M=29.5, SD=6.3), and on average participants reported 94.1 minutes (SD=107.1) of moderate to vigorous physical activity and 47 hours (SD=28.1) of sedentary behavior per week. Index participants were more likely to be female than family members (p=.0065) but there were no other demographic or behavioral differences between the two groups. Participants reported being in a more advanced stage of readiness to address weight control (82% in action or maintenance stage) than physical activity (35% in action or maintenance).

Conclusions: Baseline data indicate that individuals with Lynch syndrome and their family members are highly interested in diet, physical activity, and weight management interventions, and have a high need due to overweight and low levels of physical activity. Lifestyle interventions that implement distance-based methods to improve weight management and physical activity may be ideally suited for Lynch syndrome families, who are at increased cancer risk but who are often geographically dispersed.

OC150 - FACTORS ASSOCIATED WITH THE DEVELOPMENT OF GASTRIC CANCER IN FAP

P. Leone MD, MPH¹, G. Mankaney, MD², S. Abushamma MD¹, R. Lopez MS³, J. Church MD⁴, M. Cruise MD, PhD⁵, L. LaGuardia BSN⁴, M. O'Malley MS⁴, C. Burke MD⁶

¹Internal Medicine, Cleveland Clinic Cleveland, Ohio, USA, ²Gastroenterology and Hepatology, Cleveland Clinic Cleveland, Ohio, USA,

³Quantitative Health Sciences, Cleveland Clinic Cleveland, Ohio, USA, ⁴Sanford R. Weiss MD Center for Hereditary Colorectal

Neoplasia, Colorectal Surgery, Cleveland Clinic Cleveland, Ohio, USA, ⁵Pathology and Laboratory Medicine, Cleveland Clinic

Cleveland, Ohio, USA, ⁶Sanford R. Weiss MD Center for Hereditary Colorectal Neoplasia, Gastroenterology and Hepatology,

Colorectal Surgery, Cleveland Clinic Cleveland, Ohio, USA

Introduction: We observe a rapid increased in the incidence of gastric cancer (GC) in our FAP patients followed in an endoscopic surveillance program. We performed a case control study to determine clinical and endoscopic factors associated with GC in FAP. **Methods:** FAP patients were identified through the IRB approved David G. Jagelman Inherited Colorectal Cancer Registries Cologene™ database. All FAP patients with GC and randomly selected FAP patients without GC with >2 EGDs were analyzed. Demographic, clinical, endoscopic and pathologic features were compared. A $p < 0.05$ was considered statistically significant. **Results:** 10 patients developed GC. Age at diagnosis of FAP and at last EGD or diagnosis of GC, race, gender, BMI, tobacco exposure, personal history of cancer (CRC, thyroid, duodenal), family history of CRC, and history of duodenal surgery were not different between cases and controls (Table 1). Patients with GC were more likely than controls to have desmoids (60% vs 16%, $p < 0.001$), PPI (90% vs 54%, $p = 0.029$) and H2RA exposure (60% vs 13%, $p < 0.001$), a longer length of EGD surveillance (10.8 vs 6 years, $p < 0.002$) but similar intervals between EGDs (1.3 vs 2.3 years, $p = 0.21$) (Table 2). Endoscopic features significantly associated with GC include a carpeting of proximal polyposis (100% vs 26%, $p < 0.001$), greater numbers and largest sizes of solitary proximal polyps and the presence of a polypoid mound within proximal polyposis (all $p < 0.001$) (Table 2). The pathology of proximal polyps varied significantly between GC and controls including the presence of intestinal metaplasia (30% vs 2.9%, $p = 0.013$), fundic gland polyps with low grade (100% vs 54%, $p = 0.006$) and high grade dysplasia (HGD) (40% vs 7%, $p = 0.002$), tubular adenomas (30% vs 6%, $p = 0.01$) and pyloric gland adenomas with HGD (20% vs 0%, $p = 0.014$) (Table 3). **Conclusions:** Endoscopic features associated with GC in FAP include a carpeting of proximal gastric polyposis, with large size of single polyps, and polypoid mound of polyposis. Intestinal metaplasia and polyps with advanced pathology are frequently seen in patients who develop gastric cancer. These features signal a patient warranting closer EGD surveillance.

Table 1. Demographics and Medical History

Factor	Overall (N=80)		No GC (N=70)		GC (N=10)		p-value
	N	Statistics	n	Statistics	n	Statistics	
Age at last EGD/GC	77	49.4±15.5	67	48.3±15.8	10	56.7±11.5	0.11 ^a
Gender	80		70		10		0.93 ^c
Male		33(41.3)		29(41.4)		4(40.0)	
Female		47(58.8)		41(58.6)		6(60.0)	
Race	80		70		10		0.99 ^d
Black/African American		1(1.3)		1(1.4)		0(0.0)	
White		77(96.3)		67(95.7)		10(100.0)	
Hispanic or Latino		2(2.5)		2(2.9)		0(0.0)	
White	80	77(96.3)	70	67(95.7)	10	10(100.0)	0.99 ^d
BMI	72	27.8±6.6	63	27.6±6.6	9	28.9±6.8	0.59 ^a
Tobacco Use	77	26(33.8)	67	22(32.8)	10	4(40.0)	0.65 ^c
Alcohol Use	77	37(48.1)	67	32(47.8)	10	5(50.0)	0.89 ^c
H. pylori status	56	1(1.8)	47	1(2.1)	9	0(0.0)	—
PPI Use	79	46(58.2)	69	37(53.6)	10	9(90.0)	0.029 ^c
H2 Blocker Use	79	15(19.0)	69	9(13.0)	10	6(60.0)	<0.001 ^c
ASA Use	79	10(12.7)	69	9(13.0)	10	1(10.0)	0.79 ^c
Statin Use	80	6(7.5)	70	6(8.6)	10	0(0.0)	0.34 ^c
Celecoxib Use	80	17(21.3)	70	11(15.7)	10	6(60.0)	0.001 ^c
Sulindac Use	79	24(30.4)	69	19(27.5)	10	5(50.0)	0.15 ^c
APC gene mutation	49	40(81.6)	42	34(81.0)	7	6(85.7)	0.76 ^c
Family History of FAP	79	56(70.9)	69	50(72.5)	10	6(60.0)	0.42 ^c
Family history of GC	79	2(2.5)	69	2(2.9)	10	0(0.0)	—
Family history of Colon Cancer	80	37(46.3)	70	33(47.1)	10	4(40.0)	0.67 ^c
Personal history of Colon Cancer	80	11(13.8)	70	11(15.7)	10	0(0.0)	0.18 ^c

Statistics presented as Mean ± SD or N (column %).

p-values: a=ANOVA, c=Pearson's chi-square test; d=Fisher's Exact test.

Table 2. EGD surveillance

Factor	Overall		No GC		GC		p-value
	N	Statistics	n	Statistics	n	Statistics	
Years between FAP dx and 1st EGD	74	16.5[6.0,27.0]	64	15.0[4.5,26.0]	10	26.0[21.0,34.0]	0.087 ^b
Observed avg. interval between EGDs (yrs)	80	1.9[1.1,2.9]	70	2.1[1.1,2.9]	10	1.3[1.2,1.9]	0.21 ^b
Num. of EGDs during FU	80	4.0[2.0,6.0]	70	4.0[2.0,5.0]	10	8.5[7.0,13.0]	<0.001 ^a
Follow-up (yrs) (1st EGD to last EGD/GC)	80	7.2[3.6,10.1]	70	6.0[3.1,9.7]	10	10.8[9.6,13.0]	0.002 ^b
Proximal polyposis	80	75(93.8)	70	65(92.9)	10	10(100.0)	0.99 ^d
Highest number proximal polyposis	75		65		10		<0.001 ^a
- 1-20		14(18.7)		14(21.5)		0(0.0)	
- 20-50		13(17.3)		13(20.0)		0(0.0)	
- 51-100		11(14.7)		11(16.9)		0(0.0)	
- > 100		10(13.3)		10(15.4)		0(0.0)	
- carpeting		27(36.0)		17(26.2)		10(100.0)	
Months to highest number proximal polyposis	75	12.3[0.00,63.8]	65	12.3[0.00,63.8]	10	18.8[0.00,47.7]	0.66 ^b
Smallest single proximal polyp	75		65		10		0.003 ^b
- 1-5 mm		62(82.7)		57(87.7)		5(50.0)	
- 6-10 mm		12(16.0)		8(12.3)		4(40.0)	
- 11-20 mm		1(1.3)		0(0.0)		1(10.0)	
Months to smallest single proximal polyp	75	0.00[0.00,0.00]	65	0.00[0.00,2.7]	10	0.00[0.00,0.00]	0.31 ^b
Largest single proximal polyp	75		65		10		<0.001 ^a
- 1-5 mm		24(32.0)		24(36.9)		0(0.0)	
- 6-10 mm		30(40.0)		30(46.2)		0(0.0)	
- 11-20 mm		11(14.7)		11(16.9)		0(0.0)	
- >20		10(13.3)		0(0.0)		10(100.0)	
Months to largest single proximal polyp	75	16.9[0.00,98.8]	65	8.2[0.00,54.7]	10	114.3[109.1,134.7]	<0.001 ^b
Polypoid mass/mound	80	8(10.0)	70	0(0.0)	10	8(80.0)	<0.001 ^c
Months to 1st polypoid mass/mound	8	118.4[95.6,153.2]	—	—	8	118.4[95.6,153.2]	—
Largest polypoid mass/mound	7		—		7		—
- 11-20 mm		1(14.3)		—		1(14.3)	
- >20		6(85.7)		—		6(85.7)	
Months to largest polypoid mass/mound	7	124.7[116.5,155.8]	—	—	7	124.7[116.5,155.8]	—

Statistics presented as Mean ± SD, Median [P25, P75], Median (Min, Max) or N (column %).

p-values: a=ANOVA, b=Kruskal-Wallis test, c=Pearson's chi-square test, d=Fisher's Exact test.

Table 3. EGD Findings

Factor	Overall		No GC		GC		p-value
	N	Statistics	n	Statistics	n	Statistics	
<i>Proximal Polyposis Pathology</i>							
Intestinal Metaplasia	80	5(6.3)	70	2(2.9)	10	3(30.0)	0.013^d
Months to 1st Intestinal Metaplasia	5	49.5(5.3,131.1)	2	80.9(30.8,131.1)	3	49.5(5.3,124.7)	—
FGP-no dysplasia	80	57(71.3)	70	49(70.0)	10	8(80.0)	0.51 ^c
Months to 1st FGP-no dysplasia	57	0.00[0.00,35.3]	49	0.00[0.00,36.0]	8	0.00[0.00,0.00]	0.16 ^b
FGP-LGD	80	48(60.0)	70	38(54.3)	10	10(100.0)	0.006^c
Months to 1st FGP-LGD	48	31.1[0.00,64.6]	38	34.3[0.00,58.6]	10	24.8[0.00,89.5]	0.92 ^b
FGP-HGD	80	9(11.3)	70	5(7.1)	10	4(40.0)	0.002^c
Months to 1st FGP-HGD	9	108.4(43.8,207.3)	5	104.9(43.8,119.8)	4	125.0(95.3,207.3)	—
PGA-no dysplasia	80	0(0.0)	70	0(0.0)	10	0(0.0)	—
PGA-LGD	80	4(5.0)	70	3(4.3)	10	1(10.0)	0.42 ^d
Months to 1st PGA-LGD	4	88.8(25.2,135.4)	3	47.8(25.2,129.9)	1	135.4	—
PGA-HGD	80	2(2.5)	70	0(0.0)	10	2(20.0)	0.014^d
Months to 1st PGA-HGD	2	165.4(124.7,206.0)	0	—	2	165.4(124.7,206.0)	—
TA	80	7(8.8)	70	4(5.7)	10	3(30.0)	0.011^c
Months to 1st TA	7	0.00(0.00,150.3)	4	0.00(0.00,150.3)	3	113.8(0.00,124.7)	—
TA-HGD	80	2(2.5)	70	1(1.4)	10	1(10.0)	0.24 ^d
Months to 1st TA-HGD	2	149.5(101.7,197.3)	1	197.3(197.3,197.3)	1	101.7	—
TVA	80	1(1.3)	70	0(0.0)	10	1(10.0)	0.13 ^d
Months to 1st TVA	1	60.6(60.6,60.6)	0	—	1	60.6	—
TVA-HGD	80	0(0.0)	70	0(0.0)	10	0(0.0)	—
VA	80	1(1.3)	70	0(0.0)	10	1(10.0)	0.13 ^d
Months to 1st VA	1	150.7(150.7,150.7)	0	—	1	105.7	—
VA-HGD	80	1(1.3)	70	0(0.0)	10	1(10.0)	0.13 ^d
Months to 1st VA-HGD	1	174.5(174.5,174.5)	0	—	1	174.5	—
Adenocarcinoma-intramucosal	80	2(2.5)	70	0(0.0)	10	2(20.0)	0.014^d
Months to 1st Adenocarcinoma-intramucosal	2	122.5(120.3,124.7)	0	—	2	122.5(120.3,124.7)	—
Adenocarcinoma-invasive	80	3(3.8)	70	0(0.0)	10	3(30.0)	0.001^d
Months to 1st Adenocarcinoma-invasive	3	155.8(133.6,226.5)	0	—	3	155.8(133.6,226.5)	—

Statistics presented as Mean ± SD, Median [P25, P75], Median (Min, Max) or N (column %).

p-values: a=ANOVA, b=Kruskal Wallis test, c=Pearson's chi-square test, d=Fisher's Exact test.

OC154 - CONCORDANCE BETWEEN MSI AND IHC IN THE UNIVERSAL SCREENING TUMOR AT BARRETOS™ CANCER HOSPITAL, A PUBLIC HEALTH CANCER CENTER IN BRAZIL.

E. I. Palmero¹, A. Escremim de Paula¹, G. Carvalho Fernandes¹, C. da Silva Sabato¹, G. Noriz Berardinelli¹, R. M. Reis¹, H. Campos Reis Galvão²

¹Molecular Oncology research Center, Barretos Cancer Hospital, Brazil Barretos, ²Oncogenetics Department, Barretos Cancer Hospital, Brazil Barretos

Lynch syndrome (LS) is an autosomal dominant cancer predisposition syndrome caused by mutations in the DNA mismatch repair (MMR) genes *MLH1*, *MSH2*, *MSH6* and *PMS2*. Individuals with LS have an increased risk of colorectal cancer, endometrial, ovarian and others. The detection has evolved from a clinical diagnosis to tumor-based screening. Notably, half of LS patients fail to meet the Amsterdam criteria. On the other side, MSI (Microsatellite instability), MMR IHC (Immunohistochemistry) or both, detect >90% of LS patients. Given its importance in clinical practice, 5 years ago the Barretos Cancer Hospital implemented a screening approach to identify patients at-risk for LS. Therefore, the objective of this project was to show the experience of a Public Health System Hospital from Brazil in the identification of patients/families at-risk for LS. Pentaplex mononucleotide PCR for MSI was compared to IHC of MMR genes in a cohort with clinical criteria (Amsterdam and Bethesda), cancer family history or early onset of colorectal cancer patients. Additional molecular testing including tumor *BRAF* mutation analysis and *MLH1* hypermethylation testing was performed to exclude LS. Molecular genetic testing was performed for all patients with altered MSI and/or IHC. We calculated Cohen's Kappa Statistic to define the accuracy and sensitivity of MMR IHC and MSI assays. 344 LS suspect patients (families) were evaluated, 18 and 24 were *BRAF* V600E and *MLH1* methylation tumor positive, respectively. Nine cases present inconclusive MSI and/or IHC and were excluded. Comparison of both MSI and IHC status was complete for 293 cases (Normal MSI/IHC: 200 cases; Discordant MSI/IHC result: 22 cases; Abnormal MSI/IHC: 71 cases). Overall agreement between methods was 92.5% (Kappa coefficient= 0.81). The genetic testing was performed for 93 patients, of which 54 (58%) had pathogenic mutation in one of the MMR genes. The sensitivity and PPV (Predictive Positive Value) were 85% and 62% for MSI, and 96% and 52% for IHC respectively. Considering MSI and IHC results together, the sensitivity for LS identification was 96%. The results shows that both, MSI testing and IHC presented high sensitivity to the identification of families at-risk for LS. Our experience highlights the importance of adoption of these screening methods in the clinical practice, especially in public health centers and in underdeveloped countries with limited financial resources to performed molecular genetic testing.

OC163 - GERMLINE PREDISPOSITION TO SERRATED POLYPOSIS SYNDROME INCLUDING EVIDENCE FOR RNF43 AS A SUSCEPTIBILITY GENE

D. Buchanan¹, M. Clendenning¹, C. Rosty², S. Joseland³, S. Woodall⁴, J. Arnold⁴, M. Lorans¹, D. Park⁵, F. Hammet⁵, T. Nguyen-Dumont⁵, M. Southey⁷, B. Pope⁶, K. Mahmood⁶, K. Semotiuk⁷, M. Aronson⁷, S. Holter⁷, S. Gallinger⁸, A. Win³, M. Jenkins³, K. Sweet⁹, F. Macrae¹⁰, I. Winship¹⁰, S. Parry⁴

¹Colorectal Oncogenomics Group, Department of Pathology, The University of Melbourne Melbourne, ²Envoi Specialist Pathologists Brisbane, ³Centre for Epidemiology and Biostatistics, Melbourne School of Population and Global Health, The University of Melbourne Melbourne, ⁴New Zealand Familial Gastrointestinal Cancer Service, Auckland, New Zealand Auckland, ⁵Genetic Epidemiology Laboratory, Department of Pathology, The University of Melbourne Melbourne, ⁶Victorian Life Sciences Computation Initiative, The University of Melbourne Melbourne, ⁷Zane Cohen Centre for Digestive Diseases, Familial Gastrointestinal Cancer Registry, Mt Sinai Hospital Toronto, ⁸Lunenfeld Tanenbaum Research Institute, Mount Sinai Hospital, University of Toronto Toronto, ⁹Division of Human Genetics, Ohio State University Medical Centre Columbus, ¹⁰Genetic Medicine and Family Cancer Clinic, Royal Melbourne Hospital Melbourne

Background: Serrated Polyposis Syndrome (SPS) is a disorder characterised by the presence of multiple serrated polyps in the large intestine and an increased risk of colorectal cancer (CRC). Findings limited to Northern European ancestry and increased risk of CRC in relatives of affected individuals suggest an inherited syndrome. Recent studies have reported germline pathogenic variants in the *RNF43* gene in rare affected families. A large and systematic screen for genetic risk factors for SPS was necessary to assess the relevance of genetic factors, including in *RNF43*, for SPS.

Methods: The Genetics of Colonic Polyposis Study (GCPS) has recruited 430 SPS-affected probands, meeting WHO criteria 1 or 3, from Genetics/Family Cancer Clinics across Australia, New Zealand, USA and Canada. We selected a subset of 74 SPS cases for whole exome sequencing (WES, n=58) or whole genome sequencing (WGS, n=16), including 65 probands and 8 first-degree relatives, based on clinical criteria (young age at diagnosis, high polyp burden, familial clustering). A further 230 SPS cases were screened using a multiplexed PCR-based target-enrichment (Hi-Plex) covering the coding regions of *RNF43*, *POLE*, *POLD1* and *NTHL1*. Single nucleotide variants and small indels were prioritised based on i) had not been reported previously or ii) were present in ExAC at <0.1% minor allele frequency and iii) if they resulted in loss of protein function (LoF: truncating or splice site) or iv) non-synonymous (Missense) changes predicted to have deleterious effect on protein function as determined by ≥ 4 out of 5 *in silico* variant effect prediction tools.

Results: Of the 74 SPS cases tested by WGS/WES, no likely pathogenic germline variants were identified in established hereditary CRC or polyposis genes. Of the total 304 SPS cases screened for the four candidate SPS genes: one patient (0.3%), who was diagnosed with 30 hyperplastic polyps, CRC aged 61 years and breast cancer aged 62 years, was heterozygous for both the c.268C>T, p.Gln90* and the c.235_236insG:p.Ala79fs LoF mutations in *NTHL1*. For *RNF43*, variants were identified in 5/304 (1.6%) SPS cases tested. The *RNF43* c.340C>T, p.R114W variant segregated in a SPS-affected sibling pair (ages at SPS diagnosis were 15 and 21 years). Efforts to identify novel SPS susceptibility gene/s will be presented.

Conclusions: Evidence for risk of SPS associated with variants in *RNF43* was found in a large scale genetic screen in a selected cohort with strong phenotype.

OC164 - RISK OF COLORECTAL CANCER FOR CARRIERS OF A GERMLINE MUTATION IN POLE OR POLD1

A. Win¹, J. Stewart¹, M. Clendenning¹, C. Rosty², M. Jenkins¹, J. Hopper¹, M. Southey¹, F. Macrae³, I. Winship³, D. Buchanan¹
¹The University of Melbourne Melbourne, ²University of Queensland Brisbane, ³The Royal Melbourne Hospital Melbourne

Background: Rare germline variants within the polymerase proofreading domains of the *POLE* and *POLD1* genes have been identified as likely highly penetrant colorectal cancer (CRC) susceptibility mutations (referred to as polymerase proofreading-associated polyposis), however this risk is yet to be quantified.

Methods: Variants within the exonuclease domains of *POLE* and *POLD1* identified from the literature were re-annotated and considered to be likely pathogenic if they were predicted to have deleterious effects in ≥ 4 out of 5 *in silico* tools. Additional *POLE* or *POLD1* mutations were identified among 669 CRC cases diagnosed before age 60 years from the Australasian Colorectal Cancer Family Registry (ACCFR). We estimated the hazard ratios (HRs) and 95% confidence intervals (CIs) of CRC for carriers compared with the general population (based on age, sex- and country-specific incidences), and hence the age-specific cumulative risks (penetrance) using a modified segregation analysis.

Results: Of the 37 rare variants (MAF ≤ 0.002) from 15 studies, 30 were predicted to be pathogenic by *in silico* criteria. We identified 34 families with *POLE* mutations and 7 families with *POLD1* mutations from published studies and 3 families with *POLE* mutations from ACCFR. We observed 67 CRCs with a mean age at diagnosis of 51.5 (standard deviation [SD] 14.8) years among 391 first- and second-degree relatives (52% female) from *POLE* mutation families, and 6 CRCs with a mean age at diagnosis of 39.7 (SD 6.83) years among 70 first- and second-degree relatives (44% female) from *POLD1* mutation families. The cumulative risks to age 70 years (95%CI) for males and females, respectively, were: 40% (26-57%) and 32% (20-47%) for *POLE* mutation carriers; and 63% (15-99%) and 52% (11-99%) for *POLD1* mutation carriers. We estimated the HR (95% CI) to be 19.2 (11.4-32.1) and 37.3 (6.2-226) for *POLE* and *POLD1* mutation carriers, respectively. The recurrent mutation in *POLE* c.1270C>G, p.(Leu424Val) was reported in 19 families. For these specific mutation carriers, the estimated cumulative risks to age 70 years (95% CI) were 98% (86-99%) for males and 95% (77-99%) for females and HR (95%CI) was 156 (74.5-327) for both sexes combined.

Conclusions: The elevated CRC risks for *POLE* and *POLD1* mutation carriers, particularly for carriers of the recurrent *POLE* c.1270C>G, p.(Leu424Val) mutation, warrant consideration of annual colonoscopy surveillance and clinical management guidelines comparable to those currently recommended for Lynch syndrome.

OC166 - PREVALENCE OF GERMLINE MUTATIONS IN *FAN1* IN FAMILIAL AND EARLY-ONSET COLORECTAL CANCERS

D. Buchanan¹, M. Clendenning¹, C. Rosty², A. Connor³, D. Duggan⁴, G. Casey⁵, S. Thibodeau⁶, L. Valle⁷, M. Lorans¹, D. Park⁸, F. Hammet⁸, T. Nguyen-Dumont⁸, M. Southey⁸, B. Pope⁹, K. Mahmood⁹, J. Hopper¹⁰, A. Win¹⁰, I. Winship¹¹, F. Macrae¹¹, S. Gallinger¹², M. Jenkins¹⁰

¹Colorectal Oncogenomics Group, Department of Pathology, The University of Melbourne Melbourne, ²Envoi Specialist Pathologists Brisbane, ³University of Toronto Toronto, ⁴Genetic Basis of Human Disease Division, Translational Genomics Research Institute Phoenix, ⁵Center for Public Health Genomics, University of Virginia Charlottesville, ⁶Mayo Clinic Rochester, ⁷Hereditary Cancer Program, Catalan Institute of Oncology Spain, ⁸Genetic Epidemiology Laboratory, Department of Pathology, The University of Melbourne Melbourne, ⁹Victorian Life Sciences Computation Initiative, The University of Melbourne Melbourne, ¹⁰Centre for Epidemiology and Biostatistics, Melbourne School of Population and Global Health, The University of Melbourne Melbourne, ¹¹Genetic Medicine and Family Cancer Clinic, Royal Melbourne Hospital Melbourne, ¹²Lunenfeld Tanenbaum Research Institute, Mount Sinai Hospital, University of Toronto Toronto

Background: Only a small proportion of the heritable risk for colorectal cancer (CRC) can be attributed to mutations within known CRC-associated genes, suggesting that additional CRC-predisposition genes are yet to be discovered. Recently, mutations in the *FAN1* gene were identified in 3% of families with a strong family history of CRC fulfilling the criteria for Familial Colorectal Cancer Type X (FCCTX). The aim of this study was to determine the prevalence and mutation spectrum of germline *FAN1* mutations in broader categories of familial and early-onset CRC cases from the Australasian Colorectal Cancer Family Registry (ACCFR).

Methods: Whole genome (30x) or exome (100x) sequencing was performed on n=204 CRC cases from 90 families (1 to 4 CRC-affected individuals per family) with a family history of CRC including 55 who fulfilled FCCTX criteria. A second cohort of n=800 early-onset CRC cases (i.e. age <60 years at diagnosis) from the ACCFR are currently being screened using multiplexed PCR-based target-enrichment (Hi-Plex), covering the coding region of *FAN1*. Single nucleotide variants (SNVs) and small indels in the *FAN1* gene were considered likely pathogenic variants if they i) had not been reported previously or ii) were present in ExAC at <0.1% minor allele frequency and iii) if they likely resulted in loss of protein function (LoF: truncating or splice site) or iv) non-synonymous changes predicted to have deleterious effect on protein function as determined by ≥ 4 out of 5 *in silico* variant effect prediction tools. Genotyping of the identified variant in families was performed to determine segregation with CRC, polyps or other cancers.

Results: WGS/WES identified 3 likely pathogenic *FAN1* variants in 4 multiple-case CRC families (4.4%). One of these variants (c.2854C>T p.Arg952*) was found in 4 relatives (3 with CRC and one with bone marrow cancer diagnosed at age 41 yrs) from the same FCCTX family. This LoF variant has been previously reported in a Spanish family, however, analysis of microsatellites flanking the mutation indicated independent origins for the mutation in these two families. Results from the tumour analysis and targeted screen of *FAN1* in the ~800 young-onset CRC cases will be presented.

Discussion: We identified additional CRC-affected families segregating likely pathogenic *FAN1* SNVs, supporting *FAN1* as a CRC susceptibility gene. These early results justify further studies of the role of *FAN1* in early-onset and familial CRC patients.

OC167 - EXOME SEQUENCING IDENTIFIED POTENTIAL CANDIDATE GENES FOR SERRATED POLYPOSIS SYNDROME

S. Peters¹, C. Trueck¹, J. Altmueller², K. Kayser¹, E. Mangold¹, S. Holzapfel³, R. Adam⁴, H. Thiele⁵, I. Spier³, S. Aretz³

¹Institute of Human Genetics, University of Bonn Bonn, Germany, ²Cologne Center for Genomics and Institute of Human Genetics, University of Cologne Cologne, Germany, ³Institute of Human Genetics and Center for Hereditary Tumor Syndromes, University of Bonn Bonn, Germany, ⁴Institute of Human Genetics and Center for Hereditary Tumor Syndromes, University of Bonn Amsterdam, Netherlands, ⁵Cologne Center for Genomics, University of Cologne Cologne, Germany

Background: Serrated hyperplastic polyposis syndrome (SPS), also known as hyperplastic polyposis syndrome (HPS), is a still poorly defined colorectal cancer (CRC) predisposition characterized by the occurrence of multiple and/or large serrated lesions throughout the colon. To date, only few molecular signatures have been described and neither the etiology of the syndrome nor the distinct genetic alterations have been identified.

Methods: To uncover predisposing causative mutations, the exomes of 31 clinically well characterized SPS patients (27 unrelated index patients with sporadic appearance and four affected patients from two families) have been sequenced (Illumina HiSeq) using leukocyte DNA. The germline variants were filtered for rare (homozygous/compound heterozygous: $MAF \leq 1\%$, heterozygous: $MAF \leq 0.1\%$ according to dbSNP, EVS, and ExAC), truncating, and missense variants if predicted to be pathogenic by $\geq 2/3$ in silico tools (MutationTaster, PolyPhen2, SIFT). Functional scores were included to further characterize the genes (z-, pLI-, RVIS-, and HI-score). For data analysis and filtering, the GATK software and the Cartagenia Bench Lab NGS Software were applied.

Results: After stringent filtering steps and manual inspection, potentially biallelic variants were found in 60 genes, some of which are recurrently mutated or functioning in pathways associated with tumorigenesis. The most promising seven candidate genes are affected by biallelic truncating mutations with two patients carrying a homozygous nonsense mutation in one specific gene.

All in all, 334 genes harbored heterozygous variants in at least two patients. These encompass 40 cancer genes or genes of cancer-associated pathways including the Wnt-signalling pathway. Here, the most interesting finding was a heterozygous *RNF43* splice site mutation identified in an index patient and his affected daughter.

Conclusions: The data indicate that exome sequencing might identify potentially causative germline variants underlying the susceptibility to SPS. The current work-up consists of the validation of variants by Sanger sequencing, testing of relatives to determine the zygosity of assumed biallelic variants, and analyzing the segregation with the phenotype, where applicable. Furthermore, screening of additional SPS patients for the most interesting variants and functional analyses of these variants are planned.

OC169 - SOMATIC CAUSES OF TUMOUR MISMATCH REPAIR-DEFICIENCY IN LYNCH-LIKE COLORECTAL AND ENDOMETRIAL CANCERS

M. Clendenning¹, C. Rosty², H. Jayasekara¹, J. Joo³, M. Wong³, R. Walters⁴, N. O'Callaghan¹, S. Preston¹, K. Mahmood⁵, J. Hopper⁶, R. Milne⁷, G. Giles⁷, D. English⁶, M. Southey³, M. Jenkins⁶, F. Macrae⁸, B. Pope⁵, A. Win⁶, A. Spurdle⁹, I. Winship⁸, D. Buchanan¹
¹Colorectal Oncogenomics Group, Genetic Epidemiology Laboratory, Department of Pathology, The University of Melbourne Melbourne, ²Envoi Specialist Pathologists Brisbane, ³Genetic Epidemiology Laboratory, Department of Pathology, The University of Melbourne Melbourne, ⁴Department of Genetics and Computational Biology, Queensland Institute of Medical Research Brisbane, ⁵Victorian Life Sciences Computation Initiative, The University of Melbourne Melbourne, ⁶Centre for Epidemiology and Biostatistics, Melbourne School of Population and Global Health, The University of Melbourne Melbourne, ⁷Cancer Epidemiology Centre, Cancer Council Victoria Melbourne, ⁸Genetic Medicine and Family Cancer Clinic, Royal Melbourne Hospital Melbourne, ⁹Department of Genetics and Computational Biology, Queensland Institute of Medical Research Melbourne

Background: A high proportion of individuals affected with colorectal cancers (CRCs) or endometrial cancers (ECs) that demonstrate tumour mismatch repair (MMR) deficiency are categorised as having “Lynch-like syndrome”(LLS), due to the absence of tumour *MLH1* methylation or germline MMR gene mutations after standard screening approaches. The aims of this study were to investigate somatic causes of tumour MMR-deficiency and to study survival in individuals with LLS.

Methods: Study participants with incident MMR-deficient CRC (n=193 from the Australasian Colorectal Cancer Family Registry (ACCFR) and Melbourne Collaborative Cohort Study (MCCS)) or EC (n=197 from the Australian National Endometrial Cancer Study (ANECS) and the MCCS) were categorised as either Lynch Syndrome (LS) (germline MMR gene mutation), or having *MLH1* methylation or LLS. Lynch-like tumours were tested for somatic MMR gene mutations using AmpliSeq-Ion Proton custom capture sequencing and for *MSH2* or *MSH6* gene promoter methylation using the Illumina Infinium HumanMethylation450K array. Overall survival for LLS CRCs was compared to LS related CRCs using Cox regression models to estimate hazard ratios (HR) and 95% confidence intervals (CIs), adjusting for age at diagnosis, sex, AJCC stage and grade.

Results: Across all the MMR-deficient CRCs and ECs, LLS tumours comprised 32% (63/193) and 23% (45/197), respectively, compared with 27% and 15% for the LS group and 41% and 62% for *MLH1* methylated tumours. Of the LLS CRCs and ECs tested, two somatic mutations were identified in 37% (18/49) and 48% (11/23), respectively. *MSH2*-deficient CRCs and ECs had the highest frequency of double somatic mutations across the different patterns of MMR IHC loss (40% and 64%, respectively). The mean age at diagnosis for the LLS CRCs with double somatic mutations was 49.7 ± 15.8 years, not significantly different from LS CRCs (n=52; 45.4 ± 11.3 years; p=0.2) but was significantly different to the *MLH1* methylated CRCs (n=83; 70 ± 8.9 years; p=0.0001). No evidence of tumour *MSH2* or *MSH6* gene promoter methylation was identified in either *MSH2*-deficient or *MSH6*-deficient LLS CRCs or ECs tested (n=34 and n=12, respectively). LLS CRCs with double somatic mutations showed an overall poorer survival compared with LS CRCs but did not reach statistical significance (HR=2.58, 95% CI, 0.77-8.67; p=0.1).

Conclusions: Double somatic mutations in the MMR genes represent a significant proportion of the unexplained LLS MMR-deficient subtype of CRC and EC in the population. Clinical triaging strategies used to identify Lynch syndrome for both CRC and EC should include tumour testing for somatic mutations in the MMR genes.

OC170 - THE IMPORTANCE OF DATA SHARING IN CLASSIFICATION OF VARIANTS IN MISMATCH REPAIR GENES

T. Pesaran¹, B. Smith¹, L. Hoang¹, K. Jasperson¹, J. Dolinsky¹, C. Espenschied¹

¹Ambry Genetics Aliso Viejo

Background: Classification of variants identified in high penetrance mismatch repair (MMR) genes *MLH1* and *MSH2* can be greatly impacted by data such as clinical phenotype, tumor characteristics, co-occurrence and segregation data. Classifications of rare variants can be based on internal laboratory data that is not publicly available. We sought to compare InSiGHT's classification to that of a clinical laboratory's classification and the impact of internal data.

Methods: We queried the InSiGHT LOVD database for alterations with classifications on January 1, 2017 and compared to Ambry Genetics database. Class 1 and 2 variants were grouped as clinically non-actionable and class 4 and 5 were grouped as clinically actionable. Variants were considered discordant if they were class 3 (unknown significance) vs. class 1/2 (non-actionable) or class 4/5 (actionable). Internal lines of evidence used for classification were reviewed.

Results: 537 *MLH1* and 473 *MSH2* alterations with classifications were identified in the InSiGHT database, of which 254 (47%) of *MLH1* and 239 (51%) of *MSH2* had an Ambry classification. Variants had concordant classifications in 216/254 (85%) for *MLH1* and 200/237(84%) for *MSH2*. The majority of discordant classifications were variants where InSiGHT classification was class 3 due to limited information: 34/38 (89%) in *MLH1* and 31/37(84%) in *MSH2*. Of the InSiGHT *MLH1* class 3 discordant variants, 25/34 (74%) were due to internal data including co-occurrence (N=10), tumor MSI/IHC (N=14), segregation (N=8) and presence or lack of Lynch associated phenotypes (N=24). Where 13/25 (52%) were downgraded to class 1 or 2 and 12/25 (28%) were upgraded to class 4 or 5. Of the InSiGHT *MSH2* class 3 discordant variants, 25/31 (80%) were due to internal data, including co-occurrence (N=17), tumor MSI/IHC (N=14), segregation (N=6) and presence or lack of Lynch associated phenotypes (N=25). Where 21/25 (84%) were downgraded to class 1 or 2 and 4/25 (16%) were upgraded to class 4 or 5.

Conclusions: Tumor data, co-segregation, co-occurrence and phenotypes are well established lines of evidence that can be provided by clinical laboratories to assist classifying variants in MMR genes. The majority of classifications that resulted in up or downgrading a VUS, were due to internal data. As expert groups such as InSiGHT are tasked with providing classification guidance internationally this highlights the importance of establishing data sharing collaborations with clinical laboratories for variant classification.

OC171 - WHOLE GENOME SEQUENCING AS A DIAGNOSTIC TOOL FOR LYNCH SYNDROME

B. Pope¹, M. Clendenning², K. Mahmood¹, C. Rosty³, R. Walters⁴, A. Win⁵, J. Hopper⁵, M. Southey⁶, F. Macrae⁷, I. Winship⁸, M. Jenkins⁵, A. Spurdle⁴, D. Buchanan²

¹Victorian Life Sciences Computation Initiative, The University of Melbourne Melbourne, ²Colorectal Oncogenomics Group, Genetic Epidemiology Laboratory, Department of Pathology, The University of Melbourne Melbourne, ³Envoi Specialist Pathologists Brisbane, ⁴Department of Genetics and Computational Biology, Queensland Institute of Medical Research Brisbane, ⁵Centre for Epidemiology and Biostatistics, Melbourne School of Population and Global Health, The University of Melbourne Melbourne, ⁶Genetic Epidemiology Laboratory, Department of Pathology, The University of Melbourne Melbourne, ⁷Colorectal Medicine and Genetics, Royal Melbourne Hospital Melbourne, ⁸Genetic Medicine and Family Cancer Clinic, Royal Melbourne Hospital Melbourne

Background: A high proportion of patients with tumours that have mismatch repair (MMR) deficiency are categorised as having “Lynch-like syndrome” (LLS) because standard screening approaches have been unable to identify a causative germline MMR gene mutation or somatic *MLH1* methylation. The aim of this study was to investigate the application of whole genome sequencing (WGS) to identify novel germline causes, including structural variation, of tumour MMR-deficiency and Lynch syndrome.

Methods: We performed WGS on 16 LLS patients (including 2 relative pairs), in whom no MMR mutation had been found after Sanger sequencing and MLPA testing, who were selected for family history of cancer and/or young age at diagnosis. Two previously identified mutation carriers (*MSH2* exon 6 deletion and *MSH2* intron 1 c.212-478T>G mutation) were also sequenced as positive controls. Single nucleotide variants (SNVs) and short insertions and deletions (INDELS) were called using the GATK Best Practices Pipeline and annotated using the Ensembl, SnpEff and CADD Variant Effect Predictor tools. Structural variants (SVs) were detected using four tools: DELLY, LUMPY, Socrates and GRIDSS, prioritising high-confidence SV calls by applying quality filters and concordance between tools. Gene variants were prioritised based on occurrence in the MMR genes (Tier 1) and then other DNA repair genes (Tier II: including *MUTYH*, *POLE*, *EXO1*).

Results: SV analysis identified a 47.7MB inversion including exons 1-7 of *MSH2* in a mother-daughter pair, both with *MSH2*-deficient colorectal cancers (CRCs). Validation by PCR-based assay confirmed the inversion and identified a further 3 carriers, 2 of whom had CRC. Additional candidate SVs identified included an intronic deletion in *MSH2* in a woman with the endometrial cancer and an inversion in *MUTYH* gene in a man with *MLH1*/*PMS2*-deficient CRC. After filtering and annotation, we obtained a list of 9631 SNVs/INDELS across all samples. The top candidate likely pathogenic SNVs identified were in *EXO1*, *LIG1*, *MUTYH* and *POLE* including the *POLE* p.Arg680Cys SNV which showed evidence of segregation with CRC and polyp affected relatives.

Conclusions: WGS can identify people with Lynch syndrome among those with LLS. It also has the potential to identify novel susceptibility genes and mutations outside the current gene screening paradigm and, therefore, enables stratification of people with LLS and their families into different risk categories for more optimal clinical management.

OC173 - TUMOUR DNA METHYLATION SIGNATURE DEFINES COLORECTAL CANCERS FROM BIALLELIC MUTYH MUTATION CARRIERS

J. Joo¹, M. Wong¹, C. Rosty², M. Clendenning³, F. Macrae⁴, I. Winship⁵, A. Win⁶, P. Newcomb⁷, N. Lindor⁸, L. LeMarchand⁹, R. Haile¹⁰, G. Casey¹¹, S. Gallinger¹², J. Hopper⁶, R. Milne¹³, G. Giles¹³, D. English⁶, M. Southey¹, M. Jenkins⁶, D. Buchanan³

¹ Genetic Epidemiology Laboratory, Department of Pathology, The University of Melbourne Melbourne, ²Envoi Specialist Pathologists Brisbane, ³Colorectal Oncogenomics Group, Genetic Epidemiology Laboratory, Department of Pathology, The University of Melbourne Melbourne, ⁴Colorectal Medicine and Genetics, Royal Melbourne Hospital Melbourne, ⁵Genetic Medicine and Family Cancer Clinic, Royal Melbourne Hospital Melbourne, ⁶Centre for Epidemiology and Biostatistics, Melbourne School of Population and Global Health, The University of Melbourne Melbourne, ⁷Public Health Sciences Division, Fred Hutchinson Cancer Research Center Seattle, ⁸Department of Health Science Research, Mayo Clinic Arizona Scottsdale, ⁹University of Hawaii Cancer Center Honolulu, ¹⁰Medicine, Division of Oncology, Stanford Cancer Institute, Stanford University California, ¹¹Center for Public Health Genomics, University of Virginia Charlottesville, ¹²Lunenfeld Tanenbaum Research Institute, Mount Sinai Hospital, University of Toronto Toronto, ¹³Cancer Epidemiology Centre, Cancer Council Victoria Melbourne

Background: Carriers of germline biallelic mutations in the base excision repair gene, *MUTYH*, are almost certain to develop colorectal cancer (CRC). Given the well-understood role of DNA methylation in colorectal tumorigenesis, we hypothesised that there are DNA methylation signatures associated with the colorectal tumours of *MUTYH* germline biallelic mutation carriers that discriminate them from other sporadic CRCs. In this study, we tested this by assessing methylation of CRC tumour and matched normal mucosa tissues from *MUTYH* biallelic mutation carriers and sporadic cases.

Method: Using the Illumina Infinium HumanMethylation450K (HM450K) array, we measured genome-wide methylation on a test set of 192 formalin-fixed paraffin embedded tumour and matched normal samples from 96 CRC-affected patients. Nine of those 96 CRC-affected individuals were biallelic carriers of a germline mutation at the *MUTYH* locus, recruited from the Colon Cancer Family Registry Cohort (Colon-CFR). Sixty-nine individuals were late-onset “sporadic” cases, recruited through the Melbourne Collaborative Cohort Study (MCCS). The remaining 18 cases were either familial CRC cases, or carriers of an *MLH1* epimutation or germline mutations in the DNA mismatch repair genes (Lynch syndrome). The replication group comprised 13 CRCs from biallelic *MUTYH* mutation carriers (Colon-CFR) and 552 unselected CRCs from the MCCS. The HM450K data were processed using the *minfi* Bioconductor package. Differentially Methylated Probes (DMPs) were assessed by performing a regression analysis using the *limma* Bioconductor package.

Results: We successfully measured methylation at >450,000 CpG probes for all 192 tumour and matched normal samples. We observed extensive DNA methylation differences between tumour and matched normal samples with a set of >250,000 statistically significant DMPs (False discovery rate (FDR) adjusted p-value < 0.01). Further analysis identified 15 differentially methylated probes specific to the CRCs from *MUTYH* biallelic mutation carriers (i.e. differences not present or much weaker in sporadic CRCs). These probes overlapped the *MRSB3*, *TNFRSF4*, *GIMAP5*, *RNASE9*, *ZC3H3*, *PTBP2*, *HAUS5*, *PGCP*, *CD109*, *C7orf58*, *FAM184A*, and *UNC50* genes, where tumours were consistently more methylated than normal tissues. We further tested methylation at these CpG probes in a replication group of 13 *MUTYH* biallelic CRCs and 552 sporadic CRCs. We found significant methylation differences between the two groups for 4 of these 15 CpG probes (overlapping *c7orf58*, *PTBP2*, *MSRB3*, *PGCP*).

Conclusion: We identified a DNA methylation signature in CRCs from biallelic *MUTYH* mutation carriers that can differentiate this clinically important subgroup of patients from those with sporadic tumours and from other inherited CRC syndromes.

OC179 - COMPREHENSIVE ANALYSIS OF THE MLH1 PROMOTER REGION IN 480 COLORECTAL CANCER PATIENTS AND 1150 CONTROLS REVEALS ONE VARIANT INDUCING A HERITABLE CONSTITUTIONAL MLH1 EPIMUTATION

M. Morak¹, A. Ibsler², G. Keller³, E. Jessen⁴, A. Laner⁵, D. Gonzales-Fassrainer⁵, M. Locher⁵, T. Massdorf⁶, A. Nissen⁵, A. Benet-Pagès⁵, E. Holinski-Feder¹

¹Medizinische Klinik und Poliklinik IV, Campus Innenstadt, Klinikum der Universität München and MGZ München Munich, ²Ruhr-Universität Bochum Bochum, ³Institute of Pathology, Technical University Munich, ⁴Praxis für Humangenetik Hamburg, ⁵MGZ "Medizinisch Genetisches Zentrum Munich, ⁶Medizinische Klinik und Poliklinik IV, Campus Innenstadt, Klinikum der Universität München Munich

Lynch Syndrome (LS) represents the most common dominantly inherited colorectal cancer (CRC) predisposition which is caused by a heterozygous germline defect affecting one of the DNA mismatch repair genes *MLH1*, *MSH2*, *MSH6*, or *PMS2*. The pathomechanism on the gene is usually based on small nucleotide variants (SNVs), small insertions/deletions (indels) or on single/multiple exon deletions. In the small subset of LS patients with a „constitutional *MLH1* epimutation“, the germline *MLH1* promoter methylation results in transcriptional repression and also represents a functional defect of the *MLH1* gene. Abnormal methylation is usually based on a *de-novo* event and is not heritable due to the epigenetic reprogramming in germline formation. However, a variant-induced constitutional *MLH1* epimutation can be inherited, as it was described for one single variant c.[-27C>A;85G>T].

We sequenced the *MLH1* promoter region in sixteen patients with a constitutional *MLH1* epimutation, and 37 CRC patients with unsolved loss of MLH1 expression in their tumours to investigate promoter changes that might be causative. Furthermore, we analysed 102 CRC patients with loss of MLH1 expression due to CIMP (CpG island methylator phenotype) in their tumours, 83 LS patients with loss of MLH1 expression due to pathogenic *MLH1* germline variants, 242 patients with MLH1-proficient CRC, and 1150 patients with non LS-tumours to correctly judge the results.

We report a novel, complex *MLH1* promoter variant c.-63_-58delins18 detected in a CRC patient and his sister, both presenting constitutional *MLH1* epimutation. The variant allele reveals a complete allele-specific promoter methylation in different tissues. We observed complete transcriptional silencing of the variant allele in cDNA from blood of the patient and his sister. With this finding, we add a second variant stably inducing a constitutional *MLH1* epimutation.

None of the other nine rare promoter variants detected in seventeen individuals were associated with methylation in blood or tumor. To investigate an allele-specific reduction of transcription, we performed cDNA analyses and tested the expression of heterozygous variants for six promoter variants with normal, biallelic findings.

Conclusion: Variants with an impact on transcription or methylation are only rarely identified in the *MLH1* promoter region. We add a second promoter variant stably inducing a constitutional *MLH1* epimutation and classify several promoter variants as non-pathogenic.

OC181 - DETECTION OF DNA DELETIONS AND DUPLICATIONS IN NEXT-GENERATION SEQUENCING GENE PANEL DATA OF PATIENTS WITH FAMILIAL GASTRO-INTESTINAL CANCER

L. F. Johansson¹, A. P. Knoppers¹, K. K. van Dijk-Bos¹, H. Westers¹, M. A. Swertz¹, R. J. Sinke¹, B. Sikkema-Raddatz¹, R. H. Sijmons¹
¹University Medical Center Groningen, Department of Genetics Groningen, The Netherlands.

Next-generation sequencing (NGS) of gene panels has quickly become first choice of DNA testing in familial cancer. Our department has implemented custom made gene panels capturing regions of 73 (first design) and 85 (second design) tumor syndrome genes. Typically, only single nucleotide variants (SNVs) and insertions or deletions of one or a few nucleotides (Indels) are analyzed. However, larger deletions or duplications of one or more exons will be overlooked in this approach. We have developed a method to detect these types of aberration in the NGS gene panel data combining our in-house developed tool CoNVaDING[1] and XHMM[2]. We have analyzed 1246 patients with familial cancer (503 and 743 with the respective panels), of whom in total 238 were referred because of familial gastrointestinal (GI) tumors. Of these, 70 were analyzed retrospectively with all 'obvious' genes previously tested with negative results 168 were tested prospectively. In the patients with GI cancer 1 pathogenic SNV or Indels was detected in the retrospective group and 15 in the prospective group. In total 1 (1.4%) and 5 (2.6%) deletions and duplications were identified in the retrospective and prospective GI group, respectively. In none of these patients a pathogenic SNV or Indel had been identified. In the retrospective group in one patient with familial colorectal cancer a duplication was found of the entire *EPCAM* gene and neighboring exon 1-8 of *MSH2*. Previously in this patient the tumor was shown to be MSI high, also *MLH1* was shown to be methylated in tumor material and not in normal material. *MLH1* and *PMS2* had a negative immunohistochemical staining. In the prospective group a deletion of *EPCAM* exons 5-9 and two duplications of *CHEK2* exon 3 and the entire *POLE* gene were found in patients with familial colorectal cancer. In two patients with polyposis duplications were found of the entire *MUTYH* gene and of *TP53* exons 9-12. Of these, only the deletion in *EPCAM* was classified as pathogenic. All duplications were considered VUS, although further testing may well confirm a pathogenic effect. These results suggest that calling deletions of whole exons in panel data is a valuable addition to the diagnostics of familial GI cancer. For the clinical classification of duplications additional experiments are needed to decide on pathogenicity.

References:

1. Johansson et al. (2016), Hum Mut 37(5):457-64
2. Fromer et al. (2012), Am J Hum Genet 91:597-607

OC184 - GENETIC SUSCEPTIBILITY IN ATTENUATED ADENOMATOUS POLYPOSIS

V. Lorca¹, L. Martan¹, P. Llovet¹, D. Rueda², C. Poves³, M. J. Fernandez-Aceero⁴, P. Perez-Segura⁵, B. Garca-Paredes⁶, V. Garca-Barberin¹, M. de La Hoya¹, T. Caldos¹, P. Garre¹

¹Molecular Oncology Lab. HCSC Madrid, ²Biochemistry Dpt. H120 Madrid, ³Gastroenterology Dpt. HCSC Madrid, ⁴Pathology Dpt. HCSC Madrid, ⁵Genetic Counseling Unit, Oncology Dpt. HCSC Madrid, ⁶Medical Oncology Dpt. HCSC Madrid

Attenuated adenomatous polyposis (AAP) is a heterogeneous syndrome according to the clinic manifestations, heritability and etiology of the disease. Genetic heterogeneity and low penetrance alleles are probably the best explanation for this variability. Certainly, it is known that APC and MUTYH are high penetrance predisposition genes for adenomatous polyposis but they only account for 5-10 % of AAP. Other new predisposition genes, such as POLE, POLD1, NTHL1 or MSH3, have been recently described and associated to AAP but all together seem to explain even fewer cases than the formers. In addition, it has been observed some AAP cases due to mutations in genes that usually cause other polyposis syndromes. For all these reasons multigenic panels become a powerful tool which can improve the genetic diagnosis in this group giving insights about the underlying genetic causes and improving the genetic counseling of these patients.

In order to evaluate the genetic predisposition of AAP in a hospital based population, we have tested 163 patients showing more than 10 adenomatous polyps by the analysis of a custom NGS gene panel, which included all coding sequences and intron-exon boundaries of 22 genes that have ever been associated with adenomatous polyposis predisposition. Our results reflect a high genetic heterogeneity and overlapping between different syndromes that could explain almost a half of the unexplained AAP population. Not only APC and MUTYH mutations have been detected, but also pathogenic mutations in other polyposis genes such as BMPR1A or PTEN as well as a high number of unclassified variants. Contrary to expectations, no AAP case could be explained by pathogenic mutations in any of the new discovery high predispositions AAP genes but digenic inheritance between heterozygous mutations in NHTL1 and POLE is suggested.

This work gives insights about the different genetic subgroups of AAP and it strongly supports the necessity of wide multigenic panels for the accurate genetic diagnosis of AAP syndromes.

OC191 - OXIDATIVE DNA DAMAGE INDUCES HYPOMETHYLATION IN A COMPROMISED BASE EXCISION REPAIR COLORECTAL TUMOURIGENESIS

D. Furlan¹, D. Trapani², E. Berrino³, M. Panero³, C. Debernardi³, L. Libera¹, N. Sahnane¹, C. Riva¹, M. G. Tibiletti¹, F. Sessa¹, A. Sapino³, T. Venesio³

¹Anatomic Pathology Unit, Surgical and Morphological Sciences Department, University of Insubria 21100 Varese, Italy, ²Anatomic Pathology Unit, Surgical and Morphological Sciences Department, University of Insubria 21100 Varese (Italy), ³Molecular Pathology Lab, Unit of Pathology, Candiolo Cancer Institute 10060 Candiolo (Torino), Italy

Background: A compromised base excision repair (BER) promotes carcinogenesis by accumulating oxidative DNA damaged products as observed in *MUTYH*-associated polyposis, a hereditary colorectal cancer syndrome marked by adenomas and cancers with an accumulation of 8-oxoguanine. Remarkably, DNA global demethylation has been shown to be mediated by BER suggesting a relevant interplay with early colorectal tumourigenesis. To check this hypothesis, we investigated a cohort of 49 adenomas and 10 carcinomas, derived from 17 *MUTYH*-associated polyposis patients; as adenoma controls we used a set of 36 familial adenomatous polyposis and 24 sporadic polyps.

Methods: Samples were analysed for their mutational and epigenetic status, measured as global LINE-1 and gene specific LINE-1 *MET* methylation by mass spectrometry and pyrosequencing.

Results: *MUTYH*-associated polyposis adenomas were strikingly more hypomethylated than familial adenomatous and sporadic polyps for both DNA demethylation markers ($P=0.032$ and $P=0.007$ for LINE-1; $P=0.004$ and $P<0.0001$ for LINE-1 *MET*, respectively) with levels comparable to those of the carcinomas derived from the same patients. They also had mutations due mainly to *KRAS/NRAS* p.G12C which was absent in the controls ($P<0.0001$ for both sets).

Conclusions: Our results show that DNA demethylation, together with specific *KRAS/NRAS* mutations, drives the early steps of oxidative damage colorectal tumourigenesis.

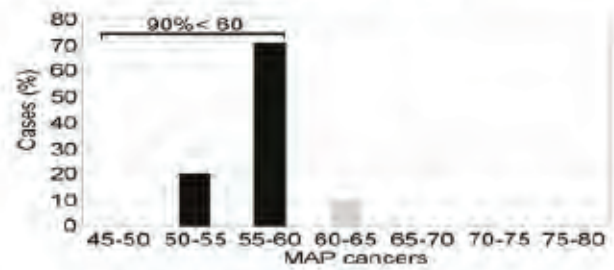
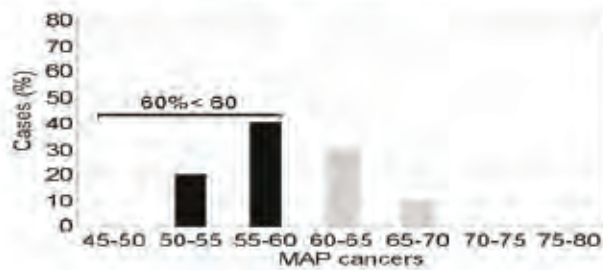
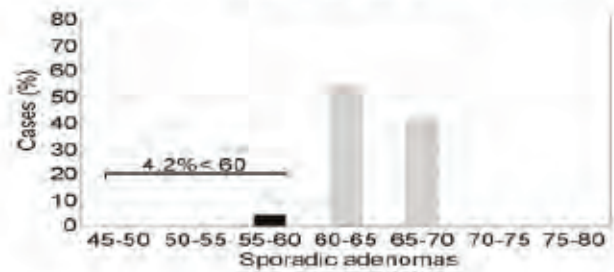
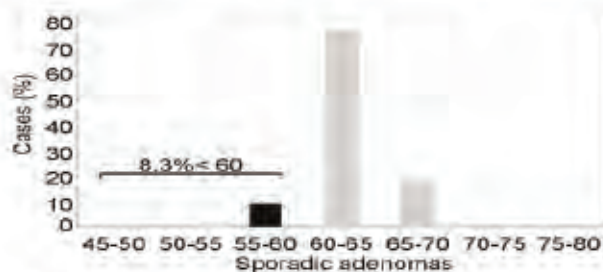
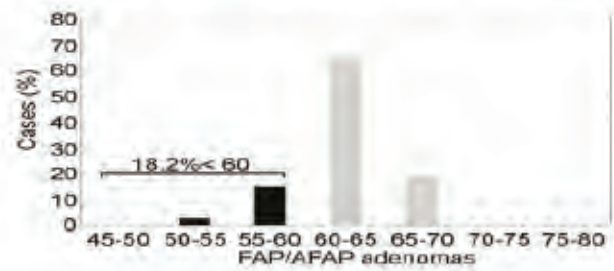
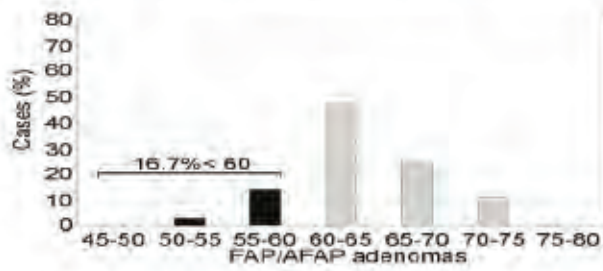
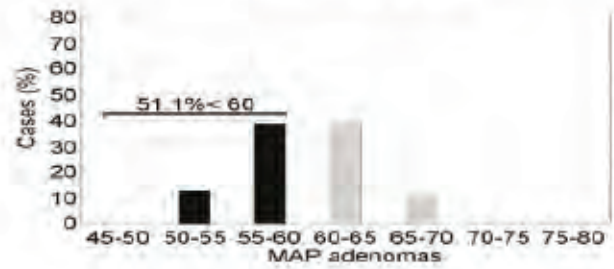
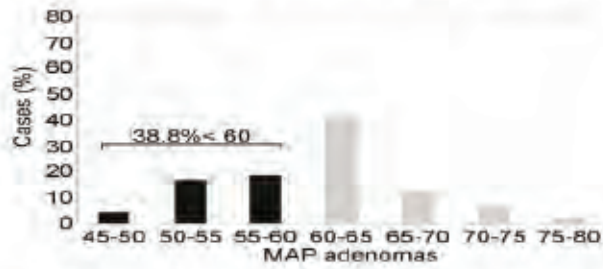
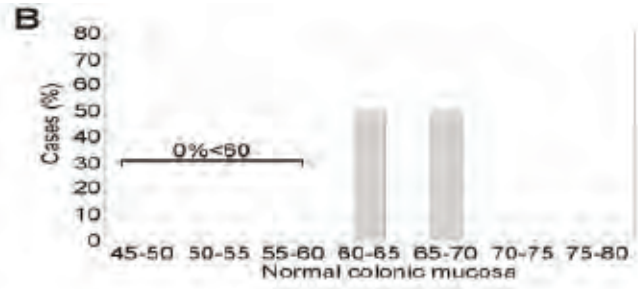
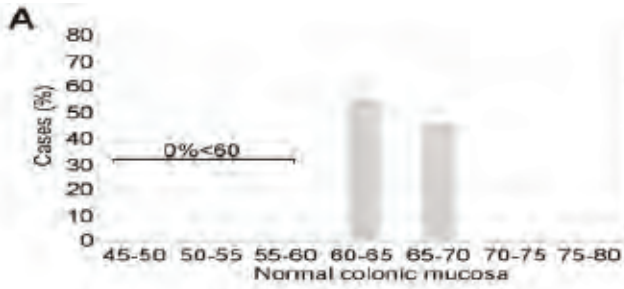

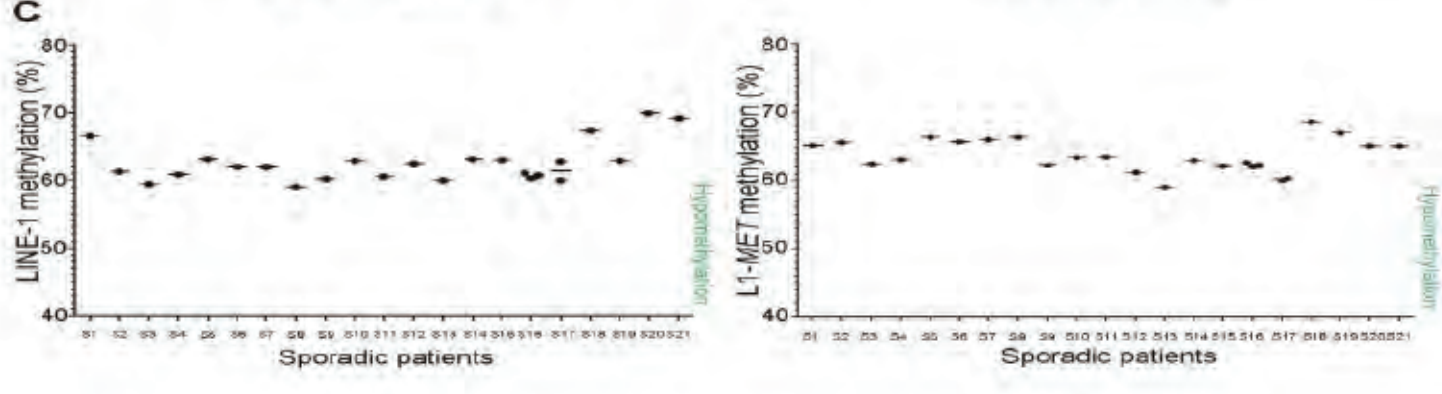
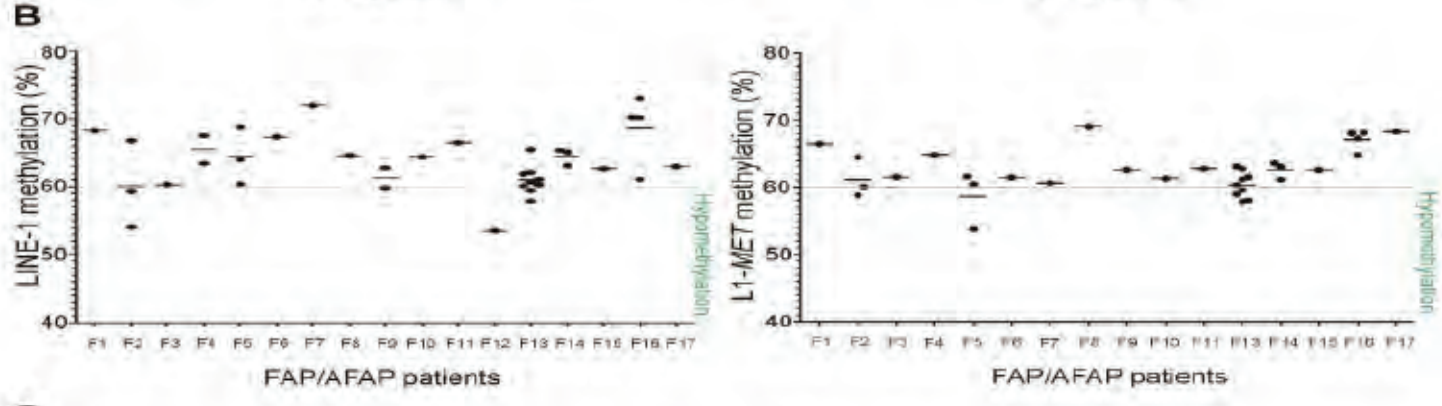
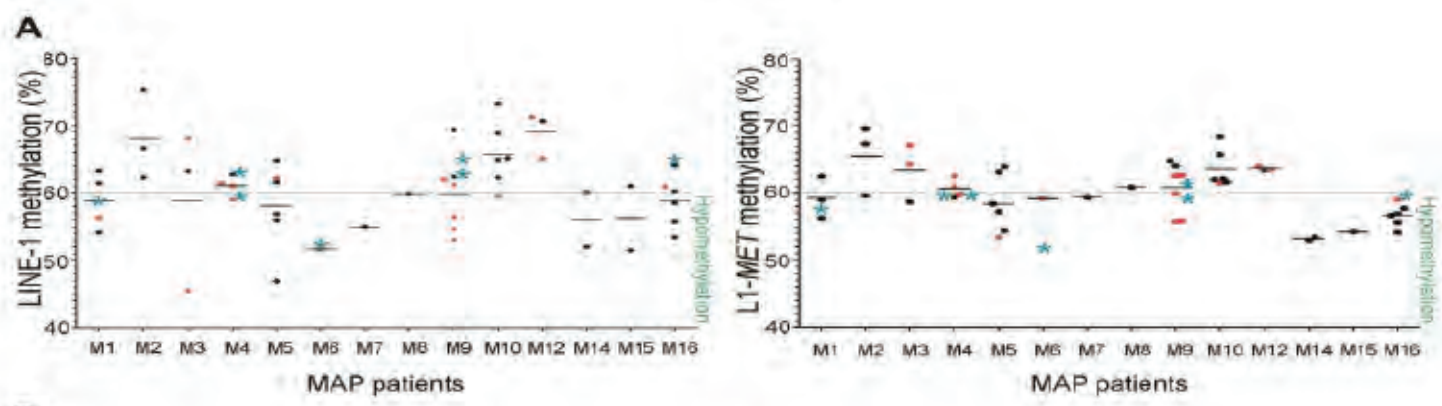

- *KRAS/NRAS* p.G12C mutation
- WT or other *KRAS/NRAS* mutations
- ★ MAP cancer
- Methylation average
- Methylation threshold

OC193 - SHORTAGE OF MLH1 AND CHROMOSOMAL SEGREGATION-SPECIFIC GENE TRANSCRIPTS IN COLON MUCOSA SIGNAL CARCINOMA

M. Pussila¹, P. Täräinen¹, E. Einarsdottir², S. Katayama², K. Krjutiková², L. Holm¹, J. Kere², P. Peltomäki³, M. Mäkinen⁴, J. Linden⁵, M. Nyström¹

¹Department of Biosciences, University of Helsinki Helsinki, ²Department of Biosciences and Nutrition, Karolinska Institutet Huddinge, ³Department of Medical and Clinical Genetics, University of Helsinki Helsinki, ⁴Department of Pathology, University of Oulu Oulu, ⁵Department of Basic Veterinary Sciences, University of Helsinki Helsinki

Most colorectal cancers (CRC) develop without inherited predisposition although 15% reveal microsatellite instability (MSI), the hallmark of Lynch syndrome, resulting from mismatch repair (MMR) malfunction, typically caused by inactivation of *MLH1*. But what about development of the other 85% of CRCs without MSI? We used a mouse model to study cancer preceding expression changes in colon mucosa, tumor phenotypes, and the effect of risk factors, Western diet and inherited predisposition on those. We found, that *Mlh1* mRNA expression was significantly decreased in the normal mucosa of wildtype *Mlh1*^{+/+} and heterozygote *Mlh1*^{+/-} mice that developed CRC. However, Mlh1 protein was present and there was no MSI in the CRCs of the respective mice. Furthermore, the expression profiles of histologically normal mucosa of CRC mice, analyzed by RNA sequencing, formed a distinct cluster with shortage of chromosomal segregation gene-specific transcripts. Our findings suggest that decreased mRNA expression of Mlh1 and chromosomal segregation genes may form a field-defect in histologically normal mucosa and trigger MMR-proficient, chromosomally unstable CRC when combined with other adverse effects, such as Western diet.

OC195 - BURDEN AND PROFILE OF SOMATIC MUTATION IN DUODENAL ADENOMAS FROM PATIENTS WITH FAMILIAL ADENOMATOUS AND MUTYH-ASSOCIATED POLYPOSIS

L. E. Thomas¹, J. J. Hurley¹, E. Meuser¹, S. Jose¹, K. Ashelford¹, M. Mort¹, S. Idziaszczyk¹, J. Maynard¹, H. Leon-Brito¹, M. Harry¹, A. Walters¹, M. Raja¹, S. Walton², S. Dolwani¹, G. T. Williams¹, M. Morgan³, M. Moorghen², S. K. Clark², J. R. Sampson¹

¹School of Medicine, Cardiff University Cardiff, ²The Polyposis Registry, St Mark's Hospital London, ³Department of Pathology, University Hospital for Wales Cardiff

Background

Duodenal polyposis and cancer are important but poorly understood causes of morbidity and mortality in familial adenomatous polyposis (FAP) and *MUTYH*-associated polyposis (MAP). Molecular studies of duodenal tumorigenesis in FAP and MAP are virtually non-existent and the underlying genetic mechanisms of adenoma development in both disease contexts remain unclear. This study aimed to characterise somatic genetic changes in duodenal adenomas from patients with FAP and MAP to better understand duodenal tumorigenesis in these disorders.

Methods

Sixty-nine adenomas were biopsied during upper GI endoscopy in 16 FAP patients and 10 MAP patients with duodenal polyposis. Ten FAP and 10 MAP adenomas and matched blood DNA samples were subject to whole exome sequencing; 42 further adenomas underwent targeted sequencing and 47 were studied by array comparative genomic hybridisation. Findings in FAP and MAP duodenal adenomas were compared to each other and to the reported mutational landscape in FAP and MAP colorectal adenomas.

Results

Significant differences in the underlying mutational spectra were identified between FAP and MAP duodenal adenomas. MAP duodenal adenomas had significantly more protein-changing somatic mutations ($p = 0.018$), truncating mutations ($p = 0.006$) and copy number variants ($p = 0.005$) than FAP adenomas, even though MAP patients had lower Spigelman stage duodenal polyposis. Fifteen genes were mutated significantly more frequently than expected from the background mutation rate. Targeted sequencing of *APC*, *KRAS*, *PTCHD2* and *PLCL1* identified further mutations in each of these genes in additional duodenal adenomas but, in contrast to MAP and FAP colorectal adenomas, neither exome nor targeted sequencing identified any *WTX* mutations ($P=0.0017$).

Conclusions

The mutational landscapes in FAP and MAP duodenal adenomas overlap with, but have significant differences to those reported in colorectal adenomas. The significantly higher burden of somatic mutations in MAP than FAP duodenal adenomas could increase cancer risk in lower Spigelman grade disease.

OC198 - BRIDGING THE MISSING LINK BETWEEN GYNAECOLOGY AND GENETICS.

L. Andrews¹, H. Pokharel², N. Hacker²

¹Hereditary Cancer Clinic, Prince of Wales Hospital Randwick, ²Gynaecological Cancer Centre, Royal Hospital for Women Randwick

Introduction: A recent paper described the difference between *efficacy* and *effectiveness* with regard to the identification of BRCA1/2 mutation carriers amongst women diagnosed with breast cancer ⁽¹⁾. Gynaecological cancers have been recognised as the sentinel cancer in Lynch Syndrome as well as Hereditary Breast Ovarian Cancer, and provide an opportunity to identify families with MMR or BRCA1/2 mutations according to established guidelines ⁽²⁾.

Aim: To determine the effectiveness of genetic participation in gynaecological oncology multidisciplinary review meetings to prompt referral of women suitable for genetics assessment.

Methods: An audit was performed of gynaecological cancer cases presented at the Royal Hospital for Women 2010-2014 who were identified as requiring genetics assessment (further investigation of family history, MMR IHC, methylation studies or MMR or BRCA1/2 genetic testing) through RHW medical records and the New South Wales genetic database. The treating doctors of women who had not attended for recommended genetics assessment were contacted to determine the cause of non-attendance.

Results: Of 2523 cases of gynaecological cancer, 462 were recommended for further genetics assessment. 10 MMR and 40 BRCA1/2 mutation carriers were identified. At 1 year, 167 women had not had genetics assessment (36%) ⁽³⁾. Review at 2 years found that a further 13 had been seen by a genetics service, 17 were deceased, 4 moved outside of NSW, 5 declined, 10 were too unwell for further contact, and 14 were lost to follow up. Further evaluation of the family history of 83 women indicated no further assessment was required. 21 patients remained suitable for referral.

Overall, 71/462 (15%) potential cases of hereditary cancer have not been assessed, with 50 of those not ever going to be seen. Treating doctors of the remaining 21 women have been informed and have contacted their patients. The outcomes of this initiative will be reported, and several protocols to improve effectiveness will be presented.

Conclusion: While guidelines for referral of women newly diagnosed with gynaecological cancer may have high efficacy in identifying women with MMR or BRCA1/2 mutations, without systematic follow-up, potential carriers are lost, reducing the effectiveness of the guidelines.

1. Martin.P.Nillson et al. Familial Cancer, online 24 January 2017
2. www.eviq.org.au
3. Hanoon P Pokharel et al. ANZJOG 2016 **56**:633

OC204 - GERMLINE VARIANTS IN HOMOLOGOUS RECOMBINATION (HR)-MEDIATED DNA DAMAGE REPAIR GENES MAY CONTRIBUTE TO INCREASED CRC SUSCEPTIBILITY IN FCCTX FAMILIES

I. Francisco¹, A. Magalhães¹, B. Filipe¹, I. Claro², P. Lage², S. Ferreira², I. Rosa², P. Rodrigues³, P. Chaves⁴, A. Dias Pereira⁵, C. Albuquerque¹

¹Molecular Pathobiology Research Unit - Portuguese Institute of Oncology Francisco Gentil, EPE Lisbon, ²Familial Cancer Risk Clinic and Gastroenterology Department - Portuguese Institute of Oncology Francisco Gentil, EPE Lisbon, ³Familial Cancer Risk Clinic - Portuguese Institute of Oncology Francisco Gentil, EPE Lisbon, ⁴Pathology Department - Portuguese Institute of Oncology Francisco Gentil, EPE Lisbon, ⁵Gastroenterology Department - Portuguese Institute of Oncology Francisco Gentil, EPE Lisbon

Familial colorectal cancer type X (FCCTX) families are clinically defined by the Amsterdam criteria, absence of germline mutations in mismatch repair (MMR) genes and the presence of microsatellite stable tumors. Previously, we have reported the presence of two distinct molecular entities amongst tumors from 15 FCCTX families: one (n=10) whose tumors presented frequent loss of heterozygosity in tumor suppressor genes (TSG+) and another (n=5) with tumors lacking this molecular feature (TSG-). Amongst TSG+, we found a subgroup (n=7) with a prevalence of *APC/KRAS* somatic mutations and *MGMT/MMR* methylation, and a second, where these features were almost absent. Here, we aimed to characterize these distinct subgroups at the germline level by the analysis of a panel of 94 genes associated to increased cancer risk. Next generation sequencing was performed using the TruSight Cancer panel (Illumina, Miseq platform), in the 15 index patients previously studied. Large deletions/duplications were evaluated for all genes associated with hereditary colorectal cancer syndromes by MLPA. In 7/15 families, all TSG+, we found one or more likely pathogenic germline variants in genes encoding proteins involved in double strand breaks (DSB) associated DNA repair pathways, secondary to DNA damage response to genotoxic stress, particularly in homologous recombination (HR)-mediated DNA damage repair. Five of the seven families belong to the subgroup whose tumors presented frequent *KRAS* somatic mutation and/or *MGMT/MMR* gene methylation. In two of these families we have also detected a likely pathogenic missense mutation in *BMPRIA* gene and a deletion of *SMAD4* exons 5-8, respectively. The cytotoxic effects of alkylating agents, if not repaired by *MGMT* and MMR system, will eventually lead to DNA DSB. The latter, together with defects in HR-DNA repair pathways, will result in elevated chromosomal/DNA breakage and genome instability, which are consistent with the mutation signature previously reported by us in the FCCTX TSG+ subgroup. Therefore, germline defects in HR-DNA repair genes, identified in the present study, may contribute to increase colorectal adenoma/carcinoma risk in a subgroup of FCCTX families with TSG+ tumors, carrying frequent *KRAS* mutations and/or *MGMT/MMR* gene methylation.

OC206 - PRIMARY CONSTITUTIONAL MLH1 EPIMUTATIONS: A FOCAL EPIGENETIC EVENT

E. D'Ájmaso¹, A. Castillejo², M. D. M. Arias³, M. Navarro¹, J. del Valle¹, O. Campos¹, A. FernÁndez², F. Setien⁴, F. MarÁn¹, D. Turchetti⁵, J. D. D. GarcÁa-DÁaz⁶, M. Genuardi⁷, D. Rueda⁸, Á. Alonso³, J. L. Soto², M. Hitchins⁹, M. Pineda¹, G. CapellÁj¹

¹Hereditary Cancer Program, Catalan Institute of Oncology - Bellvitge Biomedical Research Institute (ICO-IDIBELL), CIBERONC L'Hospitalet de Llobregat, Barcelona, Spain, ²Hereditary Cancer Program Valencian Region, Molecular Genetics Laboratory, Elche University Hospital Elche, Alicante, Spain, ³Genetics Service, Complejo Hospitalario de Navarra Pamplona, Navarra, Spain, ⁴Cancer Epigenetics and Biology Program (PEBC), Bellvitge Biomedical Research Institute (IDIBELL) L'Hospitalet de Llobregat, Barcelona, Spain, ⁵Dipartimento di Scienze Mediche e Chirurgiche, Alma Mater Studiorum - UniversitÁ di Bologna Bologna, Italy, ⁶Unidad de GenÁtica ClÁnica, Servicio de Medicina Interna, Hospital Universitario PrÁncipe de Asturias AlcalÁ de Henares, Madrid, Spain, ⁷Genetics Medicine Institute, Catholic University of the Sacred Heart Rome, Italy, ⁸Hereditary Cancer Genetic Diagnostic Laboratory, Doce de Octubre University Hospital Madrid, Spain, ⁹Department of Medicine, Division of Oncology, Stanford University Stanford, California, United States

Introduction: Constitutional *MLH1* epimutations are an alternative cause for Lynch syndrome, characterized by monoallelic methylation of the *MLH1* promoter throughout normal tissues, resulting in allele-specific loss of *MLH1* expression. While secondary epimutations are caused by an adjacent genetic alteration and are dominantly transmitted, primary epimutations typically arise *de novo* and are reversible between generations. The aim of this study was to perform a molecular characterization of constitutional *MLH1* epimutations aiming at the elucidation of their causal mechanism.

Patients and methods: Twelve carriers of *MLH1* constitutional epimutation (4 of them previously unreported) were recruited. Global methylome analysis was performed using Infinium 450K array (Illumina) in blood DNA from all 12 *MLH1* epimutation carriers, 61 Lynch syndrome patients (19 *MLH1*-mutated) and 42 healthy controls. A variety of sequencing techniques, SNUPE and customized CGH arrays were used to further characterize *MLH1* epimutation carriers. Inheritance pattern was determined by MS-MLPA and haplotype analyses.

Results: The *EPM2AIP1-MLH1* CpG island was the sole differentially methylated region (FDR<0.05) in *MLH1* epimutation carriers compared to Lynch syndrome cases or healthy controls, pointing to it as the candidate region to search for the causal mechanism for epimutations. No germline point mutations or structural variants were identified *in-cis* on the methylation-associated allele in 10 epimutation carriers, suggesting these are cases of primary epimutation. In one of these patients, the promoter variant c.-234_-236del was identified *in-trans*. Small deletions (range size 15-20 Kb) outside the *EMP2AIP1-MLH1* CpG island were found in 2 patients (phase unknown). In 5 patients heterozygous at rs1799977 the transcriptional silencing of the methylated allele was evidenced. Intergenerational erasure of the epimutation was demonstrated in two families.

Conclusions: Suspected primary constitutional *MLH1* epimutations arise as a focal epigenetic event covering the *EPM2AIP1-MLH1* CpG island and are not associated with cis-acting genetic variants. Refined molecular characterization is needed to elucidate the mechanistic basis of *MLH1* constitutional epimutations and their heritability/reversibility.

OC212 - DISTINCT PATTERNS OF SOMATIC MOSAICISM IN THE APC GENE IN NEOPLASMS FROM PATIENTS WITH UNEXPLAINED ADENOMATOUS POLYPOSIS

A. M. L. Jansen¹, S. Crobach¹, W. R. R. Geurts-Giele², B. E. W. M. van den Akker¹, M. Ventayol Garcia¹, D. Ruano¹, M. Nielsen³, C. M. J. Tops³, J. T. Wijnen³, F. J. Hes³, T. van Wezel¹, W. N. M. Dinjens², H. Morreau¹

¹Department of Pathology, Leiden University Medical Center Leiden, ²Department of Pathology, Erasmus MC Cancer Institute, University Medical Center Rotterdam, ³Department of Clinical Genetics, Leiden University Medical Center Leiden

Background and aims: Somatic *APC* mosaicism is an underestimated cause of attenuated familial adenomatous polyposis. In this study we analyzed the prevalence and patterns of *APC* mosaicism in unexplained colorectal polyposis patients.

Methods: Using DNA from at least two adenomas or carcinomas per patient, we analyzed 27 patients for mosaic *APC* variants using next-generation sequencing. In cases of mosaicism, all available adenomas were tested, together with DNA from normal colonic mucosa and leukocytes when available.

Results: Somatic mosaicism, with identical *APC* variants in multiple adenomas, was identified in nine of 18 patients with 21-100 adenomas (50%). In three patients a mosaic variant was detected in leukocyte DNA at a frequency of less than 5%, two patients showed a mosaic variant confined to adenomas and normal colonic mucosa and in two patients the mosaic variant was not detected in leukocyte DNA (no normal colonic mucosa available). In a comprehensive sequence analysis of 1 patient, we found no evidence for mosaicism in *APC* in non-neoplastic intestinal mucosa. One patient was found to carry a c.4666dupA mosaic *APC* variant in only 10 of 16 adenomas.

Conclusion: Deep sequencing of multiple colonic adenomas may reveal remarkable patterns of novel *APC* mosaicism, such as an absence of the mosaic variant from normal mucosa and a mix of adenomas with and without a mosaic *APC* variant. The latter finding underlines the importance of screening at least three adenomas.

OC215 - GERMLINE VARIANTS IN DNA INTERSTRAND-CROSS LINK REPAIR GENES MAY CONTRIBUTE TO INCREASED SUSCEPTIBILITY FOR SERRATED POLYPOSIS

P. Silva¹, I. Francisco¹, B. Filipe¹, P. Lage², I. Claro², R. Fonseca³, S. Ferreira², I. Rosa², P. Rodrigues⁴, P. Chaves³, A. Dias Pereira⁵, C. Albuquerque¹

¹Molecular Pathobiology Research Unit - Portuguese Institute of Oncology Francisco Gentil, E.P.E. Lisbon, ²Gastroenterology Department and Familial Cancer Risk Clinic - Portuguese Institute of Oncology Francisco Gentil, E.P.E. Lisbon, ³Pathology Department - Portuguese Institute of Oncology Francisco Gentil, E.P.E. Lisbon, ⁴Familial Cancer Risk Clinic - Portuguese Institute of Oncology Francisco Gentil, E.P.E. Lisbon, ⁵Gastroenterology Department - Portuguese Institute of Oncology Francisco Gentil, E.P.E. Lisbon

Serrated polyposis (SP) is characterized by the development of multiple colorectal serrated polyps and increased predisposition to colorectal cancer (CRC). However, the molecular basis of SP, especially in cases presenting family history of SP and/or polyps and/or CRC in first degree relatives (SP-FHP/CRC), is still poorly understood. In a previous study, we have reported that SP-FHP/CRC patients present differences with respect to clinical and histological features when compared to apparently sporadic SP patients. In addition, we proposed the existence of two molecular entities amongst SP-FHP/CRC families, proximal/whole-colon and distal SP-FHP/CRC, according to the preferential location of lesions and somatic events involved in tumour initiation: *MGMT* and mismatch repair (MMR) gene defects, followed by Wnt gene mutations, in the former, and mutations in the RAS/RAF genes in the latter. This points out for the involvement of distinct tumorigenic pathways in these two forms of SP-FHP/CRC and led us to suggest that the early *MGMT* and MMR gene deficiency may underlie an inherited susceptibility to genotoxic stress in the proximal form.

In the present study we aimed to characterize these distinct subgroups of SP-FHP/CRC at the germline level by the analysis of a multigene panel of 94 genes associated to increased cancer risk.

Next generation sequencing was performed using TruSight Cancer panel, in a Miseq platform, in 10 SP-FHP/CRC patients (6 with proximal/whole-colon and 4 with distal SP-FHP/CRC) and in 3 apparently sporadic SP patients previously studied.

Likely pathogenic germline variants in genes coding for proteins involved in the Fanconi Anemia (FA) pathway that act downstream of FA complex to facilitate DNA Interstrand-Cross Link repair (ICLR) were detected in 4/10 SP-FHP/CR patients. These germline variants were found in the proximal/whole-colon SP-FHP/CRC group (4/6). We found mutations in genes coding for DNA nucleotide excision repair (NER) proteins in 2/3 apparently sporadic SP patients.

DNA damage caused by alkylating agents, if not repaired by *MGMT* and MMR system, may lead to DNA double-strand breaks. The latter, together with defects in DNA-ICLR pathway, will result in elevated chromosomal/DNA breakage and genome instability, consistent with the mutation signature previously reported by us in the proximal/whole-colon SP-FHP/CRC subgroup. Therefore, germline defects in DNA-ICLR genes, identified in the present study, may contribute to increase serrated colorectal polyps/carcinoma risk in a subgroup of SP-FHP/CRC. Moreover, defects in NER genes may account for a subgroup of apparently sporadic SP patients.

OC216 - RAISING THE AGE LIMIT FOR ROUTINE MMR TESTING IN CRC FROM 50 TO 70 YEARS IMPROVES RECOGNITION OF NEW LYNCH SYNDROME FAMILIES

N. Hoogerbrugge¹, I. E. Fakkert¹, R. W. Willems², Y. K. Peeks¹, S. Langenveld³, I. D. Nagtegaal², E. M. Leter³, A. R. Mensenkamp¹, L. Spruijt⁴, M. Ligtenberg⁴

¹Department of Human Genetics, Radboud university medical center Nijmegen, The Netherlands, ²Department of Pathology, Radboud university medical center Nijmegen, The Netherlands, ³Department of Clinical Genetics, Maastricht University Medical Center Maastricht, The Netherlands, ⁴Department of Human Genetics, Radboud university medical center; Department of Pathology, Radboud university medical center Nijmegen, The Netherlands

Background: To improve recognition of Lynch syndrome (LS), in the revised Dutch guideline for hereditary colorectal cancer (CRC), the age-limit for tumor testing of newly diagnosed CRCs for mismatch repair (MMR) deficiency by the pathologist was raised from 50 to 70 years. Referral for genetic counseling is advised for patients with MMR deficient CRC without MLH1 hypermethylation and for all patients with CRC before age 40.

Aim: To improve LS recognition by stimulating implementation of the revised guideline for hereditary CRC.

Methods: The Dutch Pathology Registry (PALGA) was used to evaluate tumor testing in 14 pathology laboratories. Patients referred to two regional clinical genetic centers were coupled to PALGA data to evaluate referral rates. Every three months, pathology laboratories received feedback on percentage of CRCs tested for MMR deficiency testing, and hypermethylation of MLH1 in microsatellite instable or MLH1 deficient CRC.

Results:

MMR testing:

From January 15th to October 2016, in 1499 of 1951 (77%) CRCs before age 70 MMR tumor test results were available. From the first to the third quarter of 2016, mean MMR deficiency testing percentage in individual pathology laboratories increased from 70% [range 22–95] to 79% [4–100] and hypermethylation testing from 91% [50–100] to 97% [67–100].

LS recognition:

Of 68 CRC patients with MMR test results suggestive for LS, 30 (44%) were referred for genetic counseling. In eight of 18 (44%) patients with complete genetic diagnostic workup, germline LS mutations were found, comprising all LS genes (MLH1, MSH2, MSH6, PMS2, EPCAM). Of these newly identified LS patients, six (75%) represent previously unknown LS families. Five of these six (83%) patients had CRC between age 50 and 70, and did not comply with former referral criteria on age at diagnosis or family history.

Six (23%) of 26 patients with CRC before age 40 and normal or no MMR test results were referred. LS mutations were found in two of three patients with complete diagnostic genetic workup: one patient from a known MLH1 family with a false positive hypermethylation test and one with a homozygous frameshift mutation in the last exon of MSH2 which led to positive immunohistochemical staining of MSH2.

Conclusion: Raising the age limit for MMR-testing from 50 to 70 years is successful in improving recognition of new LS families, of which the majority would not have been identified by former referral criteria based on age at diagnosis or family history.

OC218 - LOCALIZATION OF ADENOMAS AFTER COLONIC SURGERY IN PATIENTS WITH FAMILIAL ADENOMATOUS POLYPOSIS

V. H. Roos¹, B. A. Bastiaansen¹, W. A. Bemelman², C. M. Aalfs³, P. M. Bossuyt⁴, E. Dekker¹

¹Department of Gastroenterology and Hepatology, Academic Medical Center Amsterdam, The Netherlands, ²Department of Surgery, Academic Medical Center Amsterdam, The Netherlands, ³Department of Human Genetics, Academic Medical Center Amsterdam, The Netherlands, ⁴Department of Epidemiology and Biostatistics, Academic Medical Center and University of Amsterdam Amsterdam, The Netherlands

Background

The mechanism of adenoma development in the ileum after colonic surgery in patients with familial adenomatous polyposis (FAP) is not well understood. Apart from the genetic background, luminal factors, such as fecal stasis, might contribute to the development of adenomas in the small bowel. To further explore this hypothesis, we compared the localization and burden of adenomas after end-ileostomy with the situation after proctocolectomy with ileoanal pouch-anastomosis in a large surveillance population.

Methods

We performed a historical cohort study of all FAP patients who received surveillance endoscopies at the Academic Medical Center in Amsterdam. The follow-up period was defined as the time between a surgical intervention (primary surgery or re-resection) and the last endoscopy.

Results

In total, 127 FAP patients were included of whom 25 patients underwent a total proctocolectomy with an end-ileostomy, and 102 patients had ileoanal pouch-anastomosis after proctocolectomy. Patients with an end-ileostomy were older (median 63 [IQR 50-70] vs 40 years [IQR 29-49]; $p < 0.001$), more frequently had a history of cancer (14/25 vs 14/100; $p < 0.001$) and upper gastrointestinal surgery (13/25 vs 15/102; $p < 0.001$).

We analyzed 27 follow-up periods in the end-ileostomy group and 109 follow-up periods in the ileoanal pouch group, since 9 patients underwent a re-resection of either the everted part of the stoma or the pouch. The median follow-up time was 7 years [IQR 3-14] for the ileoanal pouch-group versus 12 years [IQR 4-24] for the end-ileostomy group ($p = 0.003$). In the ileostomy group, 12/27 follow-up periods (44%) showed adenomas on either the everted part of the stoma (8/27) and/or in the efferent loop (6/27), compared to 72 of 109 (66%) in the pouch group ($p = 0.039$). Adenomas in the efferent loop of the ileoanal pouch were less common than in the pouch (19/108 vs 51/108, $p = 0.002$). The majority of the ileoanal anastomosis was stapled (64/84; $p < 0.001$) and contained more adenomas in the rectal cuff (42/64 vs 4/20; $p < 0.001$) than the hand sewn anastomosis. The median cumulative number of adenomas was higher in the ileoanal pouch group compared with the end-ileostomy group (4 [IQR 0-12] vs 0 [IQR 0-5]; $p = 0.003$). The median size of the most advanced adenoma was 3mm [IQR 2-5] vs 2mm [IQR 0-7] respectively ($p = 0.411$).

Conclusion

The prevalence of ileal adenomas after colectomy in FAP is significantly higher in patients that underwent ileoanal pouch reconstruction than those that underwent end-ileostomy. Since the pouch and the everted part of the stoma are both most in contact with feces, our results suggest that fecal stasis might contribute to the development of adenomas in the ileum after colonic surgery.

Follow-up after surgery

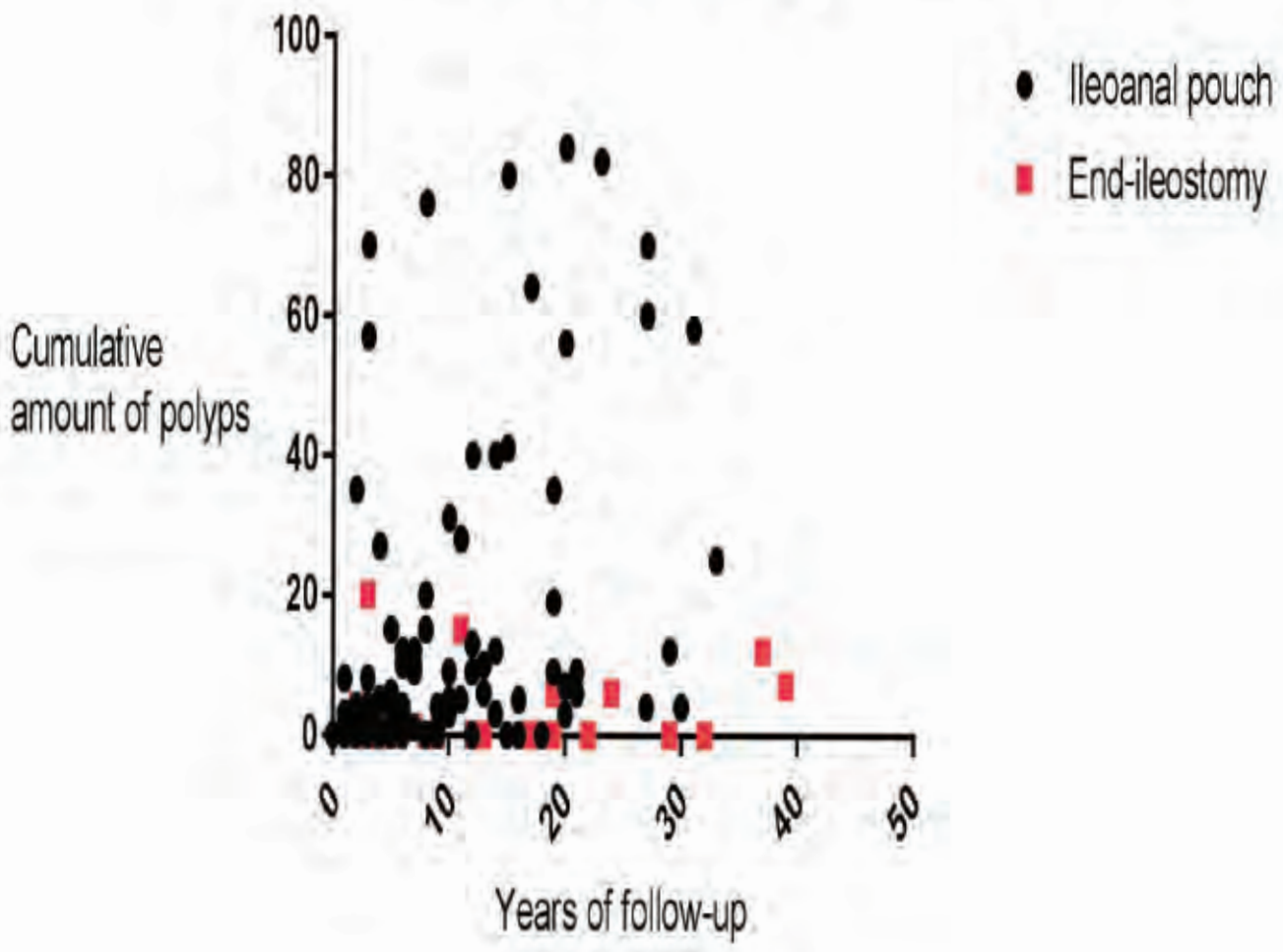

!

!

OC224 - ASPIRIN PROMOTES AN EPITHELIAL PHENOTYPE, REDUCES THE STEM CELL POPULATION AND INHIBITS WNT SIGNALLING IN COLORECTAL NEOPLASIA

K. Dunbar¹, A. Valanciute¹, T. Jamieson², K. Myant¹, O. Sansom², M. Arends¹, S. Farrington¹, M. Dunlop¹, F. Din¹
¹Institute of Genetics and Molecular Medicine Edinburgh, ²Cancer Research UK Beatson Institute Glasgow

Background: Colorectal cancer (CRC) is the fourth commonest cause of cancer deaths worldwide. The role of aspirin in cancer prevention is well-established with aspirin reducing CRC incidence. Evidence suggests aspirin may have post-diagnosis benefits with increased CRC survival rates. Loss of cell-cell junctions and the acquirement of a motile mesenchymal phenotype is facilitated by epithelial-mesenchymal transition (EMT) which is associated with CRC metastasis. Furthermore, EMT can induce a cancer stem cell (CSC) phenotype in tumour cell subsets which display increased therapeutic resistance. A potential mechanism for the post-diagnosis benefit of aspirin is the inhibition of EMT and CSC formation. Understanding the signalling pathways regulating EMT and CSC formation in cancer is important for preventing metastasis and combating therapeutic resistance. Aberrant Wnt signalling is an early characteristic in colorectal neoplasia and contributes to EMT and stem cell regulation. Here, we investigate the effect of aspirin on EMT, stem cell population and Wnt signalling in CRC cell lines, human familial adenomatous polyposis (FAP) colonic organoids and the *Apc*^{Min/+} mouse model.

Methods: We studied the effect of aspirin on CRC cell line migration and invasion using wound healing and organotypic invasion assays. Differences in markers of motility, EMT and stem cells were evaluated following aspirin treatment using western blotting, immunofluorescence and qRT-PCR. The effects of aspirin on EMT and stem cell markers were studied in human FAP colonic epithelial organoids and in *Apc*^{Min/+} mouse models.

Results: Aspirin inhibited CRC cell migration and invasion. The decreased migration was paralleled by inhibition of RhoA/ROCK1 motility signalling following aspirin. Aspirin increased E-cadherin (epithelial marker) and reduced mesenchymal marker expression in CRC cell lines, human colonic organoids and *Apc*^{Min/+} adenomas indicating inhibition of EMT. The characteristic cystic phenotype of “Wnt-driven” effects in APC-mutated human and mouse colonic epithelial organoids was rescued by aspirin, which promoted the “budding” phenotype more consistent with wild-type APC alleles. In parallel, aspirin decreased expression of stem cell markers (Lgr5, TROY) in APC- mutated human and mouse colonic epithelial organoids. Aspirin also decreases β -catenin expression and reduced Paneth cell number in *Apc*^{Min/+} adenomas.

Conclusion: Aspirin inhibits cellular migration, invasion, motility and promotes an epithelial phenotype in CRC cell lines. We also show that aspirin rescues the aberrant Wnt-driven cystic phenotype in human FAP and mouse adenoma models with a concomitant decrease in stem cell population and Wnt pathway inhibition. Our novel findings shed light on potential molecular mechanisms related with increased survival in CRC patients on aspirin post-diagnosis.

OC225 - DECISION FOR NON-COMPLETION OF FOLLOWUP AMONG PATIENTS WITH ABNORMAL SCREENING TEST FOR HEREDITARY COLORECTAL CANCER SYNDROME

S. Patel¹, M. Rodriguez-Bigas¹, M. Mork¹, S. Bannon¹, A. Cuddy¹, E. Vilar², M. Pande³, P. Lynch³, Y. N. You⁴

¹Surgical Oncology, University of Texas MD Anderson Cancer Center Houston, ²Medical Oncology, Cancer Prevention; University of Texas MD Anderson Cancer Center Houston, ³Gastroenterology, University of Texas MD Anderson Cancer Center Houston, ⁴Surgical Oncology, Cancer Prevention; University of Texas MD Anderson Cancer Center Houston

Purpose

Lynch Syndrome (LS) is associated with colorectal cancers (CRCs) that are hallmarked by DNA mismatch repair deficiency (dMMR). Testing tumors for dMMR has been advocated as a screening test for LS. Patients suspected to have LS based on screening will then undergo genetic counseling, confirmatory germline genetic testing, and specialized clinical genetics follow-up. We examined the decision associated with completion vs. non-completion of this 3-component clinical pathway among patients suspected to have LS.

Methods

During 2009-2014, a prospective protocol of universal LS screening tested 1597 consecutive CRCs for MMR status. dMMR CRC was determined by MSI testing and/or immunohistochemistry (IHC). A standardized follow-up clinical pathway was established for patients with dMMR CRCs and included 3 components: 1) genetic counseling at the point of care, 2) confirmatory germline genetic testing, and 3) enrollment in the Familial High-risk Clinic. Clinical and sociodemographic factors were examined to identify risk factors associated with the decision to complete vs. not complete all components of the follow-up clinical pathway.

Results

110 patients with dMMR CRCs were suspected to have LS. The treating physicians triggered a referral to genetic counseling in each and every case. Eighty-five (77%) of the referred patients completed genetic counseling, while 25 (23%) did not. Non-completion of this component of follow-up was associated with older age at CRC diagnosis (58 vs. 49 years, median; $p=0.03$), and not having private insurance (44% vs. 22%; $p=0.024$; 36% of the non-completion patients had Medicare). Among 85 patients who participated in genetic counseling, 75 (88%) completed the recommended confirmatory germline genetic testing, and 62 (83%) of the tested enrolled in the Familial High-risk Clinic. Similarly, non-completion of these two components was associated with older age (55 vs. 49 years, median; $p=0.01$) and lack of private insurance (48% vs. 27%; $p=0.036$).

Conclusion

The 3-component follow-up clinical pathway was associated with varying completion rates. It was lowest for genetic counseling, a decision triggered solely by the treating physicians, and highest for confirmatory genetic testing, a decision following genetic counseling. Aligning each care component with joint decision processes that involves both the patient and physician will likely increase follow-up, empower decision-making, and improve resource utilization.

OC226 - UNIVERSAL GENE PANEL TESTING OF PANCREATIC CANCER CASES FOR BREAST AND COLORECTAL CANCER SUSCEPTIBILITY GENES

B. Thompson¹, E. Young¹, M. Firpo², S. Mulvihill³, T. Werner¹, R. Bell¹, K. Smith¹, J. Berger¹, A. Fraser¹, L. Neumeier⁴, D. Goldgar⁵, W. Kohlmann¹, S. Tavtigian¹

¹Huntsman Cancer Institute Salt Lake City, ²Department of Surgery, University of Utah Salt Lake City, ³Research and Development Service, George E. Wahlen Department of Veterans Affairs Medical Center Salt Lake City, ⁴Department of Surgery and Arizona Cancer Center Tucson, ⁵Department of Dermatology, University of Utah Salt Lake City

Genes associated with hereditary breast and ovarian cancer (HBOC) and colorectal cancer (CRC) susceptibility are known to play a role in pancreatic cancer susceptibility. Pancreatic cancer is still lacking adequate measures for prevention or early stage tumor detection. Germline genetic testing will be most beneficial for at-risk relatives of pancreatic cancer cases with pathogenic variants in established HBOC and CRC genes, but it is unclear what proportion of pancreatic cancer cases harbor pathogenic variants in those genes.

In an initial experiment, 66 pancreatic cancer cases diagnosed at the Huntsman Cancer Hospital (HCH), SLC, UT, unselected for age of onset or family history, were sequenced using a custom 34 gene panel including known HBOC and CRC genes. The proportion of cases with a pathogenic gene variant was estimated probabilistically. Cases with an established pathogenic variant were assigned weight=1. Cases with a Variant of Uncertain Significance (VUS) in *BRCA1/2* or a mismatch repair gene were assigned a weight equal to the VUSs probability of pathogenicity from curated publicly available databases. Carriers of VUS from other genes were assigned a weight from Align-GVGD, CADD, Polyphen-2, and MAPP scores. We found that 8.5% of these cases carried a pathogenic variant.

To refine the carrier frequency estimate for unselected pancreatic cancer cases, a meta-analysis was conducted using the initial set, a second set from HCH (n=95), the Cancer Genome Atlas (TCGA) cohort (n=154), and a published dataset from a similar screen of unselected patients (n=96). These were compared to the non-TCGA Exome Aggregation Consortium (ExAC) dataset, using Standardized Incidence Ratios (SIR).

Overall, 10% of unselected pancreatic cancer cases carried a variant (including weighted VUS) in known HBOC and CRC susceptibility genes, that would alter the screening recommendations for at-risk relatives. High-risk genes contributed 5% (SIR 2.7, p<0.001), and moderate-risk breast cancer genes contributed 5% (SIR 2.5, p<0.001).

We conclude that the frequency of mutation carriers among unselected pancreatic cancer cases is high enough to rationalize applying genetic panel tests that include both HBOC and CRC susceptibility genes to all newly diagnosed pancreatic cancer cases. Only 2 of 10 carriers from HCH met criteria for genetic testing. This could further benefit at-risk relatives with cascade testing of healthy relatives for increased HBOC and CRC surveillance measures.

OC231- PATTERNS OF POLYP HISTOLOGY: PREDICTORS OF PERIL IN THE MUCOSA

M. Dean¹, J. Church¹

¹*Cleveland Clinic Digestive Disease Colorectal Department Cleveland*

Background:

Carcinogenesis is a multistep process, involving the accumulation of inherited and acquired genetic alterations that cause mucosal instability leading to premalignant polyps and eventually cancers. Precursor colonic polyps of varied subtypes correlate with the known neoplastic pathways. Adenomas are reflective of mutant APC, and correlate with chromosomal instability or mismatch repair pathways; sessile serrated adenoma/polyps (SSAP) arise on a background of KRAS/BRAF mutation and correlate with the CpG island methylator pathway, and left sided hyperplastic polyps (HP) are predominantly associated with KRAS mutation.

When patients present with premalignant polyps of multiple histology, multiple genetic mechanisms may be active, resulting in a more unstable, tumorigenic mucosa. We hypothesized that patients with a combination of SSAP, hyperplastic and adenomas would be at higher risk of developing dysplasia/cancer due to the synergistic effect of multiple active carcinogenic pathways.

Methods:

A prospective colonoscopy database was examined for patients with a history of SSAP. Medical chart review was performed to confirm and expand the data. Patients were grouped based on patterns of polyp histology: 1) only SSAP 2) SSAP + HP 3) SSAP + adenomas 4) SSAP + HP + adenomas. These 4 groups were compared in terms of the numbers, size, location and histology of polyps and either personal or family history of colorectal cancer. Data on age, smoking habits and BMI were also collected.

Results:

374 patients had SSAP. Average age was 70 years (range 21-88), and 43% were male. 156 (46%) patients were overweight, and 80 (24%) were obese. The most aggressive pattern of colorectal polyps was group 4 (SSAP + HP + adenoma) (see table). This pattern is associated with larger SSAP, more villous architecture in the adenomas, and most of the high grade dysplasia in both types of polyps. It is also associated with more multiplicity of both SSAP and adenomas. None of the SSAP existing in the absence of adenomas had cytological dysplasia. Other notable findings included the increased proportion of men in groups with adenomas, the role of smoking in the combination of SSAP, adenoma and hyperplastic polyp, and the personal history of cancer in the adenoma groups.

Conclusion:

The combination of SSAP, hyperplastic polyp and adenomas in the colorectal epithelium is a marker for aggressive carcinogenesis and underlines the importance of more frequent surveillance, accurate polyp detection and effective polyp removal.

OC233 - BIALLELIC NTHL1 MUTATIONS PREDISPOSE TO A BROAD VARIETY OF TUMORS WITH A UNIQUE SOMATIC MUTATIONAL SIGNATURE

R. de Voer¹, J. Grolleman¹, R. Weren¹, R. Kuiper¹, M. Nielsen², F. Elsayed³, M. Ligtenberg¹, K. Neveling¹, I. Rost⁴, D. Schindler⁴, A. Dimovski⁵, T. van Wezel³, N. Hoogerbrugge¹, R. Kuiper¹

¹Human Genetics Nijmegen, ²Clinical Genetics Leiden, ³Pathology Leiden, ⁴Human Genetics WÄ¼rzburg, ⁵Faculty of Pharmacy Skopje

Biallelic germline mutations affecting the base excision repair gene *NTHL1* predispose to the development of adenomatous polyposis and colorectal cancer. However, the clinical characteristics of previously identified *NTHL1* mutation carriers ($n=10$) suggest that *NTHL1* defects are also associated with extracolonic malignancies. Characterization of the somatic mutation spectrum in multiple colorectal carcinomas and a bladder cancer derived from individuals with biallelic germline *NTHL1* mutations revealed a bias towards C:G>T:A (C>T) transitions. Yet, a unique mutational signature, i.e. the combined set of mutation types generated by a single biological process, associated with *NTHL1* deficiency has not been described. Here, we explored the somatic mutation profile in five different malignancies derived from three individuals with biallelic *NTHL1* mutations and identified a distinct mutational signature. We identified three novel families in which biallelic *NTHL1* mutation carriers were diagnosed with multiple tumor types. We selected six malignancies from four different tissues (colon ($n=3$), thyroid-gland, urothelium, and tonsil) in order to determine the somatic mutation profile. A bias towards C>T mutations was confirmed in all tissue types. Furthermore, in all four tissue types a strong bias was observed towards C>T mutations at non-CpG sites, which is clearly distinct from sporadic cancers that show a bias towards C>T mutations at CpG sites caused by deamination of methylated cytosines. Interestingly, all six malignancies had a distinct somatic mutational signature in common. These results demonstrate that *NTHL1* deficiency is associated with a unique signature characterized by C>T mutations at non-CpG sites, and confirms the broad tumor spectrum associated with biallelic *NTHL1* mutation carriers. This finding provides an interesting strategy to establish whether a specific tumor is caused by a biallelic germline *NTHL1* mutation.

OC234 - RNF43 IN SERRATED POLYPOSIS AND SERRATED POLYPS

Y. van Herwaarden¹, L. Koggel¹, J. Salomon¹, E. Vink-BÃ¶rger², J. Dijkstra², P. Dura¹, N. Hoogerbrugge³, F. Nagengast¹, T. Bisseling¹, I. Nagtegaal²

¹Department of Gastroenterology and Hepatology Nijmegen, ²Department of Pathology Nijmegen, ³Department of Human Genetics Nijmegen

Background

Colorectal polyposis is strongly associated with a heritable genetic predisposition and an increased risk of colorectal cancer (CRC). Serrated polyposis syndrome (SPS) is a specific polyposis syndrome that is characterized by presence of multiple serrated polyps. Two recent whole-exome sequencing studies propose the ring finger protein 43 (RNF43) gene as a novel candidate gene for SPS.

Aims

Our primary aim is to test whether RNF43 germline mutations are present in SPS patients. Our secondary aim is to determine the presence of somatic RNF43 mutations in serrated colorectal lesions and whether presence of mutations is specific to one of the histological SP subtypes.

Methods

We tested germline DNA of SPS patients for mutations in RNF43 using PCR and Sanger sequencing. In order to investigate the role of RNF43 in non-syndromal serrated polyps we collected polyp DNA from all three serrated polyp subtypes. We performed PCR and Sanger sequencing on polyp DNA for two RNF43 hotspots in CRC (p.Arg117fs and p.Gly659fs). Microsatellite instability was assessed using immunohistochemistry and a panel of microsatellite markers.

Results

We included 25 SPS patients, of which 48.0% were female (n=12). Total polyp counts varied from 1-68, with SP count ranging from 1-67 and AD count ranging from 0-18 per patient. We discovered no truncating germline RNF43 mutations in our clearly phenotyped cohort of SPS patients.

We tested 25 sporadic hyperplastic polyps, 35 sessile serrated lesions and 38 traditional serrated adenomas. We detected RNF43 deleterious frameshift mutations only in 3 TSA (7.5%) and none in the other SP subtypes. After MSI status testing, 6.1% were MSI, including all RNF43 mutated TSA.

Conclusion

In conclusion, truncating germline RNF43 mutations are not common in SPS patients. Somatic frameshift mutations are likely to occur in SP only after acquisition of MSI.

OC239 - LINKAGE ANALYSIS IN FAMILIAL NON-LYNCH SYNDROME COLORECTAL CANCER FAMILIES FROM SWEDEN

M. Gonn¹, A. Backman¹, J. Björk¹, J. Thutkawkorapin², K. Wallander², A. Lindblom²

¹Institution of Medicine, Solna, Karolinska Institutet Stockholm, ²Institution for molecular medicine and surgery, Karolinska Institutet Stockholm

Background:

Recent studies have confirmed that family history is an important factor which influences the colorectal cancer risk. It is estimated that approximately 35 % of CRCs have a potentially identifiable genetic cause. Among many genetic causes the monogenic diseases FAP and HNPCC is considered the most well-known explaining only 5 %. By studying the pathogenesis of colorectal cancer, the significance of polyps as precancerous lesions has been discovered which has had a major impact in clinical practice and in the work of preventing development of colorectal cancer.

The aim of this study was to survey how genetics influence the origin of polyps and in the extension colorectal cancer.

Method: A linkage analysis was performed in 121 Swedish familial (600 individuals) non-lynch syndrome colorectal cancer families. The individuals were considered having an increased risk of developing polyps/colorectal cancer since they all had at least one first degree relative with colorectal cancer. The size of the families varied. All of them underwent genotyping and any mendelian inconsistencies were checked with PEDCHECK and MERLIN. Several analyses were made with the aim of finding a linkage between a possible gene and the polyps, both for recessive and dominant mode of inheritance. Patients in the study were considered as "affected" when endoscopic examination found polyps of various histology except hyperplastic ones.

Results: The linkage analysis provided HLOD/LOD score above 2 for several areas suggestive of linkage. The preliminary results of the study found support for 4p16.3(LOD 2,3), 4q34.3(HLOD 1,94), 6p24.3(LOD 2,2), 10p14 (HLOD 2,12) possibly being involved in the development of polyps.

Conclusion: Several candidate genes were observed in the loci mentioned with properties which supposedly have an involvement in cell proliferation. DNA sequencing was performed for the areas mentioned. 4p16.3 and 10p14 have been mentioned in previous colorectal cancer studies.

OC242 - THE INSIGHT INDEX: A NOVEL METRIC DESIGNED TO ADVANCE THE MISSION & GOALS OF INSIGHT

T. Weber MD¹, I. Frayling MA MB BChir PhD², D. Ahnen MD³, P. Schroy MD MPH⁴, D. Alsina MBE⁵, S. Shraga MD¹, K. A. Mccullagh BA⁶, K. McNamara MD¹, C. Borassi BA⁷

¹Department of Surgery and Center for Genomic Health, State University of New York Health Sciences Center NY, NY, USA, ²Institute of Medical Genetics, University Hospital of Wales Cardiff, UK, ³University of Colorado Cancer Center Denver, Colorado USA, ⁴Boston University School of Medicine Boston, MA, USA, ⁵Bowel Cancer UK London, UK, ⁶Pennsylvania State University College of Medicine Hershey, PA, USA, ⁷Colon Cancer Challenge Foundation White Plains, NY, USA

Introduction: Fundamental to the InSiGHT mission; “To improve the quality of care of patients and families with any hereditary condition resulting in gastrointestinal tumours”¹ is the identification of carriers of relevant predisposition alleles. The purpose of this study is to explore the progress of select national healthcare systems in reducing MMR associated hereditary colorectal cancer mortality. In addition, a novel metric designed to focus attention and resources on securing InSiGHT’s mission and goals is proposed.

Methods: PUB MED and WHO GLOBCAN data were searched for published information on the following parameters: 1. Current estimates of the number of MMR gene carriers 2. National policies and efficacy of efforts to secure family health history information 3. Current status of national programs to test index CRC tumors for MMR proficiency and 4. Stage at CRC diagnosis of MMR allele carriers.

Results: Current literature indicates estimates of the number of carriers of MMR gene alterations associated with CRC incidence have significant limitations. Estimates range from 1-1.7 million carriers in the European Union; 700,000 - 1.2 million in the US and potentially 18 million worldwide.^{2,3,4} The vast majority unrecognized.⁴ Family Health History (FHH) documentation and access to “reflex” testing of CRC tumors for MMR status in the US remains limited for the majority of the population.^{5,6} Current literature suggests FHH documentation in Europe is also inconsistent.³ Stage at CRC diagnosis for MMR gene carriers in the US at a population level is unknown because US national cancer registries (CDC & NCI) collect neither FHH nor germline DNA data.⁷ Similar national cancer database limitations exist in Europe however the success of multiple European Union member states in interrogating ever increasing percentages of CRCs for MMR status is improving the identification of carriers^{8,9}.

Conclusions: Current literature indicates prior recommendations of Founding Members of InSiGHT to pursue both family health history as well as tumour MMR status as a strategy to identify and protect MMR gene mutation carriers face limited implementation in Europe³ and the US^{5,6}. We propose the InSiGHT Index [Number of MMR carriers identified/Number of MMR Carriers Estimated (in a given health care system)] provides a simple metric that focuses attention on and clarifies progress towards InSiGHT’s Mission and MMR associated cancer control goals.

1. <https://www.insight-group.org>
2. Vasen HFA et al. Recommendations to improve identification of hereditary and familial colorectal cancer across Europe. *Familial Cancer* 2010 9:109-115
3. Van Erp SJH et al. Identification of familial colorectal cancer and hereditary colorectal cancer syndromes through the Dutch population-screening program: results of a pilot study. *Scandinavian Journal of Gastroenterology* 2016 51:1227-1232
4. Win AK et al. Prevalence and penetrance of major genes and polygenes for colorectal cancer. *Cancer Epi, Biomarkers & Prevention* 31 October 2016
5. Lowery JT, Weber TK et al. Understanding the contribution of family history to colorectal cancer risk and its clinical implications: A state-of-the-science review. *Cancer* 1 September 2016 2633-45
6. Karlitz JJ et al. Population-Based Lynch Syndrome Screening by Microsatellite Instability in Patients ≤ 50 . *American Journal of Gastroenterology* 2015 110: 948-955

7. <https://seer.cancer.gov/data>
8. <http://globocan.iarc.fr/Default.aspx>
9. 2016 Data Briefing: Reflex testing for Lynch syndrome in people diagnosed with bowel cancer under the age of 50. Royal College of Pathologists and Bowel Cancer U.K. <https://www.bowelcanceruk.org.uk/research/>

OC244 - IMPROVEMENT OF LYNCH SYNDROME DIAGNOSTICS BY NGS BASED TUMOR MMR GENE ANALYSIS: RESULTS OF 3 PECULIAR CASES

W. N.M. Dinjens¹, W. R.R. Geurts-Giele¹, I. C. Meijssen¹, A. Wagner², H. J. Dubbink¹

¹Departments of Pathology, Erasmus MC Cancer Institute CA Rotterdam, The Netherlands, ²Departments of Clinical Genetics, Erasmus MC Cancer Institute CA Rotterdam, The Netherlands

Introduction.

Lynch syndrome (LS) is caused by germline mutations in mismatch repair (MMR) genes, resulting in microsatellite-unstable tumors. Approximately 35% of suspected LS (sLS) patients test negative for germline MMR gene mutations, hampering conclusive LS diagnosis.

Recently, we (Geurts-Giele et al., *J Pathol*, 2014;234:548-59) and others (Mensenkamp et al., *Gastroenterology*, 2014;146:643-6 and Haraldsdottir et al., *Gastroenterology*, 2014;147:1308-16) have demonstrated that about 50% of the sLS patients without identified MMR gene germline mutation are caused by the combination of two somatic mutations in one of the MMR genes. As a consequence, these patients and their family members can be released from surveillance. Therefore we included in our routine combined clinical genetics and pathology molecular diagnostics tumor MMR gene next generation sequencing (NGS) and additional analyses on indicated cases.

Case description.

Case 1. Female, 76 years, colorectal carcinoma, MSI positive, absence of protein expression of MSH2 and MSH6. Germline MMR gene analysis: no pathogenic mutation identified.

Case 2. Female, 49 years, colorectal carcinoma, MSI positive, absence of protein expression of MSH2 and MSH6. Germline MMR gene analysis: no pathogenic mutation identified.

Case 3. Male, 49 years, colorectal carcinoma, MSI positive, absence of expression of MLH1 and PMS2, no hypermethylation of the MLH1 gene promoter by Methylation-Specific Multiplex Ligase-dependent Probe Amplification (MLPA).

Materials and Methods.

The tumors from all 3 cases were investigated in our routine pathology molecular diagnostics laboratory by a custom made MMR gene NGS panel for analysis on the Ion Torrent PGM. To detect allelic imbalances of the MMR genes this custom made NGS panel is supplemented with Single Nucleotide Polymorphism (SNP) amplicons (Dubbink et al., *J Mol Diagn*, 2016;18:775-86). In addition, MMR gene Multiplex Ligase-dependent Probe Amplification (MLPA), MMR gene Fluorescence In Situ Hybridization (FISH) and BerEp4 immunohistochemistry were performed.

Results.

In all 3 cases somatic homozygous deletions in the indicated genes were identified by multiple investigations.

Conclusion.

These results demonstrate that in sLS patients somatic mutation analysis of MMR genes in the tumors should be complemented with analyses able to detect somatic homozygous deletions in these genes.

PP01 - THE ASSOCIATION OF LOW PENETRANCE VARIANTS IN DNA REPAIR GENES WITH COLORECTAL CANCER: A SYSTEMATIC REVIEW AND META-ANALYSIS

N. Aggarwal¹, N. Donald¹, S. Malik¹, S. Selvendran¹, M. McPhail¹, K. Monahan²

¹Imperial College London London, ²Family History of Bowel Cancer Clinic, West Middlesex University Hospital, Chelsea and Westminster Hospitals NHS Trust London

Introduction

Approximately 35% of colorectal cancer (CRC) risk is attributable to heritable factors, with known hereditary syndromes accounting for 6% of the total. The remainder may be largely due to lower penetrance genetic risk factors in genes including those, which control DNA replication and repair. Complex evolutionary conserved DNA repair pathways include Base Excision Repair (BER), Nucleotide Excision Repair (NER), Mismatch Repair (MMR), Direct Reversal Repair (DRR) and Double-Strand Break (DSB) repair. These pathways are critical in carcinogenesis. Repair and replication gene mutations occur in over 58% of cancer cell lines and germline mutations in these DNA repair genes are associated with known high penetrance CRC syndromes including Lynch syndrome and many polyposis syndromes. However, the association of low penetrance polymorphisms of DNA repair genes with CRC risk is unclear.

Methods

A systematic literature review of PubMed and HuGENet databases was conducted. Studies were included/excluded based on pre-specified criteria. Per-allele, pooled odds ratio calculations disclosed the risk attributed to each individual variant. Heterogeneity was investigated by subgroup analyses for ethnicity and tumour location; funnel plots and Egger's test assessed any publication bias.

Results

Sixty-one polymorphisms in 26 different DNA repair genes were identified. Meta-analyses for 22 of these polymorphisms in 17 genes, with 1706 to 9682 CRC cases per polymorphism, revealed 6 polymorphisms were significantly associated with CRC risk within BER (*APE1*, *PARP1*), NER (*ERCC5*, *XPC*), DSB (*RAD18*), and DRR (*MGMT*), but none within the MMR pathway. Subgroup analyses revealed significant association of *OGG1* rs1052133 with rectal cancer risk. Egger's test revealed publication bias was not a source of heterogeneity.

Conclusion

Low penetrance polymorphisms in highly conserved DNA repair genes alter susceptibility to CRC. Knowledge of which DNA repair gene polymorphisms are associated with CRC risk may allow a better understanding of global risk and facilitate personalised CRC risk assessment.

PP02 - MDM2 T309G POLYMORPHISM AND RISK OF COLORECTAL CANCER

N. Aggarwal¹, N. Donald¹, S. Malik¹, S. Selvendran¹, M. McPhail¹, K. Monahan²

¹Imperial college London London, ²Family History of Bowel Cancer Clinic, West Middlesex University Hospital, Chelsea and Westminster Hospitals NHS Trust London

Background

Murine double minute 2 (MDM2) is an E3 ubiquitin-protein ligase that mediates cell cycle arrest by negatively regulating the tumour suppressor gene p53. Polymorphisms have been thought to be associated with colorectal cancer (CRC), however results have been largely inconclusive. A meta-analysis of MDM2 T309G (rs2279744) was conducted to clarify and assess whether any association could be found.

Methods

A systematic literature review of the Pubmed and HuGENet databases was conducted and studies were included/excluded based on pre-specified criteria. The per allele model was used to assess risk by calculating pooled odds ratios with 95% confidence intervals. Publication bias was investigated using a funnel plot. Statistical analysis was conducted using the R program (version 3.2.4).

Results

A total of 135 studies were screened and 6 case control studies were included with 3553 cases and 5781 controls. No association was found between MDM2 T309G and CRC (OR= 1.25; 95% CI 0.97-1.62). The funnel plot showed that publication bias was present.

Conclusion

This meta-analysis suggests that MDM2 T309G polymorphism is not associated with risk of CRC and should not be evaluated as part of a patient risk assessment. Future studies with larger and more varied ethnicities would allow more accurate assessment of the association between MDM2 T390G and CRC risk.

PP05 - YOUR INSIGHT

J. Hawkins¹, S. Clark¹

¹*InSiGHT Secretariat Harrow*

Introduction

The biennial meeting is an opportunity for InSiGHT Council and members to meet, and for members to find out more about and contribute to their society, and its activities.

Aim

To provide information on the membership and activities of InSiGHT, its Council and secretariat since the last meeting.

Methods

Data were obtained from the InSiGHT membership database, minutes of Council meetings and Google Analytics.

Results

During the period 2015-2016 there were 182 fully paid up members of InSiGHT (126 MDs) and 6 honorary life members. The breakdown by country was: Argentina 5, Australia 16, Austria 2, Brazil 17, Canada 4, Chile 1, China 4, Colombia 2, Denmark 8, Finland 2, Germany 10, Ireland 2, Israel 2, Italy 5, Japan 7, Kuwait 1, Malaysia 1, New Zealand 5, Norway 4, Peru 2, Spain 5, Sweden 7, Switzerland 1, The Netherlands 13, UK 21, Uruguay 1, USA 34. Members are currently registering for 2017 -2018 on the new InSiGHT website platform.

Details of current Council members and their roles will be presented, along with information on how to stand. The voting system for Council has been updated to allow voting by e-mail, allowing members who cannot attend the meeting to remain engaged.

A new website, e-mail system and membership management platform were launched on 1 Oct 2016. Free electronic access to Familial Cancer is now available to all members.

In the period from launch to 10 Dec 2016 there were 5700 hits, 54% new. On average 2.94 pages were viewed per visit, which had an average duration of 2 minutes. Visitors to the site were from 84 countries, the most being from the USA, followed by UK, Spain, Australia, Italy and Japan.

Kay Neale has retired, and the secretariat is now comprised of Jackie Hawkins and Sue Clark.

Conclusion

InSiGHT continues to have a broad international audience, membership and Council, and welcomes new members. The new website has facilitated this.

PP06 - WORKING WITH CLINICIANS TO IDENTIFY BARRIERS TO FAMILY CANCER CLINIC REFERRALS FOR PATIENTS AT HIGH RISK OF LYNCH SYNDROME

R. Williams¹, J. Long², D. Debono², M. Chin³, N. Taylor²

¹Hereditary Cancer Clinic, Prince of Wales Hospital Sydney, Australia, ²Australian Institute of Health Innovation, Faculty of Medicine and Health, Macquarie University Sydney, Australia, ³Medical Oncology, Prince of Wales Hospital Sydney, Australia

Background: Referral rates to Family Cancer Clinics (FCC) for patients at high risk of Lynch syndrome are known to be low from a number of studies. This study examined barriers to referral at two large, Australian hospitals. We focused on patients being treated surgically for colorectal cancer who have possible Lynch syndrome flagged in their tumour pathology results (mismatch repair deficient immunohistochemistry).

Methods: We used the Theoretical Domains Framework Implementation (TDFI) approach, a validated six-step process for changing clinical practice based on behaviour change theory. We established two multidisciplinary implementation teams (n=8 at Hospital A, n=11 at Hospital B) to process map current practice. A 12-month retrospective audit showed referral rates of 36% and 13% at Hospital A and B respectively.

We report here on barriers to referral drawn from a number of different sources. (1) Minutes from four Implementation Team meetings. (2) Audit data. (3) The validated *Influences of Patient Safety Behaviour Questionnaire (IPSBQ)* which was distributed to 71 health professionals involved in the management of patients with colorectal cancer. The *IPSBQ* allows barriers to referral to be classified according to behaviour change domains and was tailored to our setting by a genetics counsellor, a medical oncologist and health services researchers. (4) Multidisciplinary focus groups and interviews (n=19) held to discuss the questionnaire findings.

Results: All four data sources highlighted barriers in the ‘environmental context and resources’ domain. Clinicians spoke of problems finding referral forms, being unable to track referrals, and suboptimal timing of pathology reports in relation to follow up. Another significant barrier was in the domain ‘cognitive processes, memory and decision making.’ Confusing terminology on pathology reports hindered decision making; lack of a structured process (such as a pro forma) in case conferences or consults made genetic screening more likely to be overlooked. We found ‘skills’ was a significant barrier in the questionnaire.

Discussion: Input from all stakeholders: pathologists, surgeons, oncologists and genetic cancer services (departments often labelled as “silos”) and triangulated data collection enabled a comprehensive approach to the problem of low referral rates. While some barriers were mentioned often (elusive referral forms), others such as ‘skills’ was revealed as a significant barrier in the questionnaire only. Focus groups confirmed lack of training as an issue for junior rotating medical officers, and suggested it may be an unacknowledged issue for more senior surgeons also.

Understanding barriers in terms of how they impede behaviour change means we can co-design strategies to address them using matched behaviour change techniques. Regular audits will continue so we can assess changes in the referral rate.

PP08 - RUPTURE OF SUPERIOR MESENTERIC ARTERY ANEURYSM IN DESMOID PATIENTS

X. xhaja¹, J. church¹

¹colorectal surgery cleveland

Patient	Gender	Age at diagnosis of desmoid disease	Symptoms of Aneurysm	Presentation and treatment	Outcome
1	M	24	Back pain	Acute rupture Endovascular stent	Continued bleeding, expired
2	F	35	Liquefaction of desmoid showed aneurysm on CT scan	Acute rupture Endovascular st	Ischemic pouch, enterocutaneous fistula, repaired. Pouch recovered
3	F	23	Back pain		

Introduction

Rupture of a superior mesenteric aneurysm (SMA) is a rare but potentially lethal complication in patients with familial adenomatous polyposis and desmoid disease. We have cared for three patients with this complication and report our experience to emphasize its lethality.

Methods

We reviewed the patients with mesenteric desmoid tumors in our desmoid registry. Out of 135 patients with mesenteric desmoid disease there were three cases of rupture of SMA aneurysm in the setting of growing desmoid tumors. These cases are described here.

Results

The three cases are summarized in the table. Patients 1 and 3 had undergone total proctocolectomy for their polyposis and patient 2 had an ileorectal anastomosis. Two of the patients had Stage IV desmoid disease and the other stage III. Each of them had chemotherapy as part of the treatment. The time from age of diagnosis of desmoid disease to diagnosis of the aneurysm was 62 months, 11 months and 130 months for patients 1, 2 and 3.

Each of the patients was critically ill as a result of complicated of the aneurysm and one patient died. Patients 2 and 3 ruptured acutely and needed emergency treatment to control the rupture.

Conclusion

SMA is an uncommon but potentially lethal condition on mesenteric desmoid tumors in FAP.

Diagnosis of an SMA aneurysm in such patients should prompt urgent referral to vascular surgery.

PP15 - BONE MARROW TRANSPLANT AND GENETIC TESTING

P. McGinty¹, S. Clark¹

¹The Polyposis Registry London

~~Bone marrow transplant and genetic testing - an increasing clinical problem

Patricia McGinty and Sue Clark

The Polyposis Registry, St Mark's Hospital

Introduction

Diagnostic genetic testing is routinely performed on patients with suspected Lynch or polyposis syndromes, and predictive testing is offered to at risk relatives of affected individuals.

Bone marrow transplantation is increasingly used in the treatment of haematological malignancy, with improving survival rates. This has resulted in an expansion in the number of bone marrow transplant recipients. Such individuals have undergone ablation of bone marrow, which is replaced by donor cells, so that blood leucocytes are donor derived. These donor cells are also present in other tissues such as buccal mucosa, and therefore some DNA derived from these sources originates from the bone marrow donor, rather than the individual undergoing genetic testing.

We describe two cases in which this problem arose.

Case 1

A 35 year old male was referred with a possible clinical diagnosis of Juvenile Polyposis Syndrome. Genetic testing done from a blood sample yielded female DNA, and on further investigation it transpired that the subject had undergone a bone marrow transplant for leukaemia in childhood. A buccal scrape was then performed, but the resulting DNA was 70% donor derived, and testing could not therefore be undertaken. On discussion with the patient he is currently undergoing clinical follow-up only.

Case 2

A 38 year old male was referred with oligoadenomatous polyposis. He underwent chemo radiotherapy as a child for Acute Lymphocytic Leukaemia and received a bone marrow transplant from his brother.

Because of this he was referred to a Consultant Clinical Geneticist who is seeing him in order to perform a skin biopsy from which DNA extraction and genetic testing will be performed.

In addition, we contacted the lead of the largest bone marrow transplant centre in the UK, to discuss their approach to this issue. It is not routine for such transplant recipients to be warned about the resulting issues with regard to genetic testing.

Conclusion

Clinicians and genetic counsellors undertaking genetic testing should be aware that standard genetic testing is likely to be erroneous if an individual has undergone bone marrow transplantation, and alternative sources of DNA, such as skin biopsy, are needed.

PP17 - PREVALENCE OF LYNCH SYNDROME AND LYNCH-LIKE SYNDROME AMONG PATIENTS WITH COLORECTAL CANCER IN A JAPANESE HOSPITAL-BASED POPULATION

H. Eguchi¹, N. Chika², K. Kumamoto², O. Suzuki², K. Ishibashi², T. Tachikawa³, K. Akagi³, J. Tamaru⁴, Y. Okazaki¹, H. Ishida²
¹Division of Translational Research, Research Center for Genomic Medicine, Saitama Medical University Hidaka, ²Department of Digestive Tract and General Surgery, Saitama Medical Center, Saitama Medical University Kawagoe, ³Division of Molecular Diagnosis and Cancer Prevention, Saitama Cancer Center Ina, ⁴Department of Pathology, Saitama Medical Center, Saitama Medical University Kawagoe

[Objective] We investigated the prevalence of Lynch syndrome (LS) and Lynch-like syndrome (LLS) among Japanese colorectal cancer patients, as there have been no credible data from Japan.

[Methods] Immunohistochemical (IHC) analyses for mismatch repair (MMR) proteins (MLH1, MSH2, MSH6 and PMS2) were carried out in surgically resected, formalin-fixed paraffin-embedded specimens obtained from 1,234 newly diagnosed colorectal cancer patients between March 2005 and April 2014. The presence/absence of the *BRAF* V600E mutation and hypermethylation of the *MLH1* promoter was analyzed where necessary. Genetic testing with Sanger sequencing and MLPA analysis was finally undertaken in patients suspected as having LS. Somatic mutation analyses were also conducted to identify LLS for those without pathogenic germline mutation.

[Results] By the universal screening approach with IHC analysis for MMR proteins followed by analyses for the *BRAF* V600E mutation and *MLH1* promoter methylation status, 11 of the 1,234 patients were identified as candidates for genetic testing. Out of the 11 patients, 9 were finally diagnosed as having LS; the responsible genes included *MLH1* (n = 1), *MSH2* (n = 4), *EPCAM* (n = 1) and *MSH6* (n = 3). Notably, the LS patient with *MLH1* loss showed a heterogeneously methylated *MLH1* promoter in the tumor. There was no possibility to suspect the presence of germline *MLH1* epimutation among those with *MLH1*/*PMS2* loss. The incidence of LS among unselected newly diagnosed CRC patients was 0.7%, which might be lower than that reported previously (1–5%), but within the same range (0.7–3.7%) as that reported by recent studies, mainly from Western countries, based on a universal screening approach of all newly diagnosed patients of CRC. The remaining two patients (0.2%) were regarded as having LLS, since biallelic somatic deletion of the relevant mismatch repair genes was detected in the absence of germline mismatch repair alterations. The clinicopathologic factors related to LS/LLS, such as age of diagnosis, tumor location, differentiation and stage, were in concordance with those previously reported from Western countries. A selective screening approach based on the Bethesda guidelines would have missed 24% of LS patients.

[Conclusions] The prevalence of LS among all newly diagnosed cases of colorectal cancer in Japan is in the same range as that recently reported by studies in Western population. The prevalence of LLS seems to be extremely low.

PP19 - WHOLE TRANSCRIPTOME ANALYSIS IN EARLY-ONSET COLORECTAL CANCER AS AN EFFECTIVE METHOD TO IDENTIFY RESPONSIBLE GENE

K. Fujiyoshi¹, G. Yamamoto², M. Kakuta², T. Wakatsuki², Y. Arai², A. Takahashi², M. Kikuchi², M. Yamada², S. Kobayashi², T. Tachikawa², Y. Akagi¹, K. Akagi²

¹Department of Surgery, Kurume University Fukuoka, Japan, ²Division of Molecular Diagnosis and Cancer Prevention, Saitama Cancer Center Saitama, Japan

Background: Early-onset malignant tumors are supposed to have frequently genetic background. In recent study, some sort of pathogenic germline mutations were detected by 8.5% of patients affected malignant tumor under twenty years of age. Moreover, limiting to the colorectal cancer (CRC), 35% of the patients were diagnosed as hereditary colorectal cancer syndrome. These frequency in two studies was much higher than in the general population (1000Genome Project). Both of these studies indicated that substantial proportion of hereditary cancer syndrome were diagnosed in individuals with no family history and phenotypes of the disease. Consequently, some genetic approach (such as genetic test and counseling) was recommended for juveniles affected cancer.

Methods: Based on the background, 10 cases of early-onset (under 40 years of age) CRC without high-frequency microsatellite instability (MSI-H) was analyzed using whole transcriptome analysis.

Results: Compared to colon cancers with microsatellite stable (MSS), zinc finger protein family were expressed significantly higher (FDR adjusted p-value <0.05). In the pathway analysis, homologous recombination and mismatch repair related pathway were up-regulated and apoptosis related pathway was down-regulated. On the other hand, mutation in *TP53* were identified in 8 out of 10 cases, though no germline mutation in *TP53* was not found in these cases. Missense mutation in *DKC1* and *BMPRIA* was detected by RNA sequence and confirmed in germline sequencing. The missense mutation in *DKC1* was decided as pathogenic by the database and loss of heterozygosity (LOH) of *BMPRIA* was suggested that this missense mutation in *BMPRIA* was pathogenic. Responsible germline mutations were found in 2 cases among 10 of early-onset CRC.

Conclusion: Whole transcriptome analysis targeted to juvenile cancer patients regardless their background suggested to be effective method to reveal a cause of cancer.

PP20 - RISK FACTORS FOR ADVANCED DUODENAL AND AMPULLARY ADENOMATOSIS IN FAMILIAL ADENOMATOUS POLYPOSIS: A CLINICAL AND MOLECULAR PROSPECTIVE STUDY IN A BRAZILIAN POPULATION.

F. G. Campos¹, M. N. Sulbaran¹, U. Ribeiro Jr¹, R. D. A. Coudry², S. I. Meireles², B. C. G. Lisboa², H. S. Kishi³, P. Sakai¹, E. G. de Moura¹, L. A. Bustamante-Lopez¹, M. Tomitao¹, S. C. Nahas¹, I. Ceconello¹, A. Safatle-Ribeiro¹

¹Gastroenterology Department. Hospital das Clínicas, University of São Paulo Medical School, Brazil. Sao Paulo, ²Molecular pathology department, Sirio Libanes Hospital Sao Paulo, ³Pathology Department. Hospital das Clínicas, University of São Paulo Medical School, Brazil. Sao Paulo

Aim: To determine clinical and molecular characteristics associated with the development of advanced duodenal and ampullary adenomas in FAP.

Patients and Methods

This is a prospective, single referral center study of 62 Brazilian patients related to 46 families with Familial Adenomatous Polyposis (FAP). All patients underwent lateral and forward view gastroduodenoscopy. Duodenal polyposis was classified according to Spigelman. Balloon assisted enteroscopy was performed in patients Spigelman III and IV.

Non-ampullary duodenal polyposis was stratified into two groups: Spigelman O to II; and Spigelman III and IV. Additionally, patients were divided according to presence or not of ampullary adenomas. These groups were related to: gender, age, family history of FAP, type of colorectal surgery, and type of colorectal polyposis.

8 unrelated probands Spigelman III/IV and/or with ampullary adenomas underwent molecular testing for mutations in 94 genes and 284 polymorphisms (TruSight® Cancer-Illumina). Also, insertions and deletions in the APC, MLH1, MSH2 and PMS2 genes using the Ligation-dependent Probe Amplification Multiplex methodology were evaluated.

Results

Duodenal adenomatosis stage 0-II was detected in 49 patients, 79% (21 male/28 female, mean age 35.75±14.4 years), while advanced duodenal polyposis (Spigelman III or IV) was present in 13 patients, 21% (9 male/4 female, mean age of 37.61±13.9 years). There was statistically significant association between family history and groups according to Spigelman (p = 0.03). Patients with positive family history of FAP presented 6.67 lower risk for advanced duodenal polyposis according to logistic regression analysis. 7 unrelated patients presented ampullary adenomas (1 major and 6 minor adenomas, mean age 36.14±14.2 years). Association between ampullary adenomas and extraintestinal manifestations was statistically significant in multivariate analysis (p = 0.009).

A similar Spigelman score among different first-degree relatives from each family was demonstrated (Table 1). 10/12 patients who performed enteroscopy presented small tubular adenomas with low-grade dysplasia in proximal jejunum.

Conclusions

1. Advanced duodenal polyposis phenotype could be predictable upon disease severity of a first degree-relative; 2. Deletions in APC exon 15 were common in patients with advanced duodenal and/or ampullary disease; 3. There was an independent association between presence of ampullary adenomas and extraintestinal manifestations.

PP21 - MOLECULAR PROFILE OF FAMILIAL COLORECTAL CARCINOMA (CRC) IN COLOMBIA

M. Bohorquez¹, A. ESTRADA¹, A. CRIOLLO¹, M. ECHEVERRY¹, L. G. CARVAJAL CARMONA²

¹University of Tolima Ibague Colombia, ²Department of Biochemistry and molecular medicine, UC-DAVIS School of medicine DAVIS CALIFORNIA USA

Background and purpose: Colorectal carcinoma has a high rate of incidence and mortality. This Research describes some molecular phenotypes in a sample of 1278 patients. Variants of the mismatch repair (*MMR*) genes *MUTYH* and *APC* were evaluated in addition to other genes involved in hereditary syndromes.

Methods: Clinical criteria were applied to differentiate the hereditary carcinoma. Immunohistochemistry (IHC) was used to analyze the expression of the hMLH1 gene and somatic mutations were evaluated in tumor DNA. Genomic libraries were created using microfluidic gene chips (Fluidigm) and the MiSeq sequencing system (Illumina) was used for sequencing. Candidate variants were selected and validated by Sanger sequencing. The microsatellite instability was analyzed using PCR-FCE.

Results: Analysis of 574 cases using IHC-MLH1 showed loss of expression in 7.1% of the cases evaluated. MSI (microsatellite instability) analysis of 451 cases indicated a high value of MSI-H (22.6%). Analysis of 159 patients with familial CRC showed 48 mutations, 18 of which showed functional implications and three were founder *MSH2* mutations appearing in two and three individuals, respectively, the third c.596delTG .

According to the pathology reports, the average age is 57 years, with 29% of the cases being less than 50 years old. Locoregional metastasis was diagnosed in 75% of the patients. The most common location of the tumor was in the rectum (41%). The most common familial syndrome observed was the syndrome of Lynch with 85% of cases having *MSH2* mutations.

Conclusions:

Analysis of familial CRC indicated variants in the genes *APC*, *MSH2*, *MLH1* and *SMAD4*. The identification of gene variants with founder effect and the mutations in genes related to familial carcinoma will allow the establishment of preventative strategies by screening for mutations in the populations at risk. Screening using immunohistochemistry of *MLH1* and the determination of microsatellite instability allows the identification of patients with Lynch syndrome.

We have developed a low-cost, high-throughput pipeline, and method to screen 480 customizable amplicons (~20 genes, ~144Kbp) for up to 384 samples per run. By combining a bioinformatics pipeline to design customized screening panels with Fluidigm microfluidics PCR, Illumina MiSeq, and variant analysis pipelines.

This project was funded by European economic community, universities of Oxford, California and Tolima

PP24 - ATTENUATED FAP - HOW SHOULD IT BE DEFINED AND WHAT ARE THE CLINICAL OUTCOMES?Â

C. Anele¹, J. Chauhan¹, P. McGinty¹, I. Martin¹, F. Omar¹, A. Latchford¹, S. Clark²

¹The Polyposis Registry, St Mark's Hospital, Harrow, UK Department of Cancer and Surgery, Imperial College London, UK London,

²The Polyposis Registry, St Mark's Hospital, Harrow, UK Department of Cancer and Surgery, Imperial College London, UK London

Attenuated FAP (AFAP) is characterised by low number (<100) and delayed development of colorectal adenomas. Various definitions have been used, and genotype-phenotype correlations suggested. Using published criteria, we aim to assess the genotype, large bowel and duodenal phenotype of AFAP patients.

Method

Individuals with AFAP were identified from our registry. Phenotype was defined as adenomas <100 at age 25 years and genotype was defined according to previously published data. Only patients with a germline APC mutation were included in this study.

Pathology polyp count (PPC) was used for patients who had undergone surgery and endoscopic polyp count (EPC) for those with intact colon.

APC mutations were stratified into: attenuated (codon 1-159), pre-MCR (codon 160-1249), MCR (codon 1250-1450) and post-MCR (> 1450).

Results

Sixty-eight patients were identified with phenotypic AFAP. Of these 37 had undergone colectomy at median age 25 years (IQR 18-47). Thirty-four (89%) patients underwent colectomy with ileorectal anastomosis (IRA), three (8%) underwent restorative proctocolectomy (RPC) and one (3%) had sigmoid colectomy. Three (5%) patients had bowel cancer. The median PPC was 45.5 (IQR 14-83). Three (8%) patients had mutation in the AFAP region, 29 (76%) in the pre-MCR region and three (8%) in the post MCR region. Two (5%) had duplication of exon 4; one (3%) had a deletion of exon 7.

Thirty patients (median age 40 years [IQR 32-55]) had an intact colon. The median EPC was 38 (IQR 15-60). Eleven (35%) patients had mutation in the AFAP region, 8 (26%) in the pre-MCR region and 5 (16%) in the post MCR region. Three (10%) patients had mutation in intron 9 and 3 in intron 13.

Fifty-two patients had recorded Spigelman staging (Sp 0-IV) on OGD. At first OGD, 27 (52%), 13 (25%), 11 (21%) and one (2%) patients had Sp 0, I, II and III respectively. The highest Sp stage (at median age 39) was: Sp0 20 (38%), SpI 15 (27%), SpII 14 (27%), SpIII in 1(2%) and SpIV 3 (6%).

Sixty-four patients were identified with genotypic AFAP and had undergone colonic surgery at a median age of 28.5 years (IQR 18-42.5). Fifty-seven (89%) patients underwent IRA and 7 (11%) RPC. Five (8%) patients had PPC < 100, fifty-nine (92%) had polyp count >100.

Conclusions

Genotype cannot be used to define AFAP; germline mutation in AFAP is very variable. Duodenal disease severity does not appear to be milder in AFAP.

PP25 - WHAT ARE THE ADVANTAGES TO PAEDIATRIC CARE OF HAVING A PAEDIATRIC POLYPOSIS SERVICE?

J. Hawkins¹, K. Neale¹, S. Clark¹, W. Hyer¹

¹The Polyposis registry Harrow, united kingdom

~~What are the advantages to patient care of having a Paediatric Polyposis Service?

Jackie Hawkins, Kay Neale, Sue Clark and Warren Hyer

The Polyposis Registry, St Mark's Hospital

Purpose

The first Paediatric Polyposis Nurse Practitioner role at our institution was introduced in April 2014. This innovative post was initiated to enhance the patient experience, improve care and compliance with follow up and increase patient satisfaction. We have previously shown that patient satisfaction has been improved with the introduction of a transition sedation pathway for colonoscopy.

Methodology

This descriptive qualitative audit used an anonymised questionnaire and a prospective review of our patient database, to review these aspects. The questionnaire tool was based on the Likert scale and has previously been used in two different centres for chronic conditions and the questions have been adapted for this patient group. For a six month period between 30/10/2015 and 01/05/2016 data were collected prospectively, from all parents and children and adolescents / young people, with a confirmed diagnosis of a polyposis syndrome, who attended for surveillance and appointments. We looked at recall and attendance as a marker of quality during this period and compared these data to 2 years before the introduction of this role.

Results

In total 64 children attended during this time period and 57 questionnaires were given out:

34 Polyposis Service Review forms were given to parents.

23 Adolescent Service Review forms were given to children over 10 years of age.

52/57 - (91%) questionnaires were completed and returned, the return rate was the same in both groups.

Of the forms not completed – x 2 were not returned, x 2 were not completed because the family were happy with the service given and x 1 refused to complete.

52% of the children had been diagnosed since the implementation of this role. This quantifies the number of children seen in OPD and having surveillance procedures which has nearly doubled during this time.

This study has shown that from a group of families and children with a diagnosed polyposis syndrome 100% of parents agreed that the paediatric polyposis service met their needs and 90% of adolescents agreed.

Conclusion

The study highlights the importance of the nurse practitioner role and providing specialised services to children and families with polyposis syndromes, although previously children were having surveillance it has shown that parents and children feel supported and able to contact the nurse for advice, however it has been recognised that information giving to children about treatment and management is an area for improvement.

PP29 - EPIGENETIC AND GENETIC CHANGES IN NONMALIGNANT TISSUES OF OVARIES AND ENDOMETRIUM AS POSSIBLE PRECURSORS IN OVARIAN MULTISTEP TUMORIGENESIS.

A. Niskakoski¹, A. Pasanen², S. Kaur³, L. Renkonen-Sinisalo⁴, J. Mecklin⁵, R. Białtów⁶, P. Peltomäki⁷

¹Medical and Clinical Genetics Helsinki, ²Department of Obstetrics and Gynecology Helsinki, ³Department of Oral and Maxillofacial Diseases Helsinki, ⁴Second Department of Surgery Helsinki, ⁵Department of Surgery and Institute of Clinical Medicine Jyväskylä, ⁶Department of Obstetrics and Gynecology, Department of Pathology Helsinki, ⁷Department of Medical and Clinical Genetics Helsinki

Epithelial ovarian cancer has the highest fatality rate of all gynecological malignancies among women worldwide. Of all ovarian cancers, 5-10% are hereditary and Lynch syndrome (LS) accounts for 10-15% of these cases. Low-grade endometrioid and clear cell epithelial ovarian carcinomas (OCs), which are the most common type of LS-associated OC, are thought to develop from endometriosis. If that is the case, the earliest changes in LS-associated OC development could be detected already in the endometrium.

LS-associated ovarian and endometrial carcinogenesis resemble each other. Thus, our aim is to study nonmalignant tissues of the female reproductive system in relation to OC and endometrial cancer (EC) with the purpose to identify molecular changes that precede ovarian carcinoma development. We have collected a big number of clinical specimens derived from endometrial biopsies, prophylactic hysterectomies and salpingo-oophorectomies from LS mutation carriers (21 OC, 34 EC and 17 patients with endometrial hyperplasia) as well as sporadic cases for comparison (87, 38 and 76 cases, respectively). We have chosen epigenetic markers from our earlier studies to be tested by Methylation-specific multiplex ligation-dependent probe amplification and genetic markers from the literature, notably ARID1A among others (KRAS, BRAF, PIK3CA, P53 and L1CAM).

Inactivation of ARID1A was low in LS-associated hyperplasias (0% for simplex and complex hyperplasias and 13% for complex atypical hyperplasia), which is in agreement with observations from sporadic cases. On the other hand, in LS-associated OCs and ECs the inactivation percentage was high. We found 94% of inactivation in LS-OC and 65% in LS endometrial carcinoma which exceeds percentages reported for sporadic or hereditary cases in the literature. With a few exceptions, LS-associated OCs and ECs were mismatch repair (MMR) deficient. As a chromatin remodeler, ARID1A inactivation may contribute to deficient MMR, and conversely, MMR deficiency may induce mutations in ARID1A, which leads to inactivation of ARID1A expression.

While it is generally accepted that widespread MMR deficiency drives tumorigenesis in LS, the timing of molecular alterations is controversial. If it can be shown that alterations occur at stages that are still histologically regarded normal, it would be of major scientific and clinical importance.

PP30 - CHARACTERIZATION OF A NOVEL *POLD1* MISSENSE FOUNDER MUTATION IN A SPANISH POPULATION

R. Ferrer-Avargues¹, V. D ez-Obrero², E. Mart n-Tom s², E. Hern ndez-Ill n³, M. I. Castillejo¹, A. Codo er-Alejos⁴, V. M. Barber i¹, A. B. S nchez-Heras⁴,  . Segura⁵, M. J. Juan⁶, I. Tena⁷, A. Castillejo¹, J. L. Soto¹

¹Gen tica Molecular. Hospital Universitario Elche. Elche. Spain, ²An lisis Cl nicos. Hospital Universitario Elche. Elche. Spain,

³Unidad Investigaci n. Hospital Universitario Alicante. Alicante. Spain, ⁴Unidad Consejo Gen tico en C ncer. Hospital

Universitario Elche. Elche. Spain, ⁵Unidad Consejo Gen tico en C ncer. Hospital Universitario La Fe. Valencia. Spain, ⁶Unidad

Consejo Gen tico en C ncer. Instituto Valenciano Oncolog a. Valencia. Spain, ⁷Unidad Consejo Gen tico en C ncer. Hospital

Provincial Castell n. Castell n. Spain

Purpose

Previously, we identified a new and a recurrent *POLD1* mutation associated with predisposition to colorectal cancer (CRC). We aimed to characterize the molecular and clinical nature of the potential *POLD1* founder mutation in families from the Valencian Region in Spain.

Methods

Clinical and molecular data were collected from 4 independent families known to have a *POLD1*: c.1421T>C; p.(Leu474Pro) mutation. To establish its founder effect, haplotype construction was performed using 14 flanking *POLD1* polymorphic markers. We calculated penetrance estimates and clinical expressivity, globally and stratified by age and sex.

Results

We included 32 individuals from the 4 families: 20 carriers and 12 noncarriers. A common haplotype was identified in these families in a region comprising 2.995 Mb, confirming L474P as the first founder *POLD1* mutation identified. Twelve tumors diagnosed in 10 *POLD1* carriers: 8 CRC, 3 endometrial, and a gastrointestinal stromal tumor were considered. The median age of cancer onset for *POLD1* mutation carriers was 48 years. The observed penetrance was 50% and the cumulative risk at age of 50 was 30%.

Conclusions

Our findings contribute to a better understanding of CRC genetics in the Spanish population. The clinical phenotype for this mutation overlaps with that in Lynch syndrome and consequently, the recommended surveillance might be analogous.

PP31 - SEARCHING FOR A DRIVER MUTATION: LINKAGE ANALYSIS IN A SERRATED POLYPOSIS FAMILY

S. Rana¹, C. Palles², L. Chegwidden², I. Tomlinson², S. K. Clark¹, A. Latchford¹

¹St. Mark's Hospital London, ²Wellcome Centre for Human Genetics Oxford

Introduction

Patients with Serrated Polyposis Syndrome (SPS) as defined by the World Health Organisation (WHO) criteria, have an increased risk of colorectal cancer as do their first degree relatives (FDR). This suggests a genetic basis for the disease, though a susceptibility gene has yet to be identified. Recent studies have shown mutations in the *RNF43* gene in four families with SPS but this mutation is likely to only account for a small proportion of SPS. Searching for additional genetic risk factors is warranted.

Methods

A large family group with evidence of strong SPS inheritance was identified.

gDNA was extracted from individuals' blood samples using Promega Maxwell 16 Blood DNA Purification Kit. The Infinium HumanCoreExome BeadChip (Illumina) was used to genotype these individuals. Linkage analysis was carried out using Multi-point Engine for Rapid Likelihood Inference (MERLIN) software. 39528 SNPs were included after quality control steps and 12 SNPs excluded due to Mendelian errors. Non-parametric linkage analysis was performed under three conditions:

1. All family members classed as affected
2. WHO 2 members (III.5 & II.3) classed as unaffected
3. Only individual II.3 classed as unaffected (based on the assumption that III.5 has polyp burden that fell one short of satisfying WHO 1 and clinically is likely to have SPS based on his own phenotype rather than the FDR status alone).

Results

A single family with 7 individuals spanning two generations was studied. This included 5 siblings, of whom two are non-identical twins. Three, two and two family members satisfied WHO criteria III, I and II respectively. (Fig.1)

Genome wide linkage analysis data are summarized in table 1. Potential areas of interest on Chr 6 at cM Positions 4.4-16.4 and 184.4-192.4 were identified, when the analysis was performed with WHO 2 FDRs excluded and when analysed on the basis of individual phenotypic data and clinically likely SPS.

Discussion

Genome wide linkage analysis in a phenotypically well-defined family cohort with so many SPS affected members has yet to be described in the literature. We have identified two novel candidate regions in chromosomes 6, which require further analysis. Our results appear to be more significant when excluding WHO criteria 2 individuals, as affected cases. We aim to add sequencing data from a third family member from an earlier generation, with early age diagnosis of synchronous CRCs.



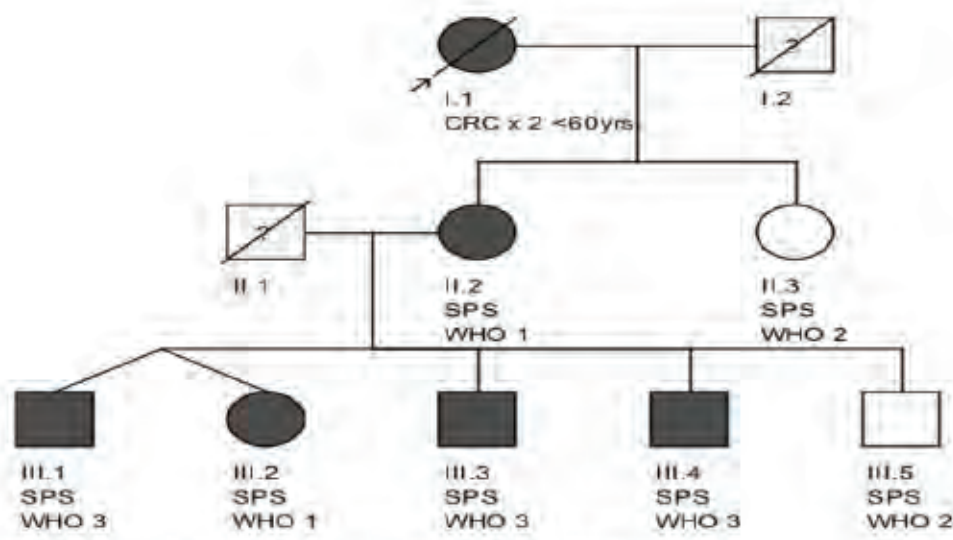

Fig 1. Pedigree of Serrated Polyposis Syndrome (SPS) Family.

SPS Affected Status	Chromosome	cM Position	LOD Score	P value
All Family Members affected	21	57.8 - 61.8	1.60	0.003
	14	10.0 - 30.0	1.60	0.003
	6	4.4 - 16.4	0.8	0.24
	6	184.4 - 188.4	0.07	0.30
WHO 2 members (II.3 & III.5) unaffected	21	45.8 - 65.8	0.8	0.02
	14	10.0 - 26.0	0.8	0.02
	6	4.4 - 16.4	1.80	0.002
Only individual II.3 unaffected	6	184.4 - 192.4	1.80	0.002
	21	49.8 - 65.8	1.21	0.01
	14	10.0 - 30.0	1.21	0.01
	6	4.4 - 16.4	2.40	0.0004
	6	184.4 - 192.4	2.36	0.0004

Table 1. Chromosomal areas of interest following linkage analysis of SPS family with variations in affection status

PP33 - BURDEN AND NEEDS OF PATIENTS WITH FAMILIAL ADENOMATOUS POLYPOSIS (FAP)

P. P. Becker¹, R. Hofmann¹

¹*Tillotts Pharma AG, Medical Affairs, Rheinfelden, Switzerland*

OBJECTIVES: For Familial Adenomatous Polyposis (FAP), a rare genetic disease characterized by the development of hundreds and thousands of adenomas throughout the gastrointestinal tract, a pharmacological treatment is still not available. Regular monitoring including minor polyp resections, but also major surgical interventions such as colectomy or pancreaticoduodenectomy are accompanying the patients life-long, in order to prevent the development of malignancies. Coping with the disease burden has an important impact on FAP patients' quality of life (QoL).

METHODS: An online questionnaire was distributed via three patient organizations in two different countries (Netherlands & United Kingdom). The inclusion criterion was FAP patient over 17 years. The completed questionnaires were categorized in three main groups (pre-colectomy (PRC), post-colectomy under duodenal surveillance (PCDS) and post-colectomy without duodenal surveillance (PC)). The answers were evaluated in order to identify key factors impacting patient's life in different stages of their disease.

RESULTS: A total of 207 completed polls could be evaluated (mean age: 44.1 years; female: 70%). As expected, the majority of patients had other family members suffering from FAP (80%). The cohort was analyzed in subgroups divided by cancer background, frequency of examinations and disease stage; however no subgroup was detected with a significantly higher impact on QoL. Different worries about cancer development and further surgery respectively examinations could be confirmed to have an important influence in patient's daily life. A retrospective evaluation of general wellbeing showed a marked decrease occurring with colectomy (Scale 0-10; mean: -3). A regain in wellbeing after colectomy was reported, showing clear time dependent behavior (0.7 to 1.8). Among the PC/ PCDS patients (89%) was an unexpected high number of patients with stoma bag (30%). However, this does not result in relevant differences in reported QoL compared to patients without a stoma bag.

CONCLUSIONS: Our study describes the QoL impact in the disease course of FAP patients. The subcategorization could not identify any parameters showing a significantly higher impact on QoL. This would allow to conclude that the main burden in FAP patients' life is not only caused by the actual physical progression of the disease but also by a constant level of uncertainty about this progression.

PP34 - THE QUESTION OF DESMOIDS AND POUCH SURGERY IN PATIENT WITH FAP: HOW MANY UPDATES DOES IT TAKE?

X. Xhaja¹, J. Church¹

¹Colorectal Surgery Cleveland

	2009		2012		2014	
	n	% with desmoids	n	% with desmoids	n	% with desmoids
Open IRA	43	9.3	39	10.3	39	10.3
Lap IRA	67	7.5	91	12.1	99	11.1
Open IPAA	69	15.9	50	22.0	55	20.0
Lap IPAA	19	42.1	30	30.0	29	31.0
Total	198		210		222	

Introduction

In 2009 we presented data suggesting that laparoscopic pouch surgery (IPAA) in patients with FAP was the most desmoidogenic of the four main surgical options. Since then we have reviewed our experience twice. Clinically, patients continue to develop desmoids after undergoing a laparoscopic IPAA. Here we summarize the three iterations of the data to stimulate discussion about this important point.

Methods

Patients with FAP who had open or laparoscopic colectomy with ileorectal anastomosis (IRA) or proctocolectomy with IPAA between 1993 and 2013 were entered into a database. The incidence of post-operative intra-abdominal desmoid tumors was determined. Patients with desmoid disease at index surgery were excluded. The data were reviewed on three occasions, each time adding and excluding cases as appropriate. The latest iteration of data has not been presented.

Results

The results are in the table

Discussion and Conclusion

The data have changed over the years as new records became available and charts were re-reviewed. However, the association of a strong desmoid tendency with laparoscopic IPAA has stayed significant over 7 extra years of follow-up with 24 extra patients.

PP39 - EVALUATION OF AN ONLINE FAMILY HISTORY TOOL FOR IDENTIFYING HEREDITARY AND FAMILIAL COLORECTAL CANCER

F. Kallenberg¹, F. The², C. Wientjes³, A. Depla⁴, M. Mundt⁵, P. Bossuyt⁶, C. Aalfs⁷, E. Dekker¹

¹Department of gastroenterology and hepatology, Academic Medical Center Amsterdam, ²Department of gastroenterology and hepatology, Onze Lieve Vrouwe Hospital East Amsterdam, ³Department of gastroenterology and hepatology, Onze Lieve Vrouwe Hospital West Amsterdam, ⁴Department of gastroenterology and hepatology, Medical Center Slotervaart Amsterdam, ⁵Department of gastroenterology and hepatology, Flevo Hospital Almere, ⁶Department of clinical epidemiology, biostatistics and bioinformatics, Academic Medical Center Amsterdam, ⁷Department of clinical genetics, Academic Medical Center Amsterdam

Background: When a hereditary colorectal cancer (CRC) syndrome or familial CRC is identified in a patient with CRC, this patient and the relatives at risk can be enrolled in surveillance protocols for prevention of metachronous cancer. At present however, these patients are not always diagnosed as such. We evaluated a validated online family history tool to facilitate the identification and referral of CRC patients at risk of having hereditary or familial CRC.

Methods: Between February 2015 and October 2016, we conducted a multicenter trial with a stepped-wedge design in CRC outpatient clinics at five Dutch hospitals and included all newly diagnosed CRC patients. All hospitals continued their standard procedures for identifying patients at risk and referring them to a clinical geneticist, and then switched to offering the online family history tool. Primary outcome measure was the proportion of CRC patients with a hereditary CRC syndrome or familial CRC who received surveillance recommendations.

Results: When using the online tool, 46 of 489 (9.4%) included CRC patients received a surveillance recommendation for themselves or their relatives, compared to 35 of 292 (12.0%) patients in the control strategy. In the model-based intention-to-treat analysis, in which we accounted for possible time trends and hospital effects, the difference was not significant ($p=0.58$).

Conclusion: An online family history tool does not necessarily assist in increasing the number of patients and relatives enrolled in surveillance recommendations for hereditary or familial CRC.

PP40 - NON-SYNDROMIC COLORECTAL CANCER (CRC) IN COLOMBIA -SOUTH AMERICA

M. Bohorquez¹, M. Echeverry de Polanco², L. G. Carvajal³

¹University of Tolima Ibaguá, Colombia south america, ²University of Tolima. Ibaguá, colombia south america, ³Genome Center & Department of Biochemistry and Molecular Medicine UC-davis USA

Objective: Approximately 5% of the cases of colorectal cancer with familial aggregation are associated with known syndromes such as Lynch syndrome, familial adenomatous polyposis, etc.; however, this percentage could rise to 30% or more if other issues could be taken into account, such as new alleles with phenotypic effects of different types of penetrance (medium, low, or with additive effect). In this study we identified families with clear aggregation that did not have mutations in known genes that have been studied for four decades.

Methods: A total of 1278 cases with CRC were studied, applying diagnostic criteria such as the Amsterdam, Bethesda and polyposis; of these, 126 patients were selected and next generation sequences (NGS) was used to study mutations in the genes APC, BMPR1A, CDH1, EPCAM, MLH1, MSH2, MSH6, PMS2, MUTYH, POLD1, POLE, PTEN, SMAD4, STK 11 and TP53.

Results: From the 126 patients, 69 families were identified and among them, 11 (16%) met the Amsterdam criteria, 43 (62%) the Bethesda guidelines and 15 (22%) the polyposis criteria. A total of 69 (15%) index cases were recorded, with 50 (11%) family members affected and 340 (74%) healthy. There were 11 cases of Lynch syndrome, of those, eight cases had a mutation in MSH2 (six of them not previously reported in Colombia) and three of those had mutations in MLH1 (two of those not previously reported in Colombia); in addition, there were 3 cases of polyposis (APC, SMAD4 and MUTYH). No mutations were observed in 55 families in the genes evaluated; five families complied with the Amsterdam criteria, 36 the Bethesda guidelines and 14 of polyposis. The patterns of inheritance found were autosomal dominant, with multiple CRC patients in the family and other related cancers and more than two consecutive generations affected.

Conclusions: Lynch syndrome is the most common CRC found in this cohort of families, the majority being MSH2 mutations. Most cases of CRC are not associated with known germline mutations, suggesting the presence of other mechanisms of pathogenesis. Other etiologic possibilities are proposed: familial CRC type X, MMR deficiency syndrome, or contributing factors of polygenic inheritance or epigenetic changes.

PP42 - A CASE OF COLORECTAL CANCER IN NIJMEGEN BREAKAGE SYNDROME

T. Clinick¹, J. Keating¹, I. Aljanabi¹

¹*General Surgery, Capital & Coast District Health Board Wellington*

Introduction

Nijmegen breakage syndrome (NBS) is a rare autosomal recessive genetic disorder characterised by microcephaly, radiosensitivity, immunodeficiency, and an increased risk of malignancy. The NBS-1 gene codes for nibrin; a protein involved in the repair of double-stranded DNA breaks and in cell cycle checkpoints. While lymphoma and a handful of other cancers have been described to occur in NBS, to our knowledge there are no other documented cases of colorectal cancer. There are, however, suggestions of an increased risk of colorectal, breast and prostate cancer in heterozygotes based on epidemiological data from family studies. This case report describes a case of colorectal cancer in a patient with NBS from Wellington, New Zealand.

Case report

A 33-year-old male with NBS presented with abdominal pain, diarrhoea and iron deficiency anaemia. A colonoscopy revealed a near-obstructing polypoid tumour in the descending colon. The patient proceeded to semi-elective surgery for a sigmoid colectomy without complications. Histology of the tumour showed a low-grade adenocarcinoma with 11 sampled lymph nodes being negative for malignancy. He recovered well from his surgery with a completion colonoscopy showing multiple tubular adenomata in the remaining colon only. Genetic testing showed that he was homozygous for the c.657_611delACAAA mutation in exon 6 of the NBN gene, the same mutation which has been reported in the majority of NBS patients. Our patient's father is of Polish extraction, with most patients in the NBS registry being of eastern European ancestry.

Discussion

Of all chromosomal instability syndromes, NBS has one of the highest incidences of cancer. By the age of 21, almost 40% have developed a malignancy, predominantly of lymphoid origin. Glioma, medulloblastoma and rhabdomyosarcoma have also been reported, but there are no reports of colorectal cancer. Epidemiological data suggests that NBS-1 heterozygotes have an increased risk of developing breast, prostate, and colorectal cancers. This correlation was strengthened by a study on 344 blood relatives of NBS patients. Thirteen developed malignancies of any type, including 11 carriers of the 657del5 NBS-1 mutation, compared with 6 expected. In this study, the most common types of cancer were stomach and colorectal.

Conclusion

This case report describes the previously undocumented occurrence of colorectal cancer in a patient with NBS, adding to the limited knowledge about this condition.

PP44 - THE INFLAMMATORY POTENTIAL OF THE DIET AND COLORECTAL TUMOR RISK IN PERSONS WITH LYNCH SYNDROME

J. Brouwer¹, M. Makama¹, G. van Woudenberg¹, H. Vasen², F. Nagengast³, J. Kleibeuker⁴, E. Kampman¹, F. van Duijnhoven¹

¹Department of Human Nutrition, Wageningen University & Research Wageningen, the Netherlands, ²Foundation for the Detection of Hereditary Tumors (StOET) Leiden, the Netherlands, ³Department of Gastroenterology, Radboud University Medical Center Nijmegen, the Netherlands, ⁴Department of Gastroenterology and Hepatology, University of Groningen, University Medical Center Groningen Groningen, the Netherlands

Background: Persons with Lynch syndrome (LS) have a high lifetime risk of developing colorectal tumors (CRTs) due to a germline mutation in one of their mismatch repair (MMR) genes. An important process in the development of CRTs is inflammation, which has been shown to be modulated by diet.

Objective: We aimed to investigate the association between the inflammatory potential of the diet and the risk of CRTs in persons with LS.

Design: We used dietary intake of 457 persons with LS from a prospective cohort study to calculate the adapted dietary inflammatory index (ADII). The ADII was split into tertiles in which the highest tertile reflects the most pro-inflammatory potential of the diet. Cox proportional hazard models, with robust sandwich variance estimates to adjust for dependency within families, were used to calculate hazard ratios (HR) and confidence intervals (CI) of CRTs by ADII tertile. HRs were adjusted for age, smoking status, education level and number of colonoscopies as time-dependent variable. Stratified analyses were performed by mutated MMR gene. We performed sensitivity analyses by repeating the analyses among non-NSAID users (N=315).

Results: During a median follow-up time of 59 months, 200 (43.8%) participants developed CRTs. The ADII was positively, though statistically not significantly, associated with CRT risk (HR_{highest vs. lowest tertile}: 1.37 [95% CI: 0.80-2.34]). Stratification by mutated MMR gene resulted in an HR_{highest vs. lowest tertile} of 1.67 (95% CI: 0.90-3.12) for participants with an *MLH1* mutation and of 1.29 (95% CI: 0.52-3.18) for those with an *MSH2* mutation. The association was accentuated among non-NSAID users (HR_{highest vs. lowest tertile}: 1.60 [95% CI: 0.88-2.93]), especially among *MLH1* mutation carriers (HR_{highest vs. lowest tertile}: 2.36 [95% CI: 1.05-5.30]).

Conclusion: The results suggest that a pro-inflammatory potential of the diet may increase CRT risk in persons with LS.

PP45 - EXOME SEQUENCING APPROACH FOR IDENTIFICATION OF HIGH-RISK GENETIC VARIANTS IN FCC-X FAMILIES

L. Martin-Morales¹, A. Tosar¹, J. Delgado¹, P. Rofes¹, V. Lorca¹, M. de la Hoya¹, P. Garre¹, T. Caldes¹

¹*Molecular Oncology. IdISSC Madrid*

Hereditary non-polyposis colorectal cancer (HNPCC-CRC) without mismatch repair (MMR) defects occurs in almost half of high risk CRC families, but its genetics cause(S) is still unknown. These group of families are known as FCC-X.

Identifying the genetic basis underlying Familiar Colorectal Cancer Type X (FCC-X) has been a challenge that many research groups have faced over the last years. Thanks to the arrival of Next Generation Sequencing (NGS), this goal has become more achievable. However, this type of studies have only succeeded in identifying a clear pathogenic mutation in a small fraction of these families, leaving the remaining ' for now ' with merely a list of candidate genes. Nevertheless, we believe it is still important to share this kind of information with the rest of the community, so as to keep expanding our knowledge of this heterogeneous group of families.

In order to find new high-penetrance cancer-predisposing genes in this subgroup of hereditary CRC, whole-exome sequencing was performed in a total of 32 members from 13 FCC-X families. After thorough filtering, a number of candidate variants affecting interesting genes as PTPRT, SHF, MAPK15, LAMA5, BRCA2, POLQ, PYGO1, SETD6, PLEC, NQO2, were selected for each family . Even though different tests to evaluate the effects of some of these mutations are still ongoing, we will present the most relevant results obtained so far in this tough searching to further understand the cancer heritability of FCC-X.

PP46 - LYNCH SYNDROME-RELATED TUMORS IN THE PATIENTS WITH JAPANESE LYNCH SYNDROME

C. Saita¹, T. Yamaguchi¹, M. Takao¹, H. Kawamura¹, Y. Nakayama¹, D. Nakano¹, H. Matsumoto¹, K. Takahashi¹

¹Tokyo Metropolitan Cancer and Infectious diseases Center Komagome Hospital Tokyo

Introduction: Lynch syndrome (LS) with autosomal dominant disorder is caused by germ-line mutation in mismatch repair (MMR) genes. LS patients are at high risk for developing LS-associated tumors, such as colorectal and endometrial cancers. Most of recent data concerning LS-associated tumors have been reported from Western countries, but there is no report after 2000 from Japan. Therefore, to clarify the characteristics of LS-associated tumors, we analyzed the clinical and genetic data from Japanese LS patients.

Methods: This is a retrospective review of LS patients from the Tokyo Metropolitan Cancer and Infectious diseases Center Komagome Hospital. We investigated all malignant tumors that LS patients have developed, including LS-related tumors according to the Revised Bethesda Guidelines. Statistical analysis was performed using Fisher's exact test and the Mann-Whitney U-test. Cumulative cancer risks were calculated using the Kaplan-Meier method, and the log-rank test was used to compare risks between two groups.

Results: We analyzed 55 LS patients in 34 LS families with mismatch repair gene mutation (31 patients with MLH1, 17 with MSH2, 7 with MSH6). The median age at diagnosis of the first malignant tumor and the first LS-related tumor were 44 (range 19-65) and 44 (range 24-66), respectively. Forty-five patients were developed LS-related tumor as the first malignant tumor. Colorectal cancer (CRC) was developed in 47 patients (85.4%), diagnosed at the median age of 46 and 52 years for male and female, respectively. Endometrial cancer was the second common cancer (42.8%), diagnosed at median age of 50 years, followed by gastric cancer (18.1%). A total of 29 patients (52.7%) developed both CRC and extra-colonic tumor, of which 15 (48.3%) occurred in MLH1, 10 (58.8%) in MSH2, 4 (57.1%) in MSH6. The cumulative incidences of CRC at the age of 50 were 57.7% (95% confidence interval [CI], 41.4-69.5%), 30.2% in endometrial cancer (95%CI, 0.0-49.4%), and 10.8% (95%CI, 0.0-20.5%) in gastric cancer, respectively.

Conclusions: Compared with previous reports from Western countries, cancer risk of gastric cancer was higher in our hospital. More than half of the LS patients developed CRC and other site of malignant tumors, suggesting a need to develop methods to screen and follow up of extra-colonic cancer.

PP48 - DEEP SEQUENCING OF LYNCH SYNDROME TUMORS HIGHLIGHTS EPIGENETIC EVENTS

N. Porkka¹, S. Valo¹, T. T. Nieminen¹, A. Olkinuora¹, S. Eldfors², P. Peltomäki¹

¹Department of Medical and Clinical Genetics Helsinki, ²Institute for Molecular Medicine Finland Helsinki

Lynch syndrome (LS) is caused by defects in mismatch repair (MMR) genes, notably *MLH1*, *MSH2*, *MSH6*, and *PMS2* genes. Defects in MMR gene function cause accumulation of replication errors leading to increased somatic mutation rate in the genome. Our aim was to investigate the somatic mutation profiles in MMR defective colorectal carcinomas (CRC), colorectal adenomas (CRA), and ovarian carcinomas (OC) from LS mutation carriers.

LS tumor and matching normal DNA were sequenced using Nimblegen Comprehensive cancer panel, which covers 578 known cancer related genes. Somatic mutation analysis was conducted according to paired sample sequencing data and the detected mutations were categorized based on the mutation frequency (low mutation frequency <0.25 vs. high mutation frequency ≥ 0.25). Tumor samples were stratified by CpG island methylator phenotype (CIMP).

The mean frequency of somatic mutations in colonic tumors (1245) was significantly higher compared to ovarian tumors (657) ($p=0.004$). In the combined tumor series (CRC + CRA + OC), the mean frequency of somatic mutations, number of mutated genes, and number of mutated genes with at least one high-frequency mutation were significantly higher in CIMP positive compared to CIMP negative tumors ($p=0.011$, $p=0.019$ and $p=0.004$, respectively).

Genes harboring high-frequency mutations in at least 31% of tumors were regarded candidates for driver genes. There were 72 such genes in colonic tumors (CRC + CRA), compared to 10 in OC. Epigenetic genes were significantly enriched in both sets of genes. Some genes showed tissue-specific involvement: four Wnt signaling genes were preferentially mutated in colorectal tumors whereas two PI3K signaling genes were associated with ovarian carcinomas. The top mutated genes shared by ovarian and colorectal carcinomas were *ARID1A*, *BCR*, *CHD5*, *RPL22* and *TSC2*.

Collectively, the findings suggest that LS tumorigenesis is strongly influenced by epigenetic events, as a consequence of regulatory changes (CIMP) or somatic mutations in key epigenetic genes. Our results are clinically important since many of the affected pathways are actionable by targeted therapies.

PP50 - COLORECTAL POLYPS AND CANCERS IN THE FOLLOW-UP OF ASYMPTOMATIC INDIVIDUALS WITH CONSTITUTIONAL MISMATCH REPAIR GENE MUTATIONS

L. Roncucci¹, M. Pedroni¹, F. Mariani¹, G. Rossi¹, F. Domati¹, L. Reggiani-Bonetti¹, P. Benatti¹, M. Ponz de Leon¹

¹*Department of Diagnostic and Clinical Medicine, and Public Health, University of Modena and Reggio Emilia, Modena, Italy*

Aim of the study is to report the clinical follow-up of individuals carrying a MLH1, MSH2, or MSH6 mutation (Lynch Syndrome gene carriers, MUT+) with particular attention to the development of colorectal polyps and cancers of large bowel and other organs.

Methods. 81 gene carriers (MLH1: 40, MSH2: 35, MSH6: 6) diagnosed in 46 families with Lynch Syndrome between 1993 and 2015 were evaluated and compared with 111 individuals belonging to the same families, negative for Mismatch Repair mutations (MUT-). The mean follow-up time was 8.4 ± 6.6 years (range 1-23) in MUT+ and 10.2 ± 7.4 years (range 1-22) in MUT-. Compliance to follow-up was 83% in MUT+, and 61% in MUT-; the mean number of endoscopies 3.0 ± 2.8 in MUT+ vs 1.6 ± 1.9 in MUT-.

Results. In 17 Mut+ (21%) one or more polyps were observed in the follow-up, vs 13 (11.7%) in MUT-. The total number of polyps was 68 in MUT+ and 32 in MUT- ($p < 0.01$). The majority of polyps was adenomas (71%) in MUT+, hyperplastic/serrated (59%) in MUT-. Polyps were more frequent in MLH1 mutation carriers (44 vs 13). Among the 81 MUT+, twenty malignant tumours in 13 individuals were observed, vs 5 malignant tumours in 4 MUT- individuals ($p < 0.01$). The average age of onset of tumours was 41.9 ± 7.7 in MUT+, and 46.0 ± 18.0 years in MUT-. In MUT+ the tumour spectrum was characterised mainly by colorectal cancer (no.4) cancer of the uterus (no.3, 2 of which cervical cancers) urothelial cancer (no.3), cancer of the central nervous system (no.3) and cancer of the skin (no.2).

Conclusions. Compliance to follow-up colonoscopies was very good among MUT+ (>80%), even though only few individuals completed all the suggested examinations. As expected, MUT+ developed more polyps than MUT-, mainly adenomas. Among MUT-, hyperplastic/serrated polyps were more frequent in the follow-up. MLH1 gene carriers seem to develop more polyps than MSH2 gene carriers. MUT+ developed malignant tumours than MUT-. However, most malignant tumours (16 of 20, 85%), were observed outside the large bowel, or in organs for which an effective surveillance is unavailable. The small number of colorectal cancers observed in the follow-up of MUT+ might be due to endoscopic surveillance.

PP51- HIGH PREVALENCE OF MSH6 AND PMS2 PATHOGENIC VARIANTS IN UNSUSPECTED LYNCH SYNDROME

J. Stoll¹, E. Rosenthal², S. Cummings², J. Willmott², R. Bernhisel², S. Kupfer¹

¹University of Chicago Medicine Chicago, IL, ²Myriad Genetic Laboratories Salt Lake City, UT

Background: Lynch syndrome (LS) testing criteria were developed based on families with striking cancer histories across multiple generations. Pathogenic variants (PVs) in mismatch repair (MMR) genes *MLH1* and *MSH2/EPCAM* underlie most of these highly penetrant families. These testing criteria are likely to miss individuals with LS due to PVs in the less penetrant MMR genes *MSH6* and *PMS2*. The introduction of multigene panels including the MMR genes as a modality for testing individuals who may not meet LS testing criteria provides an opportunity to determine distribution and prevalence of MMR gene PVs based on whether the personal/family history met LS testing criteria.

Methods: The prevalence of PVs in each of the MMR genes was established in the entire cohort of 310,224 individuals tested in a commercial laboratory with a 25-gene pan-cancer panel. Results were compared to those in: 1) the 30,771 cases where providers indicated ascertainment for suspicion of LS, and 2) the 68,668 cases submitted with a clinical history meeting current Lynch syndrome testing from the National Comprehensive Cancer Network (NCCN).

Results: Of 310,224 individuals tested, 2,783 carried a PV in an MMR gene (0.90%), distributed as: *MLH1* (16.7%), *MSH2/EPCAM* (23.2%), *MSH6* (28.9%), *PMS2* (31.4%). Close to 70% of *MLH1* and *MSH2/EPCAM* PV carriers were tested for suspicion of LS, and close to 90% met NCCN LS testing guidelines (**Figure 1**). In contrast, the majority of *PMS2* PVs were identified in tests not ordered for suspicion of LS and in individuals who did not meet NCCN guidelines. A slight majority of *MSH6* PV carriers met NCCN guidelines, but less than half had LS as the indication for testing. These differences in mutation spectrum are statistically significant ($p < 0.001$). **Figure 2** contrasts the distribution of PVs identified in MMR genes based on LS testing criteria.

Conclusions: PVs in *MSH6* and *PMS2* are a more common cause of LS than previously suspected, likely due to lower penetrance associated with these genes. Current testing criteria identify the majority of individuals with PVs in highly penetrant genes *MLH1* and *MSH2/EPCAM*. However, they are likely to miss the majority of individuals with PVs in *MSH6* and *PMS2*. Additional research is needed to determine whether testing for LS in patients whose personal and/or family history do not meet LS testing criteria is warranted given that these PVs are clinically actionable with established management guidelines.

Figure 1. Proportion of individuals with a PV in an MMR gene who were ascertained for testing based on a clinical suspicion of Lynch syndrome (LS) or who met LS testing criteria.*

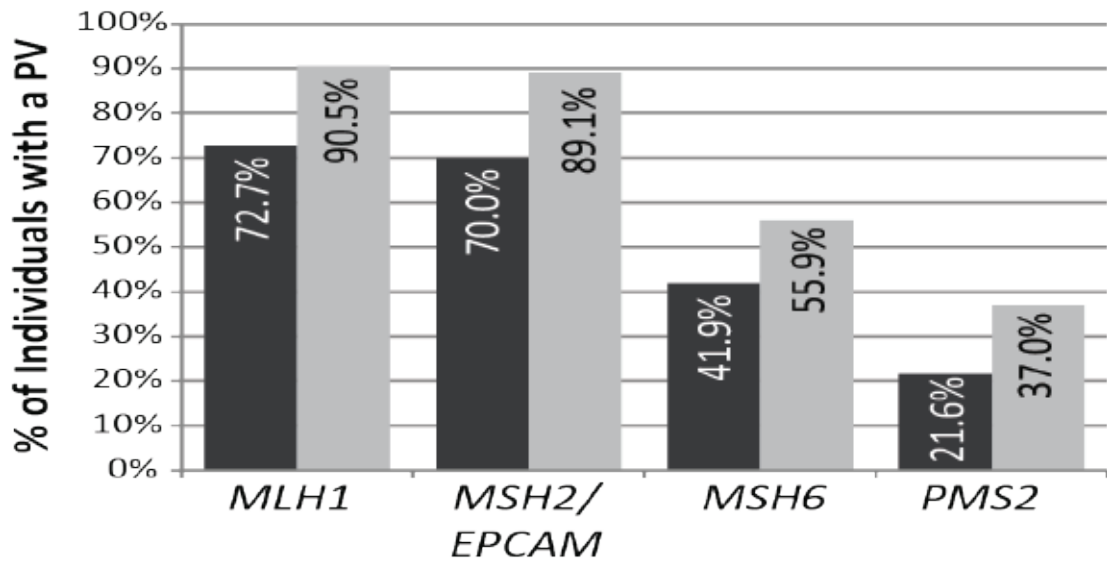

■ Panel ordered for indication of LS (as indicated by check box on the test requisition)

■ NCCN criteria met (based on personal and family history listed on the test requisition)

*5 individuals with PVs in 2 different MMR genes are excluded.

Figure 2. Spectrum of pathogenic variants in MMR genes based on whether NCCN guidelines were met (left panel) or were not met (right panel).*

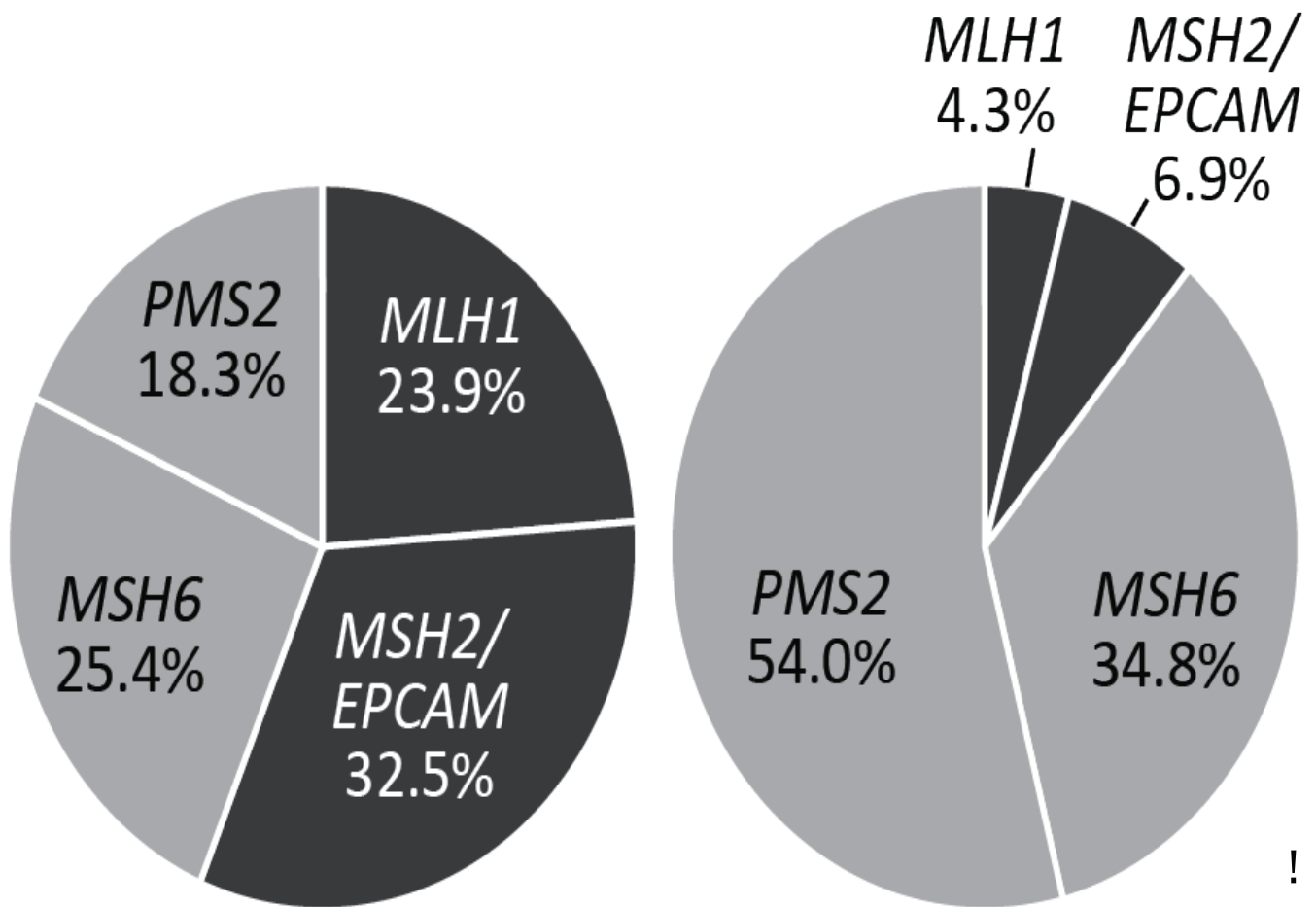

*5 individuals with PVs in 2 different MMR genes are excluded.

PP52 - IDENTIFICATION OF MISMATCH REPAIR DEFICIENT TUMOURS USING A MOLECULAR INVERSION PROBE BASED SEQUENCING ASSAY OF SHORT HOMOPOLYMER REPEATS

R. Gallon¹, H. Sheth¹, L. Redford¹, G. Alhilal¹, A. Miguel Alonso², S. Moreno Laguna², M. Arends³, O. O'Brien⁴, S. Needham⁴, A. Oniscu³, M. Jackson¹, M. Santibanez-Koref¹, J. Burn¹

¹Institute of Genetic Medicine, Newcastle University Newcastle-upon-Tyne, ²Servicio de Genética Médica, Complejo Hospitalario de Navarra Pamplona, ³Western General Hospital Edinburgh, ⁴Northern Genetics Service, Newcastle Hospitals NHS Foundation Trust Newcastle-upon-Tyne

Recent draft guidelines from the UK's National Institute of Health and Care Excellence recommends microsatellite instability (MSI) testing to be performed in all patients with colorectal cancer to identify Lynch syndrome patients. It is estimated that 3 or 4 per 1000 people in the population carry a mismatch repair (MMR) gene defect but only 10% of these are known to medical services. This is in part due to the lack of an automatable, robust, reliable and high throughput MSI assay.

We have previously shown a next generation sequencing based MSI assay using 17 short homopolymer repeats (7-12 bp). Short repeats are less prone to technical artefact than the longer repeats used in existing assays, and are sufficient in number to provide sensitivity and specificity equivalent to fragment analysis. We have enhanced the assay performance by selecting from the TCGA database those intragenic repeats that are linked to an informative SNP. This allows simultaneous separation of PCR artefacts linked to either allele from genuine mutations which display allelic imbalance. Using fragment analysis as the reference technique, we have demonstrated >97% sensitivity and specificity in residual samples from diagnostic labs in Newcastle, Edinburgh and Pamplona. However, the current laboratory procedure requires individual amplification of each repeat for every sample with subsequent pooling and library preparation, which adds cost and complexity.

We have upgraded the assay to carry out a simple two-step multiplexed target capture and library preparation method which utilises molecular inversion probes (MIPs). We demonstrate that MIPs allow multiplexing of the 17 marker panel plus inclusion of *BRAF* V600E analysis for minimal additional cost. The MIP mode of action minimises PCR and sequencing induced error rates. We will present results of the assay sensitivity, robustness and reproducibility against fragment analysis technique using DNA from fresh and FFPE tissues.

Our novel assay has the potential to streamline diagnostic pathology services by providing a quick and automatable assay for MSI detection. This could speed up the diagnosis pathway and improve the current poor rate of diagnosis of MMR-deficient tumours. This could be a major step towards timely personalised care for patients with MMR-deficient cancers, including access to immunotherapy, and may help find families at high genetic risk.

PP55 - UNIVERSAL SCREENING FOR LYNCH SYNDROME IN GASTRIC CANCER PATIENTS

K. Yamashita¹, K. Onodera¹, T. Kubo¹, E. Yamamoto¹, H. Suzuki², H. Yamano¹, H. Nakase¹

¹Department of Gastroenterology and Hepatology, Sapporo Medical University Sapporo, ²Department of Molecular Biology, Sapporo Medical University Sapporo

Background: Gastric cancer is regarded as one of Lynch syndrome-associated malignancies. However, it is unknown whether universal screening in gastric cancer patients is useful to identify Lynch syndrome in a high-prevalence country.

Methods: Consecutive gastric cancer patients at our department were screened for microsatellite instability (MSI). MSI was analyzed using 2 mononucleotide markers (*BAT26* and *BAT25*), and additional 3 markers were used to confirm the diagnosis. Mutation in 2 or more microsatellite markers was defined as MSI-H. Hypermethylation of *MLH1* promoter was analyzed for MSI-H gastric cancers by pyrosequencing. Germline mutation of mismatch repair (MMR) genes was analyzed for *MLH1* unmethylated cases by direct sequencing and multiplex ligation probe amplification (MLPA).

Results: Of 200 gastric cancers examined, 19 (9.5%) cancers were MSI-H. All MSI-H gastric cancers were Lauren's intestinal or mixed type, and 16 of 19 were stage IA. Patients with MSI-H gastric cancer (n=15) were older than MSS cancer patients (n=167), but the difference was not significant (73.3 vs 69.7 years old, respectively, p=0.13). Of 15 MSI-H gastric cancer patients, one had past history of double colon cancers and 5 had multiple gastric cancers. One MSI-H gastric cancer patient had cancer family history fulfilling the revised Amsterdam criteria, and other 2 patients had one first degree relative with colon cancer. *MLH1* promoter was methylated and unmethylated in 14 (74%) and 5 (26%) of 19 MSI-H gastric cancers, respectively. Of 5 *MLH1* unmethylated MSI-H gastric cancer patients, one met the revised Amsterdam criteria, whereas other 4 patients did not meet even the revised Bethesda guidelines. Two *MLH1* unmethylated MSI-H gastric cancer patients were subjected to MMR germline mutation analysis, but no pathogenic mutation was found in *MSH2*, *MLH1*, *MSH6* and *PMS2*.

Conclusions: We could not identify Lynch syndrome by universal MSI screening in gastric cancer patients. Cause of MMR deficiency in MSI-H gastric cancer without *MLH1* methylation remains unclear.

PP57 - A LARGE PROPORTION OF PATIENTS WITH LYNCH SYNDROME STILL UNDERGO GENETIC SCREENING IN CONNECTION TO THEIR DIAGNOSIS OF CANCER

S. Walton Bernstedt¹, A. Backman¹, J. Björk¹

¹ Center of Digestive diseases, Karolinska University hospital, Solna, Sweden Stockholm

Introduction

Lynch syndrome is caused by germline mutations in the mismatch repair (MMR) genes *MLH1*, *MSH2*, *MSH6*, *PMS2* and *EPCAM*. It is estimated to cause almost 3% of all colorectal cancer (CRC) in Sweden but since only a minority of CRC cases is evaluated for mutations it might be a higher proportion. Apart from CRC, Lynch syndrome is associated with a wide spectrum of extracolonic cancers, such as endometrial cancer. It is important to identify these patients at an early age to be able to prevent cancer in this group.

Aims & Methods

The aims of the study were to identify reasons leading to diagnosis of Lynch syndrome in the cohort registered at the Centre for Digestive Diseases at Karolinska University Hospital. The study was performed as a register study. Data was reviewed from medical files. Criterion for inclusion was an index visit to the outpatient clinic.

Results

121 patients were registered. 58% (n=70) were females and 42% (n=51) were males. The distribution of *MLH1*-, *MSH2*-, *MSH6*-, and *PMS2* carriers were 56% (n=67), 22% (n=27), 10% (n=12) and 8% (n=10), respectively. Four percent (n=5) of the patients had mutations affecting more than one mismatch repair gene. 56% (n=68) patients were found to have been investigated for Lynch syndrome due to carrier testing, 15% (n=18) due to family history of cancer and 29% (n=35) due to cancer in the patient's own medical history. Those diagnosed due to cancer (median 49 years, range 31-80) were older than those diagnosed due to carrier testing and family history (median 35 years, range 16-67, $P<0.01$). In total, 87 cancers were detected, most of which were CRCs (n=49), followed by endometrial cancer (n=8) and skin cancer (n=6). Median age at diagnosis for CRC was 50 years and 67% (n=33) of CRCs were located in the proximal colon.

Conclusion

Almost one third of the patients were identified as having Lynch syndrome first after they had been diagnosed with an associated cancer. This group was older than those diagnosed due to carrier testing and family history. This finding indicates that it is important to improve identification of MMR gene mutation carriers in the population before they develop cancer, thereby making preventive actions possible.

Cause for diagnosis of Lynch syndrome in relation to age, n=121

Patients diagnosed by malignancies have been diagnosed due to colorectal cancer, endometrial cancer or skin tumour. Carrier testing was defined as when a person at risk is referred within the healthcare system in order to be tested for an MMR mutation that has been identified in the family. Family history was defined as when a patient is referred within the healthcare system in order to investigate whether or not he/she has Lynch syndrome or another hereditary cancer syndrome based on a family history of malignancies.



PP60 - DNA METHYLATION CHANGES IN LYNCH SYNDROME-ASSOCIATED NORMAL COLONIC MUCOSA, ADENOMAS AND CARCINOMAS

S. Valo¹, S. Määki-Nevala¹, A. Ristimäki², L. Renkonen-Sinisalo³, A. Lepistö⁴, J. Mecklin⁵, M. Nyström⁶, P. Peltomäki¹

¹Department of Medical and Clinical Genetics, University of Helsinki Helsinki, Finland, ²Department of Pathology, Research Programs Unit and HUSLAB, Helsinki University Hospital and University of Helsinki Helsinki, Finland, ³Colorectal Surgery, Abdominal Centre, Helsinki University Hospital and Research Programs Unit, Genome-Scale Biology, University of Helsinki, Helsinki, Finland Helsinki, Finland, ⁴Colorectal Surgery, Abdominal Centre, Helsinki University Hospital Helsinki, Finland, ⁵Department of Surgery, Jyväskylä Central Hospital and University of Eastern Finland Jyväskylä, Finland, ⁶Department of Biosciences, University of Helsinki Helsinki, Finland

Colorectal cancer (CRC) develops via multiple steps which involve genetic changes, such as mutations in growth-regulatory genes, and epigenetic alterations, such as CpG island hypermethylation. Lynch syndrome (LS) is associated with inherited defects of the DNA mismatch repair (MMR) genes, which together with other genetic and epigenetic changes are known to accelerate tumorigenesis. However, early events leading to polyp formation and the timing and order of the molecular “hits” remain unknown. Studies on sporadic CRC have demonstrated that promoter hypermethylation leading to gene silencing can act as an alternative mechanism to mutations at early stages of tumor development but its importance in hereditary CRC remains unknown. In this study we aimed to define methylation changes that occur at different stages of LS-associated tumor progression.

Colorectal biopsies were prospectively collected from 104 LS mutation carriers during colonoscopy surveillance, supplemented with retrospective tumor specimens from 56 patients. Tumor specimens included adenomas with low- or high-grade dysplasia and carcinomas. Promoter methylation was analyzed using the methylation-specific multiplex ligation-dependent probe amplification test (MS-MLPA) including selected tumor suppressor and inflammatory genes associated with early colon oncogenesis. Hypermethylation tendency was evaluated based on the frequency of CpG island methylator phenotype (CIMP) according to the methylation status of eight established CIMP marker genes. LINE-1 methylation was studied as a surrogate marker for global hypomethylation. Immunohistochemistry was used to detect MMR protein expression in neoplastic lesions.

Results indicate that the expression of the MMR protein corresponding to the gene mutated in the germline decreases along with dysplasia but occurs as a relatively late event in the tumor progression, suggesting the presence of other somatic events that drive neoplastic transformation. Moreover, methylation increased in LS adenomas and carcinomas along with dysplasia. A proportion of low-grade adenomas could already be classified CIMP positive, and the frequency of CIMP further increased in high-grade adenomas and carcinomas. These findings emphasize the importance and early appearance of epigenetic alterations in LS-associated tumorigenesis.

PP61 - EUROPEAN REFERENCE NETWORK ON RARE GENETIC TUMOUR RISK SYNDROMES (ERN GENTURIS).

N. Hoogerbrugge¹

¹*Human Genetics Nijmegen*

ERN GENTURIS is a European Reference Network (ERN) for all patients with one of the rare genetic tumour risk syndromes (genturis). These patients are at very high hereditary risk of developing multiple tumours, which are often located in multiple organ systems. In case they are diagnosed with cancer they need different treatment and follow-up as compared to nonhereditary cancers. In addition GENTURIS takes care of the relatives of these patients, for which prevention and early detection of tumours is of great importance too.

WHAT IS OUR MISSION: To inspire hope and contribute to health and well being by organizing and providing the best care to every patient in Europe with a genetic tumour risk syndrome through integrated multidisciplinary healthcare, guidelines, education and research.

WHAT IS OUR DESIRED END-STATE: Striving to be the world's leader of genetic tumour risk syndromes in patient participation, clinical care, research and education.

The ERN GENTURIS is addressing the following challenges when it comes to the identification, genetic testing, tumour prevention and treatment of patients with genturis:

- 1) Great majority of genturis patients are not yet identified
- 2) Large variation in clinical outcomes resulting in impaired prognosis and avoidable costs
- 3) Guidelines are lacking or implemented insufficiently
- 4) Almost no patient registries and biobanks
- 5) Limited research programs
- 6) Fragmented patient empowerment activities.

There are 4 THEMATIC groups of syndromes:

1: Lynch syndrome & polyposis.

2: Neurofibromatosis type 1, 2 & Schwannomatosis.

3: Hereditary breast & ovarian cancer.

4: Other rare - predominantly malignant - syndromes. This group includes syndromes not covered in the other groups. It is a heterogeneous group with very small numbers of patients that will benefit greatly from a centralized approach.

GENTURIS is based on mature existing networks showing a high level of collaboration and functionality. For example is the Lynch syndrome & polyposis expert HCPs and researchers from major centres has strong links with INSIGHT.

PP62 - IMMUNOHISTOCHEMISTRY AND MSI OF TUMORS IN NORWEGIAN PMS2 MUTATION CARRIERS

E. M. Grindedal¹, E. S. RÅyset², A. T. Stormorken¹, A. Sylvander³, S. T. NergÅrd¹, W. Sjursen⁴

¹Department of Medical Genetics, Oslo University Hospital Oslo, ²Department of Pathology, St. Olavs Hospital Trondheim,

³Department of Medical Genetics, St. Olavs Hospital Trondheim, ⁴Department of Laboratory Medicine, Children and Women's Health, Norwegian University of Science and Technology Trondheim

Background: Immunohistochemistry (IHC) and microsatellite instability analysis (MSI) are often used to select patients for genetic testing of the MMR-genes. We have previously demonstrated that IHC alone would detect only 12.5% of carriers of the Norwegian PMS2 founder mutation c.989-1G>T. The aim of the current study was to investigate the sensitivity of IHC and MSI to detect carriers of other PMS2 mutations.

Material and methods: IHC and MSI was performed on all available tumors in affected carriers or obligate carriers of pathogenic PMS2 mutations registered in the patient journals at Section of Inherited Cancer, Oslo University Hospital, and Department of Medical Genetics, St. Olavs Hospital, Trondheim. The study was carried out as a quality of care analysis.

Results: Preliminary findings included IHC results of 31 tumors and MSI results of 29 tumors from 31 PMS2 mutation carriers. Excluding results from IHC and MSI analysis of a breast cancer, a sarcoma of the uterus and a pulmonary carcinoid tumor, 15/29 (51.7%) showed normal staining of PMS2 on IHC and 7/26 (26.9%) were MSS.

Conclusions: IHC or MSI alone would have failed to detect 52% and 27% of PMS2 mutation carriers respectively. If tumor testing is used to select patients for MMR-testing, both IHC and MSI should be performed. If economic resources allow for it, sequencing and MLPA should be performed instead of tumor testing. Updated results of more tumors will be presented.

PP63 - SURGICAL STRATEGY IN PATIENTS WITH FAMILIAL ADENOMATOUS POLYPOSIS

L. Duraes¹, M. Kalady¹, J. Ashburn¹, J. Church¹

¹Cleveland Clinic Foundation Cleveland

Type of operation, stratified by year										
	2008	2009	2010	2011	2012	2013	2014	2015	2016	Total
IRA	15	14	8	12	12	4	4	5	8	82
IPAA	8	8	6	7	5	6	7	2	2	51
Other	1	1	2	0	1	0	0	0	0	5
Total	24	23	16	19	18	10	11	7	10	138

Purpose

Patients with Familial Adenomatous Polyposis (FAP) usually have elective prophylactic colectomy to prevent the development of cancer. Such patients are often asymptomatic and young. The main surgical options are total colectomy with ileorectal anastomosis (IRA) and total proctocolectomy with ileal pouch-anal anastomosis (IPAA), both of which can be performed laparoscopically. IRA is usually selected for patients with <20 rectal polyps and <1000 colonic polyps while more severely affected patients have an IPAA. However the impact of IPAA on lifestyle is significantly worse than IRA, and this is a significant issue in young asymptomatic patients. In addition IPAA seems more likely to stimulate desmoid disease. We examined the pattern of surgeries performed here over the last 8 years to see if there is a move to increasing conservatism.

Methods

A prospectively collected inherited colorectal cancer database was queried to identify FAP patients undergoing large bowel surgery from 2008 to now. Only patients who had their index operations in our institution were included. Surgical treatment choice was compared between years, and with the prior cohort of patients operated between 1992 and 2007. Outcomes and quality of life were compared between surgery types.

Results

Between 1992 and 2007 254 patients underwent index surgery for FAP and between 2008 and 2016 it was 138. The median age was 26 and 27 years respectively. Between 1992 and 2007 141 patients had an IRA (57%) with 108 (43%) patients having an IPAA. Between 2008 and 2016 the numbers were 82 (62%) IRA, 51 (38%) IPAA ($p=0.342$). The number of polyps in the rectum was the main indication for IPAA. In the latter time period 42% of the patients submitted to IPAA had more than 20 polyps in the rectum vs while only 5% on patients submitted to IRA ($p<0.001$).

Laparoscopy has been used in 80% of the more recent cases compared to 43% from 1992 to 2007 ($p<0.001$). More IRAs were done laparoscopically than IPAA (1992-1999, 56% and 13%; 2000-2007, 58% and 23%; 2008-2016, 87% and 75%, respectively). The current conversion rate is 2.8% for TAC, and 7.9% for IPAA ($p=0.227$).

Of the IPAA 32% were one stage from 1992-2007 (without diversion), versus 16% from 2008-2016 ($p=0.026$). 21% had a mucosectomy and handsewn anastomosis from 1992 to 2007, versus 14% from 2008 to 2016 ($p=0.206$). 85% had J pouch configurations from 1992 to 2007, versus 92% from 2008-2016 ($p=0.216$).

Conclusion

We prefer minimally invasive colectomy and IRA as index prophylactic colorectal surgery in patients with FAP. This represents a conservative surgical approach. Longer follow up is needed to examine the implications of this change for the retained rectums.

PP64 - INCIDENCE OF COLORECTAL AND ENDOMETRIAL CANCER IN INDIVIDUALS FROM FAMILIES SUSPECTED OF HAVING LYNCH SYNDROME: A PROSPECTIVE STUDY OF THE GERMAN HNPCC CONSORTIUM

C. Engel¹, K. Bucksch¹, S. Zachariae¹, S. Aretz², R. HÄ¼neburg³, S. Holzapfel², E. Holinski-Feder⁴, V. Steinke-Lange⁴, M. Morak⁴, M. von Knebel Doeberitz⁵, M. Kloor⁵, N. Rahner⁶, G. MÄ¼slein⁷, H. K. Schackert⁸, W. Schmiegeler⁹, K. Schulmann¹⁰, R. BÄ¼ttner¹¹, M. Loeffler¹
¹Institute for Medical Informatics, Statistics and Epidemiology, University of Leipzig (Leipzig, Germany), ²Institute of Human Genetics, University of Bonn; Center for Hereditary Tumor Syndromes, University of Bonn (Bonn, Germany), ³Department of Internal Medicine I, University Hospital Bonn; Center for Hereditary Tumor Syndromes, University Hospital Bonn; Institute of Human Genetics, University of Bonn (Bonn, Germany), ⁴Medizinische Klinik und Poliklinik IV, Campus Innenstadt, Klinikum der UniversitÄ¼t MÄ¼nchen; MGZ, Center of Medical Genetics (Munich, Germany), ⁵Department of Applied Tumour Biology, Institute of Pathology, University Hospital Heidelberg; Cooperation Unit Applied Tumour Biology, German Cancer Research Center (DKFZ) (Heidelberg, Germany), ⁶Institute of Human Genetics, Medical School, Heinrich Heine University (DÄ¼sseldorf, Germany), ⁷Center for Hereditary Tumors, HELIOS Klinikum Wuppertal, University Witten-Herdecke (Wuppertal, Germany), ⁸Department of Surgical Research, Technische UniversitÄ¼t Dresden (Dresden, Germany), ⁹Department of Medicine, Knappschaftskrankenhaus, Ruhr-University Bochum (Bochum, Germany), ¹⁰Department of Internal Medicine, Hematology and Oncology, Klinikum Arnsberg (Arnsberg, Germany), ¹¹Institute of Pathology, University of Cologne (Cologne, Germany)

on behalf of the German HNPCC Consortium.

Objective: To estimate age-dependent cumulative incidences for first cancer of any kind, first and metachronous colorectal cancer (CRC), and endometrial cancer (EC) in individuals from families suspected of having Lynch Syndrome (LS), separately for mismatch repair (MMR) gene mutation carriers (LS group), non-mutation carriers from families with MMR deficiency (MSI group), and non-mutation carriers from Amsterdam-positive families without MMR defect (FCCX group).

Patients and Methods: Design: prospective cohort study. Families suspected of having LS based on the Amsterdam-2 criteria and the revised Bethesda guidelines were ascertained in six university centres of the German HNPCC Consortium. Family members were prospectively followed-up within a standardised surveillance program with recommended annual examinations. Data was analysed using the Kaplan-Meier method accounting for the individual age at beginning of prospective observation (left-truncation).

Results: Cumulative incidences for different endpoints and risk groups were as follows:

Endpoint	Group	n	PY	Cumulative incidence, % (95%CI)
any first cancer (at age 60)	LS (<i>MLH1</i>)	103	693	50.1 (23.8-67.4)
	LS (<i>MSH2</i>)	156	1026	62.9 (40.5-76.9)
	LS (<i>MSH6</i>)	47	292	39.4 (0.0-68.0)
	MSI	151	986	22.7 (5.9-36.5)
	FCCX	104	759	8.4 (0.0-19.0)
first CRC (at age 60)	LS (<i>MLH1</i>)	103	693	37.3 (8.1-57.2)
	LS (<i>MSH2</i>)	157	1037	32.8 (6.9-51.6)
	LS (<i>MSH6</i>)	47	292	0.0 (-)
	MSI	151	986	13.0 (0.2-24.2)
	FCCX	104	759	0.0 (-)
metachronous CRC (20y after first CRC)	LS (<i>MLH1</i>)	177	1779	23.2 (5.8-37.4)
	LS (<i>MSH2</i>)	183	1747	19.0 (7.8-28.7)
	LS (<i>MSH6</i>)	50	448	4.3 (0.0-12.3)
	MSI	385	3414	10.2 (0.1-19.2)
	FCCX	121	1399	3.4 (0.0-8.0)
EC (at age 60)	LS (<i>MLH1</i>)	121	751	18.0 (3.7-30.2)
	LS (<i>MSH2</i>)	131	749	33.3 (4.2-53.6)
	LS (<i>MSH6</i>)	42	247	44.4 (0.0-76.9)
	MSI	257	1533	4.6 (0.0-9.6)
	FCCX	114	775	0.0 (-)

(n=number of patients at beginning of follow-up; PY=person-years, CI=confidence interval)

Conclusions: Patients from families without a disease causing MMR gene mutation but signs of MMR deficiency show an elevated cancer incidence compared to FCCX families without any signs of MMR deficiency. Metachronous CRC incidence is high in LS patients. Precise cancer risk estimates are pivotal for genetic counselling and the development of tailored prevention programs. To further improve such incidence estimates, pooled international analyses of prospective cohort data are necessary, which should not involve only LS patients but also individuals from HNPCC families in which no MMR gene mutation could be found.

PP66 - IS UNIVERSAL TUMOR TESTING FOR LYNCH SYNDROME TRULY UNIVERSAL?

S. Kupfer¹, C. Muller¹, W. Barge², J. Chang¹, M. Peterson¹, J. Stoll¹, S. Berera³, G. Wideroff³, D. Sussman³, J. Melson²

¹University of Chicago Chicago, IL, ²Rush University Chicago, IL, ³University of Miami Miami, FL

Background: Universal testing of newly diagnosed colorectal cancers (CRC) is advocated by professional societies and could reduce barriers for the diagnosis of Lynch syndrome among underserved populations. However, the impact of universal tumor screening among racial and ethnic minority populations is not known. Our aim was to compare outcomes of universal CRC tumor screening on the diagnosis of Lynch syndrome in an ethnically diverse multi-center population.

Methods: A retrospective review of CRC patients with tumor testing between 2012 and 2015 at the three academic medical centers in the US was performed. A combined database included demographics, insurance, tumor characteristics, tumor testing, and genetic testing. Demographics and tumor testing were compared using ANOVA for continuous variables and Pearson chi-square for categorical variables.

Results: 594 CRC patients were included. The population included 266 NHW (44.8%), 174 AA (29.2%), 125 Hispanics (21.0%), and 18 Asians (3.0%); comparisons were made between NHW and the two largest minority groups, AA and Hispanics. Demographic characteristics by race/ethnicity are shown in **Table 1**. AA and Hispanics had higher rates of diabetes as well as Medicaid or no insurance. **Table 2** shows tumor testing results. Overall, testing rates were high among all groups with Hispanics having the highest rate (96.8%). Rates of abnormal immunohistochemistry (IHC) were statistically similar among groups. However, AA and Hispanic patients were significantly less likely to be referred for genetics evaluation or to undergo germline genetic testing if they were referred. Overall, the rates of diagnosis of Lynch syndrome were statistically similar among all groups, though AA and Hispanics had relatively lower rates compared to NHW (2.3% AA and 1.0% Hispanic vs 4.1% NHW).

Conclusions: The results of this multi-center study demonstrate that underserved minority populations (AA and Hispanic) undergo universal tumor screening for Lynch Syndrome no less frequently than NHW. However, AAs and Hispanics are significantly less likely to be recommended genetic testing and are less likely to have germline testing performed. These steps rely on provider intervention and/or patient uptake, which could explain these differences. It is possible that less genetic testing among underserved minorities explains lower rates of Lynch syndrome diagnosis in these populations.



PP67 - ESTABLISHING A NON-CENTRALIZED LOW-BUDGET HEREDITARY/FAMILIAL GI CANCER REGISTRY IN IRAN

M. Bahar¹, A. Keshvari², M. S. Fazeli², M. R. Keramati², N. Ebrahimi Daryani³, N. Aletaha³, K. Ayazi⁴

¹Bahar Medical Laboratory, Medical Genetics Tehran, ²Colorectal Surgery, Tehran University of Medical Sciences Tehran,

³Gastroenterology, Tehran University of Medical Sciences Tehran, ⁴Surgery, Shahid Beheshti University of Medical Sciences Tehran

We designed and established a familial/genetic GI cancer registry in form of a coordinated system of nodes (registrars) in three large university hospital centers in Tehran each costing less than \$2,000 to launch. Iran has population of over 80 million with \$1082 health expenditure per capita. Health insurance coverage and social security are yet to be fully integrated. However, private specialist as the first line of health care process is affordable and accessible to a considerable percentage of the population.

Before establishing a registry in this landscape, addressing a number of complicating factors came apparent: (a) complex sets of expectations and dispositions of specialists in each institutes, (b) inadequate awareness of the importance of registries in management of cancer syndromes, (c) lack of appropriate and practical guidelines and (d) a very limited available budget. Moreover, we ran a problem assessment procedure to identify the issues which impeded the expansion of a preexisting registry-like service. Two categories of problem were (a) the practitioners' desire of to follow their own patients and (b) inadequate awareness and recognition.

In our circumstances, in spite of knowing the benefits of centralized care in management of cancer syndromes, we found it less likely to succeed. Therefore, first with the help of multi-disciplinary tumor boards in each hospital we tailored practical guidelines for screening and surveillance of cancer syndrome patients and their at-risk family members. We established cancer syndrome counseling units in each hospital providing settings for risk assessment, genetic counseling and communication. We designed and provided a computer app capable of depicting pedigree, medical record keeping and managing follow-up processes by using text messages, prerecorded voice messages and links to telecommunication social apps, e.g. Telegram®. Also, we recruited and trained a coordinator for the registry.

At this point, in addition to managing our own patients, we have approached and oriented private practitioners. To avoid previous dismay, after counseling and genetic work up with the consent of the patient, we refer them and their at-risk family members back to the specialist whom had addressed them to the registry. So far, we have registered more than 50 families and the compliance and impact appear promising. Our experiment could be considered a model for establishing registries in similar landscapes.

PP68 - PRELIMINARY EXPERIENCE ON TESTING HEREDITARY GASTROINTESTINAL TUMOR RISK USING MULTI-GENE PANEL

J. Ji¹, A. Zhou¹, J. V. D. Akker¹, K. Smith¹, R. O'Connell¹, S. Kim¹, A. Leon¹, J. D. Keen-Kim¹, T. Sittler¹

¹Color Genomics Burlingame, CA, USA

We have tested 3,311 individuals using a 30-gene panel for Hereditary Cancer Risk (the Color Test) including 11 genes associated with increased risk for gastrointestinal cancer. In this cohort, 415 pathogenic or likely pathogenic variants (319 female and 96 male) from 30 genes were identified and reported. The overall proportion of individuals with a pathogenic or likely pathogenic variant (positive rate) in genes associated with hereditary gastrointestinal tumor risk (*MLH1*, *MSH2*, *MSH6*, *PMS2*, *MUTYH*, *APC*, *EPCAM*) was 3.8% (127/3311). However, pathogenic or likely pathogenic variants were not identified in this cohort for the *CDH1*, *STK11*, *SMAD4*, *BMPR1A*, and *PTEN* genes. Among the 127 individuals who received a positive result for gastrointestinal hereditary tumor risk, 51 (40.2%, 51/127) had one pathogenic or likely pathogenic variant detected in *MUTYH*, while three individuals had two concurrent pathogenic or likely pathogenic variants detected in *MUTYH*. In addition, 41 (32.3%, 42/127) individuals had the *APC* c.3920T>A (I1307K) common variant detected, which is known to have lower penetrance and different screening recommendations than other *APC* pathogenic variants. The majority of individuals in this cohort self-reported as Caucasian (64.9%, 2148/3311) and female (82.2%, 2721/3311), indicating a need in the broader community for better outreach and education to minorities and males. Additionally, about a quarter of individuals who received positive results from the 30 gene panel were under the age of 40, indicating the importance of increasing awareness and uptake of genetic testing within the younger population, as well as within the male sector, at an age for which preventative care is more relevant. Taken together, these data reinforce the continued need to increase awareness and broaden access to Hereditary Cancer Risk testing within the general population.

PP69 - ENDOSCOPIC SUBMUCOSAL DISSECTION OF A LARGE NEOPLASTIC LESION AT ILEORECTAL ANASTOMOSIS IN A PATIENT WITH FAMILIAL ADENOMATOUS POLYPOSIS

T. Nakajima¹, S. Sansone², Y. Saito¹

¹Endoscopy Division, National Cancer Center Hospital Tokyo, Japan, ²NIHR Nottingham Digestive Diseases Biomedical Research Unit, Nottingham University Hospitals NHS Trust and University of Nottingham Nottingham, United Kingdom

Background: Ileorectal anastomosis (IRA) is one of the surgical treatment options for patients with familial adenomatous polyposis (FAP); however, if cancer occurs in the remnant rectum, further surgical resection should be offered. Endoscopic submucosal dissection (ESD) may remove gastrointestinal neoplasias even with severe associated fibrosis [1-3]. We report the first case of ESD for a large neoplasia located in the remnant rectum after total colectomy in a FAP patient.

Case report: A 33-year-old woman with FAP underwent total colectomy with ileorectal anastomosis (IRA) at the age of 19. Last endoscopic surveillance of the rectal stump was performed in 2009 due to patient's convenience. In 2016 she presented with 0-Is+IIa lesion, measuring 75mm, occupying the whole dog-ear portion of the rectum and involving the IRA. Following discussion in outpatient clinic, patient preferred ESD attempt over surgery.

ESD was performed by an expert endoscopist using a gastroscope (GIF Q260J; Olympus Co., Ltd.) attached to a small-caliber-tip transparent hood (short ST hood; Fujifilm Co., Ltd.). The VIO 300 D (ERBE, Tubingen, Germany) was used as an electrosurgical generator. 10% glycerol, small amount of indigocarmine and 0.4 % sodium hyaluronate solution were injected into the submucosal layer. Jet B knife (XEMEX Co., Ltd) and IT knife-nano (Olympus Co., Ltd.) were adopted to cut the submucosal layer. Severe fibrosis was noted near the IRA site, with two staples being evident within the neoplasia, interfering with the ESD. Excessive fibrosis was handled with a Hook knife (Olympus Co., Ltd.) by dissecting under direct visualization of the cutting line ([video](#)). In this case, in spite of very difficult access to the lesion and severe fibrosis, ESD was safely performed using different types of knife. *En-bloc* resection was achieved without any complications in 193 min. Histopathology showed high-grade adenoma without submucosal invasion. Tumor free margins were also demonstrated. No stricture and no change in defecation function were noted at clinical follow-up.

Conclusion: ESD may provide safe and effective resection of neoplasias with severe associated fibrosis, such as peri-anastomotic lesions. Technical challenges may be overcome by expert endoscopist by means of equipment selection and careful resection under direct visualization of the cutting line.

References

1. Repici A, Hassan C, De Paula Pessoa D, et al. *Endoscopy*. 2012; 44: 137–50.
2. Sakamoto T, Saito Y, Matsuda T, et al. *Surg Endosc*. 2011;25:255–60.
3. Saito Y, Uraoka T, Matsuda T, et al. *Gastrointest Endosc*. 2007; 66: 966–73.

Legend for [video](#)

75 mm 0-Is+IIa lesion, located at ileorectal anastomosis in a FAP patient. Removed by ESD using Jet B knife and IT knife-nano. Severe fibrosis and two staples noted within the lesion. Handled with Hook knife. Histopathology revealed a curative resection.

PP70 - NEXT-GENERATION SEQUENCING IN FAMILIAL BREAST CANCER PATIENTS FROM LEBANON

F. Al-Mulla¹, A. Megarbane²

¹Molecular Pathology Kuwait, ²Genetics Beirut

Background: Familial breast cancer (BC) represents 5 to 10% of all BC cases. Mutations in two high susceptibility *BRCA1* and *BRCA2* genes explain 16–40% of familial BC, while other high, moderate and low susceptibility genes explain up to 20% more of BC families. The Lebanese reported prevalence of *BRCA1* and *BRCA2* deleterious mutations (5.6% and 12.5%) were lower than those reported in the literature.

Methods: In the presented study, 45 Lebanese patients with a reported family history of BC were tested using Whole Exome Sequencing (WES) technique followed by Sanger sequencing validation.

Results: Nineteen pathogenic mutations were identified in this study. These 19 mutations were found in 13 different genes such as: *ABCC12*, *APC*, *ATM*, *BRCA1*, *BRCA2*, *CDH1*, *ERCC6*, *MSH2*, *POLH*, *PRF1*, *SLX4*, *STK11* and *TP53*.

Conclusions: In this first application of WES on BC in Lebanon, we detected six *BRCA1* and *BRCA2* deleterious mutations in seven patients, with a total prevalence of 15.5%, a figure that is lower than those reported in the Western literature. The p.C44F mutation in the *BRCA1* gene appeared twice in this study, suggesting a founder effect. Importantly, the overall mutation prevalence was equal to 40%, justifying the urgent need to deploy WES for the identification of genetic variants responsible for familial BC in the Lebanese population.

PP72 - CLINICOPATHOLOGICAL CHARACTERISTICS OF INITIAL COLORECTAL CANCER AND METACHRONOUS COLORECTAL CANCER DEVELOPMENT IN JAPANESE MISMATCH REPAIR GENE MUTATION CARRIERS.

M. Miguchi¹, T. Konishi², M. Arai³, T. Yamaguchi⁴, K. Tanakaya⁵, T. Nomizu⁶, K. Yamashita⁷, T. Hinoi⁸, N. Matsubara⁹, T. Nagasaka¹⁰, T. Mori¹⁰, K. Kumamoto¹¹, M. Kakuta¹², H. Ishida¹³, K. Akagi¹²

¹Department of Surgery, Hiroshima City Asa Citizens Hospital, Hiroshima, Japan. Hiroshima Japan, ²Gastroenterological Center, Department of Gastroenterological Surgery, Cancer Institute Hospital, Japanese Foundation for Cancer Research Tokyo, Japan, ³Clinical Genetic Oncology, Cancer Institute Hospital of Japanese Foundation for Cancer Research Tokyo, Japan, ⁴Department of Surgery, Tokyo Metropolitan Cancer and Infectious Diseases Center Komagome Hospital Tokyo, Japan, ⁵Department of Surgery, National Hospital Organization Iwakuni Clinical Center Yamaguchi, Japan., ⁶Department of Surgery, Breast Cancer Center, Familial Tumor Clinic, Hoshi General Hospital Fukushima, Japan, ⁷Department of Gastroenterology and Hepatology, Sapporo Medical University Sapporo, Japan, ⁸Department of Gastroenterological and Transplant Surgery, Applied Life Sciences, Institute of Biomedical & Health Sciences, Hiroshima University Hiroshima, Japan., ⁹Department of Surgery, Hyogo College of Medicine Nishinomiya, Japan., ¹⁰Department of Gastroenterological Surgery, Okayama University Graduate School of Medicine, Dentistry and Pharmaceutical Sciences Okayama, Japan, ¹¹Fukushima Medical University Fukushima, Japan, ¹²Div. Molecular Diagnosis & Cancer Prevention Saitama Cancer Center Saitama, Japan, ¹³Department of Digestive Tract and General Surgery, Saitama Medical Center, Saitama Medical University Kawagoe, Japan

Purpose

To identify the characteristics of initial colorectal cancer (CRC) and factors predicting metachronous CRC development in patients with Lynch syndrome (LS).

Methods

Clinicopathological characteristics were compared for CRC developing first in the colon or rectum, and factors predicting metachronous CRC development were identified using a retrospective cohort of Japanese mismatch repair gene mutation carriers. Furthermore, in order to investigate the factors predicting metachronous CRC development, clinicopathological characteristics were also compared between patients with metachronous CRC and those without metachronous CRC, among 105 carriers whom segmental colectomies were performed for. Cumulative risks of metachronous CRC were calculated using the Kaplan-Meier method, and the log-rank test was used to compare risks between the two groups.

Results

Of 176 mismatch repair genes mutation carriers, 82 had *MLH1* mutations, 71 had *MSH2* mutations, 17 had *MSH6* mutations, five had *PMS2* mutations, and one had *MLH1* and *MSH2* mutation. The median age at diagnosis for initial CRC was 44 years (range: 17–93). One hundred forty three (81.2%) and 33 (18.8%) carriers exhibited cancer in the colon or rectum first, respectively. No significant differences were observed in clinicopathological characteristics. Thirty five (33.3%) patients developed metachronous CRC over a mean follow-up of 9.4 years (95%CI: 7.0-12.2). The cumulative risk percentages of metachronous CRC were 27.1% and 73.6% at 10 and 20 years after surgery, respectively. Furthermore, the rates of metachronous CRC might be different, based on pathogenic mismatch repair genes and lymphovascular invasion of initial CRC.

Conclusions

Our findings provided important insights into the clinicopathological characteristics of CRC developing first in the colon or rectum and the role of mismatch repair genes mutations on metachronous CRC risk.

PP74 - HEREDITARY COLORECTAL CANCER WITH DIAGNOSIS AFTER AGE 50 – CHARACTERISTICS OF THE “LATE ONSET” PHENOTYPE

C. Therkildsen¹, S. Ladelund¹, L. Lindberg¹, M. Nilbert¹

¹HNPCC-register, Copenhagen University Copenhagen

Young age at onset is a feature of hereditary cancer. Yet, in a significant number of families with seemingly hereditary colorectal cancer, tumors develop after age 50. The national Danish HNPCC-register defines families with histologically verified colorectal cancer in 3 family members, 1 of whom is a first-degree relative of the other 2, no colorectal cancer below age 50, and FAP excluded as “late onset” colorectal cancer.

We have reviewed the 439 late onset colorectal cancer families identified in the HNPCC-register, based on a population of 5.7 million. Among these, 18 (4%) families were found to have Lynch syndrome with MSH6 mutations in half of the families. In the remaining 424, genetically undefined, families, 2028 individuals developed 2332 tumors, including 1552 colorectal cancers diagnosed at a median age of 69 years. Tumor location was within the right colon in 30%, the left colon in 33% and in the rectum in 37%. The 780 extra-colonic cancers, 78% of which were diagnosed above age 50, were predominantly breast cancer, prostate cancer and lung cancer.

We conclude that the “late onset” family pattern of colorectal cancer may contain occasional Lynch syndrome families, but besides these cases mimics sporadic colorectal cancer as regards age at onset and tumor location. Further characterization of the cumulative risk of colorectal cancer, development of synchronous and metachronous cancer and potential genetic causes will be addressed.

PP77 - LYNCH SYNDROME NETWORK IN LOMBARDY REGION

M. G. Tibiletti¹, L. Bertario², R. Labianca³, M. Bersani⁴

¹Dpt of Pathology, Ospedale di Circolo, ASST Settelaghi Varese, ²Istituto Nazionale Tumori Milano, ³Scientific coordinator Steering and Executive Committee of Oncology Lombardy network (ROL), Director of Cancer Center Ospedale Papa Giovanni XXIII Bergamo, ⁴Regional representative of Lombardy oncology network Milano

Identifying Lynch Syndrome (LS) helps to prevent and to reduce cancer morbidity and mortality in affected families. However traditional use of clinical criteria such as Amsterdam and Bethesda Guidelines, as well as genetic prediction models have been criticized for the not optimal sensitivity.

Studies evaluating the efficacy of universal molecular testing of colorectal cancers (CRC) revealed that as many as 28% of individuals with LS are not identified using clinical criteria .

Different platforms should be used for LS universal testing including germline molecular analysis, somatic microsatellite instability (MSI), immunohistochemical analysis (IHC) on colorectal cancers (CRC) and endometrial cancers.

We report the first Italian organized experience to start up universal LS screening in Lombardy Region; the project was centrally discussed and supported by Oncology Lombardy Network (ROL4)

In order to ascertain the institutions in which LS diagnosis and patient care is ongoing in Lombardy, a specific survey was centrally performed: 31 institutions affirm to have organized services for identification and care of inherited colorectal cancers.(see figure1). In 13 Centers a specific Cancer Genetics Counselling service is working while the remaining 12 institutions referred to outside Genetic Centers. The most of Centers set up a multidisciplinary approach for high risk patient care.

As all pathology departments in Lombardy are able to routinely perform IHC testing and taking into account the high effectiveness and the low cost (20 euros) of IHC for four MMR proteins, the protocol of universal screening for LS using IHC on all surgical samples of new diagnosed CRC was centrally established. After suitable training for MMR IHC testing organized for all Pathologists, from September 2015, in 55 institutions the protocol of universal screening on all newly surgical samples of CRC was activated .

Currently 38 centers routinely perform IHC testing and 22 of them have sent preliminary results on 1840 CRC (20% of all CRC diagnosed in Lombardy region) showing that 14.2% (261/1840) were defective of almost one MMR protein. MLH1-PMS2 defect was diagnosed in 72% of cases, MSH2-MSH6 loss, MSH6 and PMS2 loss alone were respectively observed in 13.8%, 7.4% and 7.8% of defective CRC.

Considering that the majority of MLH1-PMS2 defective CRC are sporadic MMR defective CRC, we estimate a rough LS prevalence of 6.0%

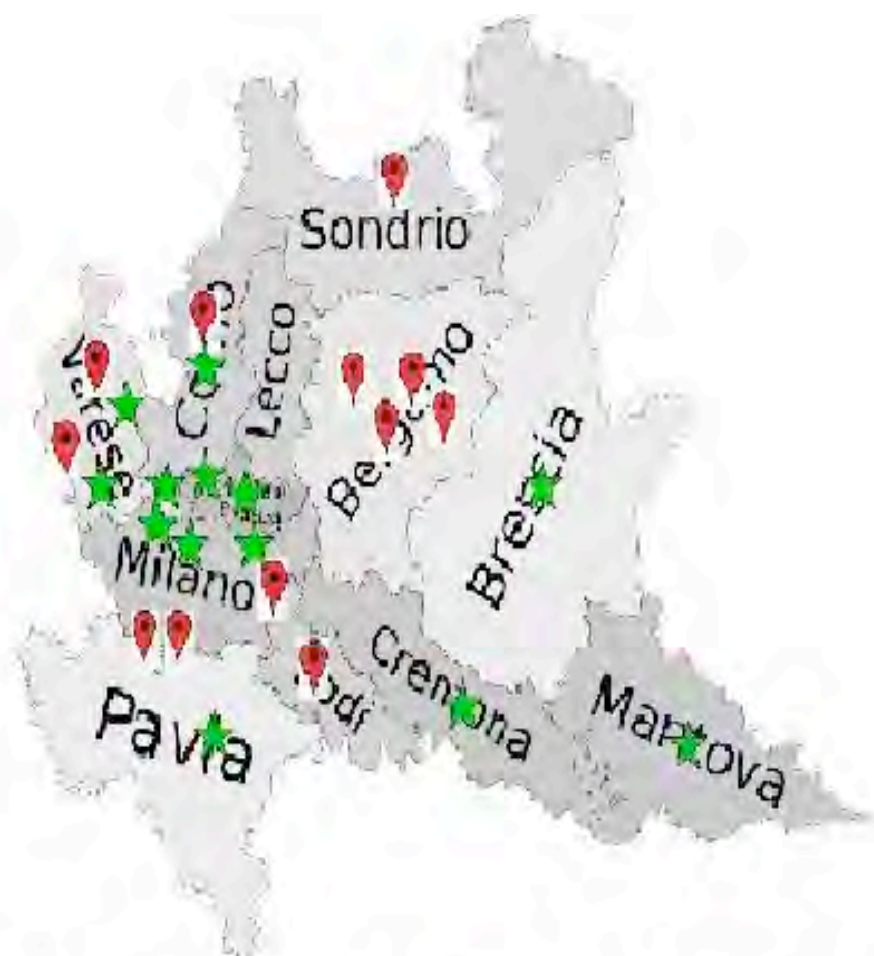

Figure 1: Green symbols indicate Centers with Cancer Genetic Counselling Services . Red symbols indicate Center referred to outside Cancer Genetic Counselling Services

PP78 - LYNCH SYNDROME ASSOCIATED TO A RECURRENT CLASS 5 VARIANT IN THE 3'UTR OF THE MSH6 GENE

A. Viel¹, A. M. Chiaravalli², G. Cini¹, I. Carnevali², M. Quaia¹, L. Libera³, M. T. Ricci⁴, F. Rivieri⁵, R. Maestro¹, E. Pin⁶, M. G. Tibiletti²

¹Functional onco-genomics and genetics, CRO Aviano, National Cancer Institute, Aviano (PN), Italy, ²Unit of Pathology, Ospedale di Circolo, Varese, Italy, ³Department of Medicine and Surgery, Insubria University Varese, Varese, Italy, ⁴Hereditary Digestive Tract Tumours Unit, Department of Preventive and Predictive Medicine, Fondazione IRCCS Istituto Nazionale dei Tumori, Milan, Italy, ⁵Medical Genetic Service, S. Chiara Hospital, Trento, Italy, ⁶Affinity Proteomics, School of Biotechnology, KTH - Royal Institute of Technology, Solna, Sweden

Ten unrelated families have been identified carrying the *MSH6* c.*(23_26)dupAGTT variant, which is localized on the 3'UTR of the gene. Using a mutation screening strategy including different methods (Sanger and NGS sequencing, MLPA and FISH), we did not identify other clear-cut pathogenic mutations in the *MSH6/MSH2/EPCAM* genes, suggesting a causative role of this atypical variant.

All but one proband originated from the same geographic area (Varese/Como) and all shared a common haplotype. This variant was absent in healthy controls and never detected in patients with different origin.

Further evaluation of 26 additional family members showed almost perfect co-segregation of the variant with a severe Lynch phenotype, which is quite unusual for *MSH6* gene. Of note, beside colorectal cancer, many tumors of endometrium, small bowel, biliary tract, ovary, stomach, pancreas, bladder and skin were present, often as multiple tumors (2-6 tumors in 16 carriers) and with very early onset (23-40 years in 12 carriers). All 28 analyzed malignant tumors displayed MSI-H, along with loss of the MSH2 and MSH6 proteins. Moreover 12 out of 12 tested tumors also failed to show MSH3 protein. Incorporation of the segregation and tumor data into a multifactorial likelihood model, according to the InSiGHT rules, unequivocally indicated a posterior probability of pathogenicity >0.99, allowing attribution of Class 5. This should warrant the c.*(23_26)dupAGTT test in a diagnostic setting, including predictive gene testing in healthy family members.

However, the true pathogenic role of this 3'UTR variant is still questionable, because it is not supported by additional data. In fact, we observed retention of the wild type *MSH6* allele in 7/7 tumors and absence of allelic expression imbalance in both lymphoblastoid cell lines and tumor tissues. These data highlight how problematic is interpretation of the functional significance of the non-coding sequence variants of MMR genes and their role in Lynch syndrome.

Recently, NGS sequencing of a gene panel including mismatch repair genes has displayed the presence of somatic *MSH2* truncating mutations in 4 out of the 5 tested tumors, which can be interpreted as second hits. They may be an indication of a constitutional cryptic pathogenic variant of the *MSH2* gene, linked to the c.*(23_26)dupAGTT *MSH6* variant on chromosome 2 of all carriers, but undetectable by the analytical methods used until now.

This study was a collaboration among members of AIFEG.

PP81 - CONSTITUTIONAL MISMATCH REPAIR DEFICIENCY: ON THE SPOT DIAGNOSIS?

M. Suerink¹, T. Potjer¹, B. Versluijs², S. ten Broeke¹, C. Tops¹, K. Wimmer³, M. Nielsen¹

¹Clinical Genetics Leiden, ²Pediatric Hematology Utrecht, ³Human Genetics Innsbruck

Constitutional mismatch repair deficiency (CMMRD), a recessively inherited cancer syndrome caused by bi-allelic germline mutations in one of the mismatch repair genes, confers a high risk of malignancies in childhood. The CMMRD phenotype overlaps with that of neurofibromatosis type 1 (NF1), since many patients have multiple café-au-lait macules (CALMs) and other NF1 signs, but no germline NF1 mutations.

We report of a case of a healthy six-year-old girl who fulfilled the diagnostic criteria of NF1 with >6 CALM and axillary freckling. Since molecular genetic testing was unable to confirm the diagnosis of NF1 or Legius syndrome and the patient was a child of consanguineous parents, we then tested for CMMRD and found a homozygous PMS2 mutation that impairs MMR function.

Current guidelines advise testing for CMMRD only in cancer patients. However, this case illustrates that including CMMRD in the differential diagnosis in suspected sporadic NF1 without causative NF1 or SPRED1 mutations may facilitate identification of CMMRD prior to cancer development. We discuss the advantages and potential risks of this CMMRD testing scenario.

PP83 - COMMON GENETIC VARIATION NEAR CDKN1A IS ASSOCIATED WITH COLORECTAL CANCER SUSCEPTIBILITY IN MALE PMS2 MUTATION CARRIERS

S. W. ten Broeke¹, F. A. Elsayed², L. Pagan¹, M. J. Oolderode-Berends³, E. Gomez Garcia⁴, H. J. Gille⁵, L. P. van Hest⁵, T. G. Letteboer⁶, L. E. van der Kolk⁷, A. R. Mensenkamp⁸, T. A. van Os⁹, L. Spruijt⁸, B. J. Redeker⁹, M. Suerink¹, Y. J. Vos³, A. Wagner¹⁰, J. T. Wijnen¹, C. M. Tops¹, T. van Wezel¹, M. Nielsen¹

¹Clinical Genetics - Leiden University Medical Center Leiden, ²Pathology - Leiden University Medical Center Leiden, ³Clinical Genetics - University Medical Center Groningen Groningen, ⁴Clinical Genetics - Maastricht University Medical Center Maastricht, ⁵Clinical Genetics - VU Amsterdam Amsterdam, ⁶Clinical Genetics - University Medical Center Utrecht Utrecht, ⁷Clinical Genetics - The Netherlands Cancer Institute Amsterdam, ⁸Clinical Genetics - Radboud University Medical Center Nijmegen, ⁹Clinical Genetics - Academic Medical Center Amsterdam, ¹⁰Clinical Genetics - Erasmus Medical Center Rotterdam

Objective Lynch syndrome (LS) patients are at high risk of developing colorectal cancer (CRC) and show high phenotypic variability. This variability might in part be explained by common susceptibility loci identified in Genome Wide Association Studies (GWAS). Previous studies focused almost exclusively on MLH1, MSH2 and MSH6 carriers, but produced conflicting results. Here we investigate the role of GWAS SNPs in PMS2 carriers.

Design A case-control study was performed in 521 PMS2 carriers (125 CRC cases) assembled from Dutch family cancer clinics. The cohort was genotyped for 26 candidate GWAS SNPs; rs6687758, rs6691170, rs10936599, rs1321311, rs16892766, rs6983267, rs10795668, rs3802842, rs3824999, rs4444235, rs9929218, rs4939827, rs12953717, rs10411210, rs961253, rs4925386, rs1569686, rs2736100, rs1800734, rs1799945, rs1048943, rs4934683, rs1800562, rs11169552, rs7136702, rs4779584. Hazard ratios (HRs) were calculated using a weighted cox regression analysis to correct for ascertainment bias.

Results We found no evidence of an association between CRC and cumulative number of risk alleles (HR=1.05, 95%CI: 0.97-1.10). Male PMS2 carriers of the rs1321311 CA/CC genotype were at an increased risk of CRC (HR=2.81 (95%CI: 1.21-3.4, p=0.008). Moreover, the combination of rs1321311 with rs7136702 led to an increased HR for each additional risk allele of 1.58 (95% CI: 1.18-1.91, p=0.0010), a finding that also holds after correction for multiple testing (p<0.0015).

Conclusion Interestingly, two SNPs (rs3802842 and rs16892766) previously found to increase risk in MLH1 carriers do not appear to modify risk in this cohort. This, together with established lower penetrance and phenotypic variability, raises the question of whether PMS2-associated LS should be considered a separate disease entity.

PP84 - ANNUAL COLONOSCOPY COULD NOT PREVENT SURGERY FOR COLORECTAL CANCER IN A FAMILY WITH MLH1 AND MSH2 MUTATION CARRIERS.

K. Tanakaya¹, Y. Mushiake¹, T. Kunitomo¹, F. Taniguchi¹, I. Yasuhara¹, M. Utsumi¹, T. Arata¹, K. Katsuda¹, H. Aoki¹, H. Takeuchi¹, C. Tamura², K. Matsuda², N. Katsumata², Y. Furukawa³, K. Sugano⁴, H. Ishikawa⁵, H. Ishida⁶

¹Department of Surgery, National Hospital Organization, Iwakuni Clinical Center Iwakuni, ²Department of genetics, National Hospital Organization, Iwakuni Clinical Center Iwakuni, ³Division of Clinical Genome Research, Advanced Clinical Research Center, Institute of Medical Science, University of Tokyo Tokyo, ⁴Oncogene Research Unit/Cancer Prevention Unit, Tohigi Cancer Center Utsunomiya, ⁵Department of Molecular-Targeting Cancer Prevention, Kyoto Prefectural University of Medicine Kyoto, ⁶Department of Digestive Tract and General Surgery, Saitama Medical Center, Saitama Medical University Kawagoe

Backgrounds: While colonoscopic surveillance (CS) at 1- to 2-year intervals has proven to be effective in reducing the incidence of colorectal cancer (CRC) and CRC-associated mortality in patients with Lynch syndrome (LS), the optimal interval of CS to avoid CRC surgery has not yet been determined. In this study, we evaluated whether annual CS could help Japanese patients with LS avoid CRC surgery.

Methods: The clinical information from 24 Japanese proven mutation carriers (*MLH1* gene mutations, n=22; *MSH2* gene mutations, n=2) who underwent annual CS was retrospectively collected and analyzed.

Results: The patient group consisted of 10 (41.6%) men (median age, 66.5 years [range, 44–80 years]) and 14 (58.4%) women (60.5 years [30–87 years]). Eight patients had a history of surgery or endoscopic resection for CRC. A total of 91 annual CS examinations were performed and 60 tumors were detected. Histological examinations revealed that 44 (73.3%) tumors were low-grade adenomas, 5 (8.3%) were hyperplastic polyps, one (1.7%) was a serrated adenoma, one (1.7%) was a tubulovillous adenoma, 5 (8.3%) were high-grade adenomas and 3 (5.0%) were submucosal adenocarcinomas. Twenty-two of the 44 adenomas (50%) were located in the proximal colon; the other 22 (50%) were located in the distal colon. Of the 5 high-grade adenomas and 3 adenocarcinomas, 6 (75%) were located in the proximal colon, while 2 (25%) were located in the distal colon. Twenty-seven of the 44 (72%) adenomas were protruded-type and 17 (28%) were flat-type. The median tumor size was 5 mm (range, 2–12 mm). One of the 3 submucosal carcinomas, was treated by endoscopic resection, while two were treated by surgery. According to AJCC system, all of the 3 carcinomas were estimated to be stage I.

Conclusion: If patients with LS wish to avoid surgery at all costs, it might be necessary to perform CS more than once a year.

PP86 - A POTENTIAL CHEMOPREVENTATIVE FOOD FOR FAMILIAL ADENOMATOUS POLYPOSIS: THE AUSFAP STUDY

F. Macrae¹, A. Boussioutas², B. Flanders¹, A. Spigelman³, M. Appleyard⁴, D. Cameron⁵, J. M. Clarke⁶, T. Lockett⁷

¹Colorectal Medicine and Genetics, Royal Melbourne Hospital Parkville, Melbourne VIC 3050, ²Department of Gastroenterology, Royal Melbourne Hospital Parkville, Melbourne VIC 3050, ³St Vincent's Hereditary Cancer Clinic, The Kinghorn Cancer Centre Darlinghurst, Sydney NSW 2010, ⁴Department of Gastroenterology and Hepatology, Royal Brisbane and Women's Hospital Herston, Brisbane QLD 4028, ⁵Department of Gastroenterology and Clinical Nutrition, Royal Children's Hospital Parkville, Melbourne VIC 3052, ⁶CSIRO Health and Biosecurity Adelaide SA 5000, ⁷CSIRO Health and Biosecurity North Ryde NSW 2113

Introduction

Diets high in fibre may protect from colorectal cancer (CRC) by increasing production of butyrate from colonic fermentation. Dietary butyrylated high amylose maize starch (HAMSB) enhances delivery of butyrate to the colon of humans¹ and this increase in butyrate levels in the large bowel may protect from CRC². Individuals with Familial Adenomatous Polyposis (FAP) have an inherited germ-line APC mutation which results in the development of hundreds of colonic adenomas. FAP is a well-recognised model of sporadic colorectal carcinogenesis. High amylose maize starch may be used as a strategy to reduce the development of adenomatous polyps in this population.

An Australian multi-state Cancer Council research grant was awarded to undertake a clinical trial to investigate the potential chemoprotective effect of HAMSB on polyposis in FAP participants.

Aims of the study

(1) Assess the effect of HAMSB on polyp burden in (i) a defined area after polyp clearance at endoscopy (ii) another area where residual small polyps are left in situ; and (iii) generally throughout the large bowel. The two areas are defined by endoscopic tattoos and monitored for polyp growth or regression after baseline.

(2) Determine the mechanisms of action of HAMSB on molecular characteristics of biopsies from polyps and mucosa.

Methods

AusFAP is a double blind, randomised, cross-over placebo controlled trial. Participants with intact colons, ileo-rectal anastomoses and pouches are eligible provided they have had a history of adenomas preceding colectomy and post colectomy surgery. After baseline endoscopy participants consume either HAMSB or placebo (low amylose maize) starch, then undergo endoscopic examination before consuming the alternate starch. The endoscopies are recorded, and polyps and mucosa biopsied. Blood and faecal samples and details of the participants' diet and bowel symptoms are also collected. The sample size required is 64. To date 75 participants have been enrolled in the trial (with five further potential participants awaiting public hospital endoscopy waiting list allocation) and 17 have withdrawn prior to their completion of the study. A panel of the study clinical investigators are reviewing the videos (blinded) independently and grade the number of polyps based on fixed criteria.

References

1. Clarke, JM et al. *Am J Clin Nutr* 2011;94:1276–83
2. Humphreys, KJ et al. *Cancer Prev Res* 2014;7:786-795

PP87 - YIELD OF UNIVERSAL TESTING FOR MISMATCH REPAIR PROTEIN DEFICIENCY IN 2077 COLORECTAL CARCINOMAS

C. Rosty¹, G. Miller¹, M. Bettington¹, I. Brown¹

¹Envoi Pathology Brisbane

Introduction: Lynch syndrome is the most common cause of inherited colorectal carcinoma (CRC). Current surveillance guidelines are effective at decreasing the morbidity and mortality of Lynch syndrome-associated cancers, however many cases are still missed. Among various screening strategies, testing all newly diagnosed CRC for mismatch repair (MMR) protein deficiency, known as universal testing, has recently emerged as the preferred approach to identify potential Lynch syndrome individuals, who then require genetic counselling.

Materials and methods: All newly diagnosed CRCs from initial biopsy or surgical resection specimen were screened for MMR protein expression by immunohistochemistry. A 2-step approach was used: PMS2 and MSH6 testing followed by the testing of the respective MMR protein partner if one of the proteins is lost. We retrospectively searched our pathology database for MMR protein expression results across a 5-year period (2012-2016) when universal testing was performed. Clinical and pathological data were extracted from the pathology report.

Results: 2077 consecutive CRCs were tested for MMR protein expression. Mean age at diagnosis was 68.4 years (range 18-96). MMR protein deficiency was identified in 404 cases (19.5%). The detailed results of the abnormal immunohistochemical patterns are displayed in the table, stratified by age groups.

MMR protein loss pattern	All ages n=2077	<50 years n=191	50-59 years n=289	60-69 years n=535	>70 years n=1062
MLH1/PMS2	364	13	11	35	305
MSH2/MSH6	21	1	1	7	12
MSH6	12	3	3	4	2
PMS2	7	2	0	2	3

The vast majority of CRC with MLH1/PMS2 loss were diagnosed in patients older than 70 years (83.8%), most of them are likely to be secondary to sporadic *MLH1* methylation. In 8 cases with MLH1/PMS2 loss, loss of MSH6 expression was also present. MMR protein deficiency patterns suggestive of a defect in MSH2, MSH6 or PMS2 comprised 40 cases, of which 34 were found in individuals aged 50 years or older. CRCs with MSH2/MSH6 loss were most commonly found in patients older than 70 years (57%).

Conclusions: Universal testing for MMR protein deficiency in CRC identifies abnormal patterns of expression suggestive of Lynch syndrome in all age groups, including many in those excluded by current guidelines. Further studies are needed to demonstrate the actual rate of Lynch syndrome individuals identified from this initial screening.

PP89 - PROGNOSTIC OR PREDICTIVE IMPACTS OF COLORECTAL CANCERS WITH LYNCH SYNDROME BY THE ADMINISTRATION OF 5-FU-BASED ADJUVANT CHEMOTHERAPY

K. Akagi¹, M. Kakuta¹, H. Ishida², S. Mori³, T. Nagasaka³, N. Matsubara⁴

¹Saitama prefectural cancer center Saitama, ²Saitama medical school Saitama, ³Okayama University Okayama, ⁴Amagasaki Central Hospital Amagasaki

Background:

Approximately 15% of colorectal cancers (CRCs) develop because of defective function of DNA mismatch repair (MMR) system. Although the association of MMR status on CRC recurrence especially impact of 5-FU-based adjuvant chemotherapy on recurrence were studied, results were sometimes contradictory, partly because sporadic and Lynch syndrome (LS) were not separately examined in the analysis of MMR deficient (dMMR) CRC. Thus, the impact of adjuvant chemotherapy on Lynch syndrome was no fully understood.

Aim:

To examine the survival benefit of 5-FU-based adjuvant chemotherapy on Lynch syndrome using the registry database collected from multi institutions.

Methods:

We examined 53 cases of stage II and III LS CRC patients, all verified by the genetic test of MMR genes including *MLH1*, *MSH2*, *MSH6*, and *PMS2*. Association of 5-FU-based treatment vs surgery alone on stage II and III LS CRC patients with clinicopathologic and recurrence covariates was determined using χ^2 or Fisher Exact or Wilcoxon rank-sum tests. Disease-free survival (DFS) and overall survival (OS) were analyzed using univariate and multivariate Cox models.

Results:

Among the 53 stage II and III LS CRC patients, 3 patients showed recurrence and 2 were stage 2 and one was stage III. One patient recurred during the 6 month of post-operative adjuvant chemotherapy period. Eight patients deceased and among them 2 were due to the CRC recurrence. One patient deceased due to the LS related cancer (brain tumor). Five year OS of LS patients with adjuvant chemo vs surgery alone were 96.2% and 96.3%, respectively. Five year DFS of LS patients with adjuvant chemo vs surgery alone were 96.2% and 92.6%, respectively. In the stage III LS patients there was no difference between 5-FU-based adjuvant treatment vs surgery alone in both DFS and OS.

Conclusions:

Most studies have not assessed whether or not the prognostic or predictive impacts of CRCs with LS by the administration of 5-FU-based adjuvant chemotherapy. Our study shows that stage III CRC patients with LS may not benefit from 5-FU-based adjuvant chemotherapy, partly because OS and DFS were so favorable in such LS CRC patients.

PP90 - IMPACT OF THE TYPE OF SURGERY AT THE TIME OF DIAGNOSIS OF COLORECTAL CANCER IN PATIENTS WITH LYNCH SYNDROME

M. Navarro¹, M. Pineda¹, S. Iglesias¹, M. Salinas¹, E. Grau¹, A. Solanes¹, A. TeulÃ©¹, C. LÃ©izaro¹, F. RodrÃ©guez-Moranta², A. Soriano², J. Brunet¹, G. CapellÃ©¹

¹Hereditary Cancer Program, Catalan Institute of Oncology L'Hospitalet, Barcelona, ²Gastroenterology Department, Bellvitge Hospital L'Hospitalet, Barcelona

Introduction and objectives

Lynch syndrome (LS) is the most common hereditary colorectal cancer (CRC) predisposing condition and it is caused by germline mutations in the DNA mismatch repair (MMR) genes. Due to the high risk of multiple CRCs, the latest clinical guidelines recommend total or subtotal colectomy as standard CRC treatment in patients with LS under 60 years of age.

The objective of our work is the clinical characterization of a series of patients with LS and CRC, as well as the type of surgery performed and the possible association with second tumors.

Patients

A total of 194 families with LS identified through the Hereditary Cancer Program of the Catalan Institute of Oncology (Spain) between 1999 and 2015. We describe the clinical and molecular characteristics of carriers and patients with CRC, together with the surgical technique used in the treatment of the first CRC and its association with second tumors.

Results

From a total of 817 identified MMR mutation carriers, 380 were affected with CRC (mean age at diagnosis 47 years; 166 females / 214 males): single tumor in 279 patients and multiple in 101 (34 synchronous and 67 metachronous). The mean time to diagnosis of the second tumor was 10 years (range 1-40), without significant differences according to the mutated gene.

For 246 CRC-affected carriers (159 single and 87 multiple tumors; 28 synchronous / 59 metachronous), the type of surgery performed in the first CCR was known: 224 partial colectomies and 22 total /subtotal colectomies. Fifty-seven of 224 patients with partial surgery developed metachronous tumors (25.4%), compared to 2 of 22 patients with more extensive surgeries (9.1%). Overall survival tends to be higher in patients with total / subtotal surgery (20.9 vs. 8.55 mortality rate/1000/year)

Conclusion

Partial surgeries are associated with a greater number of metachronous CRCs, with a possible impact on the survival of these patients. These results should be confirmed in larger series.

PP91 - ENDOSCOPIC FOLLOW UP CAN SELECT PATIENTS FOR MULTI-GENE TESTING IN ATTENUATED ADENOMATOUS POLYPOSIS WITH NO APC OR MUTYH IDENTIFIED MUTATIONS.

M. Fornasari¹, R. Magris¹, M. Quai², S. Maiero¹, A. Viel², R. Cannizzaro¹

¹Oncological Gastroenterology Aviano, ²Funcional Onco-genomics and Genetics Aviano

Background: Less than a hundred polyps defines attenuated familial adenomatous polyposis (AFAP). APC or MUTYH involvement has been described in 60% of the cases. The natural history of AFAP without identified genetic defects is not enough evaluated. In our study we compare clinical and endoscopic features of polyposis in patients carrying APC or MUTYH mutation and wild type patients.

Methods: 102 cases (35 F, 67 M; mean age 51; range 28-79) of AFAPs were registered at our Institution between 1996 and 2014. They had no cancer family history and presented more than 10 adenomas at index colonoscopy. Genetic testing for APC and MUTYH genes was performed. Patients were put in a program, after having cleaned the colon, consisting in colonoscopy after one year and then the colonoscopic interval was based on the number of polyps from 1 to 3 years. Odds Ratio test was used to compare APC or MUTYH mutated and wild-type patients.

Results: Out of 102 patients with AFAP we identified a genetic defect in 36 patients (35,3 %; 12 with APC and 24 MUTYH) and 66 (64,7%) were wild-type. The mean endoscopic follow up was 10 years (2-31) in the mutated group and 9,7 years (2-23) in the wild-type group. Table 1 describes endoscopic and clinical features between the two groups. We observed some statistically differences between groups: the mutated group was younger than 50 years of age with a higher number of polyps, right colon was mainly involved and endoscopic follow-up was mostly every year. Patients of wild-type group never underwent to colectomy during follow-up and they displayed few adenoma recurrences in 24% of cases. On the other hand 14% of mutated patients underwent colectomy for dense polyposis and 28% had more polyps than at index colonoscopy and 11% no polyps at all. These 11% displayed mutation in MUTYH. Regarding extra-colonic manifestations we observed duodenal adenomas in 5 (13,8%) patients and desmoids tumor in one patient of mutated group. Two gastric cancers and one melanoma were diagnosed in the wild type group.

Conclusions: We observed a different behavior between mutated and wild-type patients. Patients with genetic involvement still developed adenomas during the follow-up and some needed colectomy. Instead, wild-type patients had mostly no recurrence. Constitutional genetic background could be suspected in wild-type patients when a continuous development of new polyps has observed and further genetic investigation should be offered by multi-gene testing.

	APC or MUTYH mutation = 36		Wild type = 66		Statistics
	Number	%	Number	%	
Gender					
male	19	52,78	48	72,73	OR 2.3860, 95% CI: 1.0203 to 5.5794 P = 0.0448
female	17	47,22	18	27,27	
Age at onset					
< 50	25	69,44	13	19,70	OR 9.2657 95 % CI: 3.6441 to 23.5597 P < 0.0001
≥ 50	11	30,56	53	80,30	
Number of polyps at index colonoscopy					
<20	17	47,22	47	71,21	OR 0.3617 95 % CI: 0.1555 to 0.8411 P = 0.0182
>20	19	52,78	19	28,79	
Polyps site					
right	29	80,56	18	27,27	OR 11.0476 95% CI: 4.1162 to 29.6510 P < 0.0001
left	7	19,44	48	72,73	
Synchron colorectal cancer					
yes	10	27,78	21	31,82	OR 0.8242 95% CI: 0.3369 to 2.0161 P = 0.6718
no	26	72,22	45	68,18	
Treatment polyposis					
colectomy	13	36,11	14	21,21	OR 2.0994 95% CI: 0.8532 to 5.1660 P = 0.1065
endoscopic polypectomy	23	63,89	52	78,79	
Colonoscopic interval					
1 year	19	52,78	0	0,00	OR 455.0000 95% CI: 23.3975 to 8848.1863 P = 0.0001
2-3 year	4	11,11	52	78,79	
Burden polyps in follow up					
no	4	11,11	36	54,55	OR 0.0936 95% CI: 0.0274 to 0.3197 P = 0.0002
less than at index colonoscopy	4	11,11	16	24,24	
more than at index colonoscopy and dense polyposis	15	41,67	0		
Tot	36	100,00	66	100,00	

Comparison of clinical and endoscopical feature between APC or MUTYH carriers versus wild type patients.

PP94 - EXOME SEQUENCING IDENTIFIED POTENTIAL CAUSATIVE CANDIDATE GENES FOR UNEXPLAINED COWDEN SYNDROME

F. Kratz¹, S. Peters¹, J. Kionke¹, S. Sivalingam¹, K. U. Ludwig², J. Henn¹, S. Holzapfel³, S. Aretz³, I. Spier³

¹Institute of Human Genetics, University of Bonn Bonn, Germany, ²Institute of Human Genetics, University of Bonn, Germany; Department of Genomics, Life & Brain Center, University of Bonn Bonn, Germany, ³Institute of Human Genetics, University of Bonn, Germany; Center for Hereditary Tumor Syndromes, University of Bonn Bonn, Germany

Purpose: Cowden syndrome (CS) is a cancer predisposition syndrome characterized by the occurrence of breast cancer, epithelial thyroid cancer, endometrial carcinoma and various other findings such as mucocutaneous lesions and macrocephaly. CS belongs to the PTEN hamartoma tumor syndrome (PHTS) primarily associated with germline mutations in *PTEN*. In recent years, germline mutations in additional genes (*SDHB*, *SDHC*, *SDHD*, *PIK3CA*, *AKT1*, *SEC23B*) have been described in few patients; however, to date, in 20-75% of patients meeting clinical criteria for CS the underlying cause remains unclear.

Methods: To uncover predisposing causative genes, the exomes of 11 clinically well characterized, unrelated patients with suspected, but unexplained CS were sequenced (Illumina HiSeq) using leukocyte DNA. Assuming a monogenic disease model, the called variants were filtered for rare (minor allele frequency $\leq 1\%$ for homozygous/compound heterozygous variants and $\leq 0.01\%$ for heterozygous variants according to dbSNP, EVS, and ExAC), truncating (nonsense, frameshift, highly conserved splice sites), and missense germline variants (predicted to be pathogenic by at least 2/3 in-silico tools). For data analysis and variant filtering the GATK software and the Cartagenia Bench Lab NGS Software were applied. All candidate genes were included in a Pathway Analysis (Ingenuity).

Results: After stringent filtering steps, comparison with large datasets from population-based controls, and detailed manual inspection to exclude artifacts, **75** genes harbor presumed biallelic variants (**16** homozygous and **59** putative compound-heterozygous), one of these is a known cancer gene (*CBFA2T3*). In **17** of these genes, biallelic variants were found in ≥ 2 patients. In addition, **23** genes were recurrently affected by heterozygous variants, but none of these are known cancer genes. In **132** genes, heterozygous truncating mutations occurred in only one patient, **4** of these are cancer genes (*MSH6*, *WRN*, *KDM5A*, *PML*). The pathway analysis of the candidate genes identified interacting partners of *PTEN* (*GRHL3*, *EHHADH*, *CSTF3*).

Conclusions: Preliminary data indicate that exome sequencing might identify potentially relevant causative genes for CS, some of which are recurrently mutated. The present work-up consists of the inclusion of further non-cancer genes, validation of variants by Sanger sequencing, testing of relatives to determine the phase of assumed biallelic variants and segregation with the phenotype where applicable.

PP95 - CLINICAL AND MOLECULAR CHARACTERIZATION OF LATIN AMERICAN PATIENTS SUSPECTED TO HAVE LYNCH SYNDROME

B. M. Rossi¹, E. I. Palmero², F. López-Kostner³, C. Sarroca⁴, C. Vaccaro⁵, F. Spirandelli⁶, P. Ashton-Prolla⁷, Y. Rodriguez⁸, H. de Campos Reis Galvão⁹, R. M. Reis¹⁰, A. Escremin de Paula², L. G. Capochin Romagnolo⁹, K. Alvarez³, A. Della Valle⁴, F. Neffa⁴, P. G. Kalfayan⁵, E. Spirandelli⁶, S. Chialina⁶, M. Gutiérrez Angulo¹¹, M. D. C. Castro-Mujica¹², J. Sanchez de Monte¹³, R. Quispe¹⁴, S. D. da Silva¹⁵, N. T. Rossi¹⁶, C. Barletta-Carrillo¹², S. Revollo¹⁴, X. Taborga¹⁴, L. Morillas¹⁷, H. Tubeuf¹⁸, E. M. Monteiro-Santos¹, T. A. Piñero¹⁹, C. Dominguez-Barrera²⁰, P. Wernhoff²¹, A. Martins²², E. Hovig²³, P. Måller²⁴, M. Dominguez-Valentin²³

¹Hospital Sirio Libanes, Sao Paulo, Brazil Sao Paulo, ²Molecular Oncology Research Center, Barretos Cancer Hospital, Brazil Barretos, ³Laboratorio de Oncología y Genética Molecular, Clínica Los Condes, Santiago, Chile Santiago, ⁴Hospital Fuerzas Armadas, Grupo Colaborativo Uruguayo. Investigación de Afecciones Oncológicas Hereditarias (GCU), Montevideo, Uruguay Montevideo, ⁵Hereditary Cancer Program (PROCANHE), Hospital Italiano, Buenos Aires, Argentina Buenos Aires, ⁶Servicio de Coloproctología y Asesoría Genética en Cáncer, Hospital Español de Rosario, Rosario, Argentina Rosario, ⁷Departamento de Genética da Universidade Federal do Rio Grande do Sul (UFRGS) e Serviço de Genética Médica do Hospital de Clínicas de Porto Alegre (HCPA) & Rede Brasileira de Câncer Hereditário Porto Alegre, ⁸Clinica del Country, Bogota, Colombia Bogota, ⁹Oncogenetics Department, Barretos Cancer Hospital, Brazil Barretos, ¹⁰Molecular Oncology Research Center, Barretos Cancer Hospital & Life and Health Sciences Research Institute (ICVS), Health Sciences School, University of Minho, Braga, Portugal AND ICVS/3B's-PT Government Associate Laboratory, Braga/Guimarães, Portugal Barretos, ¹¹Centro Universitario de los Altos, Universidad de Guadalajara, Jalisco, México Jalisco, ¹²Equipo Funcional de Genética y Biología Molecular, Instituto Nacional de Enfermedades Neoplásicas, Lima, Peru Lima, ¹³Instituto Nacional de Cancerología de México, México City, México Mexico City, ¹⁴Laboratorio de Genética Molecular del Instituto de Servicios de Laboratorio de Diagnóstico e Investigación en Salud (SELADIS), La Paz, Bolivia La Paz, ¹⁵Lady Davis Institute for Medical Research and Segal Cancer Center, Jewish General Hospital, Montreal, Quebec, Canada; Department of Otolaryngology-Head and Neck Surgery, McGill University, Montreal, Quebec, Canada Montreal, ¹⁶Hospital Privado Universitario de Córdoba, Córdoba, Argentina Córdoba, ¹⁷Centro de Enfermedades Neoplásicas ONCOVIDA, La Paz, Bolivia La Paz, ¹⁸Inserm-U1079-IRIB, UNIROUEN, Normandie Univ, Normandy Centre for Genomic and Personalized Medicine, Rouen, France Rouen, ¹⁹Instituto de Ciencias Básicas y Medicina Experimental (ICBME), Hospital Italiano, Buenos Aires, Argentina Buenos Aires, ²⁰Department of Preventive Medicine, Faculty of Medicine, Universidad Nacional Mayor de San Marcos (UNMSM), Lima, Peru Lima, ²¹Department of Clinical Molecular Biology (EpiGen), Akershus University Hospital, Lørenskog, Norway Oslo, ²²Department of Clinical Molecular Biology (EpiGen), Akershus University Hospital, Lørenskog, Norway Rouen, ²³Department of Tumor Biology, Institute for Cancer Research, Oslo University Hospital, Oslo, Norway Oslo, ²⁴Department of Medical Genetics, Oslo University Hospital, Norway Oslo

Background. Genetic counselling and testing for Lynch syndrome (LS) have recently been introduced in several Latin American countries.

Aim. To characterize the clinical, molecular and mismatch repair (MMR) variants spectrum of suspected LS families from Latin America.

Methods. Eleven LS hereditary cancer registries and 34 published LS databases were used to identify unrelated families that fulfilled the Amsterdam II (AMSII) criteria and/or the Bethesda guidelines or suggestive of a dominant CRC inheritance syndrome.

Results. We performed a thorough investigation of 15 countries and identified 6 countries where germline genetic testing for LS is available and 3 countries where tumor testing is used in the LS diagnosis. The spectrum of pathogenic MMR variants spectrum included *MLH1* up to 54%, *MSH2* up to 43%, *MSH6* up to 10%, *PMS2* up to 3% and *EPCAM* up to 0.8%. The Latin American spectrum is broad with a total of 220 different variants which 80% were private and 20% were recurrent. Frequent regions included exons 11 of *MLH1* (15%), exon 3 and 7 of *MSH2* (17 and 15%, respectively), exon 4 of *MSH6* (65%), exons 11 and 13 of *PMS2* (31% and 23%, respectively). Sixteen international founder variants in *MLH1*, *MSH2* and *MSH6* were identified and 41 (19%) variants have not previously been reported, thus representing novel genetic variants in the MMR genes. The AMSII criteria was the most used criteria to identify pathogenic MMR carriers although microsatellite instability, immunohistochemistry and family history are still the primary methods in several countries where no genetic testing for LS is available yet.

Conclusion. The Latin American LS pathogenic MMR variants spectrum included new variants, frequently altered genetic regions and potential founder effects, emphasizing the relevance implementing Lynch syndrome genetic testing and counseling in all of Latin American countries.

The authors declare that they have no competing interests

PP96 - IDENTIFICATION OF GENETIC BIOMARKERS FOR CLINICAL MANAGEMENT OF FAMILIAL COLORECTAL TUMORS

M. Dominguez-Valentin¹, S. Nakken¹, H. Tubeuf², D. Vodak¹, P. O. Ekström¹, A. M. Nissen³, M. Morak³, E. Holinski-Feder³, A. Martins², P. Mähler⁴, E. Hovig¹

¹Department of Tumor Biology, Institute for Cancer Research, Oslo University Hospital, Oslo, Norway Oslo, ²Inserm-U1245, UNIROUEN, Normandie Univ, Normandy Centre for Genomic and Personalized Medicine, Rouen, France Rouen, ³Medizinische Klinik und Poliklinik IV, Campus Innenstadt, Klinikum der Universität München, Ziemssenstr. 1, Munich, Germany Munich, ⁴Department of Medical Genetics, Oslo University Hospital, Norway Oslo

Aim: To identify new inherited genetic variants that influence biological and clinical characteristics of colorectal cancer (CRC) developed in high-risk patients.

Method: The hereditary cancer biobank from the Norwegian Radium Hospital was interrogated to identify non-related high-risk CRC individuals for whom no disease-predisposing mutations in mismatch repair (MMR) genes had been found by diagnostic DNA sequencing. Forty-four familial breast or CRC cancer risk-related genes were selected and analyzed by our in-house designed TruSeq amplicon-based assay for targeted resequencing (TSCA v.1.5, Illumina). Then, protein and splicing-dedicated *in silico* analyses were performed for all unclassified single-nucleotide variants (SNVs) in order to predict their biological impact. A special emphasis was given to variants with a potential negative effect on splicing. Next, selected SNVs were experimentally analyzed by comparing the splicing pattern of representative reporter minigene constructs transfected into human cells.

Results: In total, we identified 38 individuals fulfilling the Amsterdam II and/or the Bethesda criteria. In one of these patients (1/38, i.e. 3%) we detected a *CHEK2* Class 5 variant (c.470T>C; p.I157T). In addition, twenty-five unique Class 3 SNVs were identified in 19 individuals, of which 2 SNVs (1 in *NOTCH3* and 1 in *MAP3K1*) were analyzed in the minigene splicing assay and found not to induce splicing defects in this system

Conclusion: Among high-risk patients testing negative for MMR mutations, multiple-gene sequencing identified a pathogenic variant in a moderate-penetrance gene not traditionally associated with CRC (*CHEK2*) and minigene assays suggest that splicing alterations may not be the major inactivation mechanism for the 2 analyzed SNVs, which remain of unknown significance. Our study indicates that the analysis of genes currently excluded from routine molecular diagnostic screens may be important for assessing CRC predisposition.

PP97 - ASSESSING HOW REDUCED EXPRESSION LEVELS OF THE MISMATCH REPAIR GENE PMS2 AFFECT REPAIR EFFICIENCY

M. Kasela¹, M. Kansikas², L. Vähäkallio², M. Nyström¹

¹Department of Biosciences Helsinki, ²LS CancerDiag Ltd Helsinki

Objective: Lynch syndrome (LS) is associated with DNA mismatch repair (MMR) malfunction. While decreases in expression of the main LS susceptibility genes *MLH1*, *MSH2* and *MSH6* have been shown to affect the MMR capability, the influence of reduced *PMS2* expression is not yet known. In this study, the repair efficiency of knockdown (KD) cell lines retaining varying levels of *PMS2* mRNA expression is assessed in a functional *in vitro* MMR assay.

Methods: Four different *PMS2*-specific shRNA targets were used for stable transfection in human fibroblasts. A control cell line was transfected with a shRNA vector with no known target specificity in the human genome. Transfected cells were selected with hygromycin B and at least two rounds of clonal isolation was conducted to ensure a homogenous cell population. Total RNA was reverse transcribed into cDNA and quantitative PCR (Q-PCR) carried out using Taqman® assays for *PMS2* (Hs00241053_m1) and *GAPDH* (Hs02758991_g1), *HPRT1* (Hs02800695_m1) and *ACTB* (Hs01060665_g1) as reference genes. Nuclear protein extracts were quantified and the repair efficiency of the selected KD cell lines and the control was measured in the *in vitro* MMR assay.

Results: Altogether three KD clones retaining 18.5%, 33% and 52.5% of *PMS2* expression were selected for functional analysis. A prerequisite for clone selection was that the KD cell line would retain 50% of *PMS2* expression (mutation carrier level) or less. Two clones have been tested in the MMR assay and both showed repair capability although they repaired less efficiently than their respective controls. Further tests are ongoing.

Conclusions: Pathogenic *PMS2* mutations have been difficult to detect and interpret due to several *PMS2* pseudogenes in the human genome, their low penetrance and complex disease phenotype with variable clinical characteristics. Our preliminary findings suggest that the reduced level of *PMS2* mRNA expression results in lowered MMR efficiency and that the *in vitro* MMR assay could thus be used to recognize *PMS2* expression levels indicative of Lynch syndrome.

PP99 - CLINICOPATHOLOGICAL FEATURES OF APC MUTATION-NEGATIVE FAP PATIENTS

H. Ishida¹, T. Yamaguchi¹, M. Takao¹, H. Eguchi², Y. Okazaki², H. Ishida³

¹Department of Surgery, Tokyo Metropolitan Cancer and Infectious Diseases Center Komagome Hospital Tokyo, ²Division of Translation Research, Research Center for Genomic Medicine, Saitama Medical University Hidaka, ³Department of Digestive Tract and General Surgery, Saitama Medical Center, Saitama Medical University Kawagoe

Background and aims: Approximately one third of patients of familial adenomatous polyposis (FAP) were reported not to show *APC* mutation. The reason why we cannot detect *APC* mutation in such patients remains to be seen and the clinical features of *APC* mutation-negative FAP have not been fully understood. The aim of this study was to clarify the clinicopathological features of *APC* mutation-negative FAP patients.

Patients and Methods: After obtaining informed consents, Sanger method and MLPA method were used to analyze mutation of *APC* in the individuals who were clinically suspicions of FAP. If no mutation was found in *APC* gene, genetic testing was performed by Mi-Seq (Illumina) using HaloPlex technologies. The genes we captured were the followings; *APC*, *MUTYH*, *POLE*, *POLD1*, *SKT11*, *SMAD4*, *BMPRIA*, *PTEN*, *MLH1*, *MSH2*, *MSH6*, *PMS2*, *EPCAM*, *MBD4*, *TGFBR2*, *MLH3*, *MSH3*, *PMS1*, *TP53*, *CDH1*, *AKT1*, *PIK3CA*, *SDHD*, *ENG*, and *RPS20*. Detected variants were also confirmed by Sanger and MLPA methods.

Result: Of 20 individuals included in this study, 13 (65%) showed *APC* mutation, and 7 (35%) were not detected germline mutation in 26 genes, including *APC* gene. Male ratio and mean age in *APC* mutant FAP and *APC* mutation-negative FAP were 31% vs. 57%, and 40.6 (range 18–59) vs. 56.0 (range 28–79), respectively. Of 13 *APC* mutant individuals, 10 (77%) were classical FAP and 3 (23%) were attenuated FAP (AFAP). Of 7 *APC* mutation-negative individuals, 4 (57%) were classical FAP and 3 (43%) were AFAP. Duodenal lesions and fundic gland polyposis (FGP) in *APC* mutant FAP and *APC* mutation-negative FAP were found in 7/13 (54%) vs. 2/7 (29%) and 5/13 (38%) vs. 3/7 (43%). Extracolonic tumors in *APC* mutant FAP and *APC* mutation-negative FAP were found in 5 (duodenal carcinoma in 2, desmoid tumor in 2, and thyroid carcinoma in 1) and 2 (duodenal carcinoma in 1 and renal carcinoma in 1), respectively.

Conclusion: Although the number of this study was too small to conclude, our result suggested that compared with *APC* mutant FAP, *APC* mutation-negative FAP were diagnosed at older age and they had fewer polyps, and they were less likely to have duodenal lesion. Considering that previous reports have shown that there is genotype-phenotype correlation in FAP, there can be unknown gene in *APC* mutation-negative FAP.

PP101 - GERMLINE MUTATIONS IN MICRORNAS IN HEREDITARY COLORECTAL CANCER

P. Mur¹, A. Closa², N. Seguí¹, E. Fuentes-Mattei³, C. Zapater¹, X. Solà², G. Aiza¹, M. Navarro¹, J. Brunet⁴, C. Lázaro¹, V. Moreno², G. A. Calin³, G. Capellà¹, L. Valle¹

¹Hereditary Cancer Program, Catalan Institute of Oncology, IDIBELL and CIBERONC, Barcelona, Spain, ²Unit of Biomarkers and Susceptibility, Catalan Institute of Oncology, IDIBELL and CIBERESP, Barcelona, Spain, ³Department of Experimental Therapeutics, The University of Texas MD Anderson Cancer Center, Houston, TX, US, ⁴Hereditary Cancer Program, Catalan Institute of Oncology, IDIBGi, Girona, Spain

Background and aim. Part of the genetic predisposition to colorectal cancer (CRC) remains unexplained, suggesting yet-to-be-discovered genetic alterations that escape current strategies focused on variants affecting coding regions. Here we studied the relevance of germline mutations in microRNAs in suspected hereditary CRC predisposition.

Patients and methods. Small RNA-seq was performed in: 1) blood RNA from 22 hereditary CRC cases without mutations in known high-penetrance genes to identify germline mutations in mature microRNAs, and 2) in 50 normal colon mucosae from healthy individuals (M) and 100 normal tissue adjacent to tumor from CRC patients (N), to identify microRNAs deregulated at early stages of colorectal carcinogenesis. Sanger sequencing was used for germline mutation screening of all M/N deregulated microRNAs in 43 hereditary CRC cases, and for confirmation in blood DNA of the RNA variants identified by small RNA-seq. The identified variants that cosegregated with cancer in the carrier families were genotyped in 288 sporadic CRC patients, 288 controls and 475 familial CRC cases.

Results. No germline novel or rare variants in mature microRNAs were identified. Six novel or rare germline variants were identified in 5 of the 51 microRNAs deregulated early in colorectal carcinogenesis. Only hsa-miR-99a n.152delG was not present at high frequency in controls and segregated with CRC in the family, which also carried a disruptive mutation in a gene recently suspected to be associated with hereditary CRC. No additional n.152delG carriers were identified among 475 CRC families. However, when hsa-miR-99a was completely sequenced in these cases we identified 2 additional rare variants (MAF<1%): miR99a n.226G>T, identified in an adopted patient, and n.77G>C, which did not segregate with CRC in the family. MiR99a was significantly down-regulated in CRC tissues compared with the corresponding adjacent normal tissue indicating that it might have a relevant role in colorectal cancer.

Conclusions. Although preliminary, our results suggest that the contribution of high-impact germline microRNA mutations to hereditary CRC is very rare, analysis of larger patient cohorts is needed to definitively discard or confirm the role of hsa-miR-99a in CRC predisposition. Functional studies to determine the pathogenic nature of the identified variants and the role of hsa-miR-99a in colorectal carcinogenesis will be presented.

PP103 - IDENTIFICATION OF A NEW POLE GERMLINE VARIANT WHEN EVALUATING THE DIAGNOSTIC UTILITY OF POLE AND POLD1 HOTSPOTS SCREENING IN A 600 POLYPOSIS PATIENT COHORT

D. Rueda¹, S. Tapia¹, D. Parraga², M. Gallego¹, N. Carrizo¹, I. Rey², M. Pineda³, D. Marrupe⁴, J. Mesa⁵, L. Robles⁶, J. Diaz-Tasende⁷, I. Salces⁷, J. Perea⁸, M. de Migue¹, J. C. Marin⁷

¹Hereditary Cancer Genetics Laboratory, Biochemistry Dept., 12 de Octubre University Hospital. Colorectal Cancer Research Group. i+12 Research Institute. Madrid (Spain), ²Hereditary Cancer Genetics Laboratory, Biochemistry Dept., 12 de Octubre University Hospital. Madrid (Spain), ³Catalan Institute of Oncology, ICO-IDIBELL Barcelona (Spain), ⁴Oncology Dept., Hospital de Mostoles Mostoles (Madrid), ⁵Principe de Asturias Hospital Alcala de Henares (Spain), ⁶Oncology Dept., 12 de Octubre Hospital Madrid (Spain), ⁷Gastroenterology Dept. 12 de Octubre University Hospital Madrid (Spain), ⁸Colorectal Cancer Research Group. i+12 Research Institute. Madrid (Spain)

Hereditary adenomatous polyposis encompass a heterogeneous group of disorders characterized by predisposition to multiple colorectal adenomas and a higher susceptibility to cancer. Depending on the germline mutated gene, the patient will develop different phenotypes, thus different clinical follow-ups will be adopted. Upon adenomatous polyposis clinical diagnosis mutation screening is recommended, classically mutations in APC gene (Familial adenomatous polyposis, FAP, autosomal dominant, OMIN #175100) and/or MUTYH (MUTYH-associated polyposis, MAP, autosomal recessive, OMIM #608456). Recently more genes have been related to adenomatous polyposis phenotypes: POLE and POLD1 (Polymerase Proofreading-Associated Polyposis, PPAP, autosomal dominant, OMIN # 615083), NTHL1 gene (autosomal recessive, OMIN #616415) and MSH3 gene (autosomal recessive, OMIN #617100).

Since 2009, Hereditary Cancer Genetics Laboratory from 12 de Octubre University Hospital has studied polyposis germline samples, following a routine screening set up focussed on MUTYH hotspots and/or APC / MUTYH whole-gene study depending on number of polyps, age of onset and inheritance. Germline pathogenic mutations were detected on 14.2% studied polyposis patients, being 38,8% APC mutated, 35,2% biallelic MUTYH and 26,0% monoallelic MUTYH carriers.

To evaluate whether it was worth to incorporate POLE and POLD1 in our polyposis hotspot screening setup, we tested using high resolution melting analysis the frequency of the reported as most frequent mutations POLE c.1270C>G, p.(Leu424Val), and POLD1 c.1433G>A, p.(Ser478Asn), on 600 polyposis samples previously tested negative for MUTYH hotspots, many of them also tested negative for whole gene APC and MUTYH.

None of the frequent mutations were detected in our cohort, neither other previously described mutations. However, POLE c.1274A>G, p.Lys425Arg, variant was detected on two independent polyposis patients. The carriers were diagnosed with attenuated adenomatous polyposis, belonging to two different families with aggregation of polyps. p.Lys425Arg shares POLE exonuclease domain localization and various bioinformatic predictor scores with p.Leu424Val. Ongoing variant-phenotype cosegregation studies in these two families should help us to clarify the role of POLE p.Lys425Arg in Polymerase Proofreading-Associated Polyposis.

Our results suggest that direct POLE or POLD1 hotspots screening has a poor yield, then it is not justified to incorporate it to a clinical setup. However, these genes, as well as many others should be incorporated into broad gene panel testing for hereditary adenomatous polyposis or hereditary colorectal cancer.

Funding: This work was funded by Project PI13/0127 and PI16/01650 from the Spanish Ministry of Health and Consumer Affairs and FEDER.

PP104 - A NOVEL TOOL FOR QUANTITATIVE ANALYSIS OF MICROSATELLITE MUTATIONS

A. Ballhausen¹, S. Krausert¹, J. Janikovits¹, A. Ahadova¹, E. Pfaffendorf¹, M. von Knebel Doeberitz¹, M. Kloor¹

¹Department of Applied Tumor Biology, Institute of Pathology, University Hospital Heidelberg Heidelberg

Background:

Cancer genome sequencing has gained increasing relevance in diagnostics and therapeutic decision making in oncology. However, the sensitive and specific detection of insertion/deletion mutations in microsatellite regions still remains a major technical challenge due to the occurrence of “stutter bands”. Therefore, traditional fragment analysis remains the gold standard for coding microsatellite (cMS) mutation detection, although only used as a qualitative method unable to estimate allele frequencies. We aimed at the development of a tool that allows removal of stutter bands and thereby a precise quantitative determination of cMS allele distributions.

Materials and Methods:

We have developed a tool to discriminate “true” allele-specific peaks from artifacts resulting from stutter band overlay. This method was first tested and optimized on data obtained from fragment length profiles, which were generated by PCR with fluorescently labeled oligonucleotide primers and visualized on an ABI3130xl sequencer. We then evaluated sensitivity and specificity using DNA samples from cell lines with known mutational profiles mixed at defined ratios in a step-wise manner. Finally, a preliminary analysis of clinical microsatellite-unstable cancer specimens was performed.

Results:

The novel matrix was highly effective in reproducibly transforming raw peak profiles into clear allele patterns. Cell culture DNA mixture experiments showed that our method can discriminate allele frequencies with a resolution of up to 5%. In a preliminary analysis of clinical tumor tissue specimens, we could demonstrate that the new algorithm enhanced the sensitivity of cMS mutation detection (e.g. 85% ACVR2 A8 mutations compared to 68% using conventional methods). Importantly, it powerfully discriminated cMS with a high frequency of biallelic mutations, e.g. TGFBR2 with 19 (50%) out of 38 or ASTE1 with 14 (42%) out of 33 cancers, from those with rare biallelic inactivation, e.g. TCF7L2 with 2 (5%) out of 40 cancers.

Conclusion:

We present a new objective tool for quantitative calling of cMS mutations. Our results show that the new algorithm is a powerful tool to identify driver genes in microsatellite-unstable cancer. The systematic analysis of a large set of cMS, currently under way, will deepen our knowledge on the role of cMS driver mutations in the pathogenesis of microsatellite-unstable cancers. This algorithm may also provide the basis for new approaches to quantify microsatellite instability by next generation sequencing.

PP106 - NEXT GENERATION SEQUENCING INCREASES THE SENSITIVITY IN FAMILIAL ADENOMATOUS POLYPOSIS AND MUTYH-ASSOCIATED POLYPOSIS TESTING: A LABORATORY AND CLINICAL PERSPECTIVE

E. Alexander¹, S. Bunstone², E. Howard², T. Clancy¹

¹Clinical Genetics Service, Manchester Centre for Genomic Medicine Manchester, ²Genomic Diagnostics Laboratory, Manchester Centre for Genomic Medicine Manchester

Here we demonstrate the advantage of using a more sensitive screening method to provide a molecular diagnosis for patients previously given a negative genetic result and the clinical impact this had for the patients and their families.

Previous Sanger sequencing analysis of APC in 4 patients clinically diagnosed with a polyposis condition did not detect a mutation. Following the introduction of a new combined APC/MUTYH NGS and MLPA screen at the Genomic Diagnostics Laboratory in Manchester, germline DNA from these 4 patients was re-analysed and a pathogenic mutation was found in each sample. A mosaic nonsense APC mutation was identified in 2 patients at a level of 12% and 14% of reads respectively. One patient, previously thought to have FAP, was diagnosed with MAP following the detection of a homozygous pathogenic missense MUTYH mutation. The fourth patient was found to have an APC promoter deletion detected by the MLPA.

These results have needed to be communicated to the patients and families and have allowed for accurate genetic counselling. In the 4 cases presented here the results have excluded 3 children from risk and 8 first degree relatives now have the option of a predictive genetic test to confirm their risk of the familial condition and inform screening decisions.

PP110 - LYNCH SYNDROME FAMILY WITH CO-OCCURRENCE OF GERMLINE PATHOGENIC SPLICE SITE MUTATIONS OF MSH2 AND MSH6

I. Vogelaar¹, Y. Hu¹, F. Wang¹, S. Haraldsdottir¹, B. Fairbank², R. Rapkins³, J. Balcom⁴, A. Leininger⁵, M. Hitchins¹

¹Department of Medicine (Oncology), Stanford Cancer Institute, Stanford University Stanford, CA, USA, ²Lynch Syndrome Australia The Summit, QLD, Australia, ³Lowy Cancer Research Centre, University of New South Wales Sydney, Australia, ⁴Department of Laboratory Medicine and Pathology, Mayo Clinic Rochester, MN, USA, ⁵Minnesota Oncology Woodbury, MN, USA

Lynch syndrome (LS) is caused by an autosomal dominant heterozygous germline (epi-)mutation of one of the DNA mismatch repair (MMR) genes (*MLH1*, *MSH2*, *MSH6* or *PMS2*). Disease penetrance, tumor spectrum and mean age of onset vary depending on the gene mutated. Genetic counseling and surveillance recommendations are based on the gene affected.

We describe the first family with co-occurrence of two pathogenic germline MMR mutations; a multibranch cancer-affected family carrying the *MSH2* mutation c.2006G>T, in which one branch additionally carries a novel *MSH6* mutation c.3936_4001+8dup. *MSH2* and *MSH6* are neighboring genes located on chr2p21. Pedigree analysis showed the two mutations segregated independently, indicating they are located on separate chr2p21 alleles; some family members carried both mutations, others carried one or the other, whilst others were negative for both. Functionally, RNA analyses showed both are splice mutations that result in out-of-frame exon skipping, ultimately resulting in protein truncation. The *MSH2* mutation leads to skipping of exon 13 and the *MSH6* mutation results in skipping of exon 9.

The identification of two pathogenic mutations in one family has serious implications in terms of cancer risk stratification and genetic counselling, as cancer risks differ between members of the same nuclear family according which variant, and the number of variants, individuals carry. Carriers of *MSH2* c.2006G>T would have higher risks of colorectal cancer than carriers of *MSH6* c.3936_4001+8dup, with recommendations to begin surveillance colonoscopy about 10 years earlier. However, the risk for endometrial cancer in female carriers would be similar for both mutations. Whether carriers of both mutations may be at even higher risks for cancer could not be estimated due to the small number of carriers of both variants. In addition, for carriers of a single variant, the risk of transmission to offspring is 50%, as per classic Lynch syndrome. However, given that the mutations are on separate chr2p21 homologues, carriers of both variants have a 100% risk of transmission of one or other variant.

This family illustrates the need for caution when limiting genetic screening to site-specific mutation testing in families with LS (and other high-risk cancer syndromes). The possibility of a second cancer-predisposing mutation should be considered when the known familial mutation is not found in cancer-affected family members.

PP111 - THE OPTIMAL DOSE AND DURATION OF DAILY ASPIRIN AS A CANCER PREVENTIVE IN LYNCH SYNDROME

J. Burn¹, H. Sheth¹, F. Elliott², F. Macrae³, J. Mecklin⁴, G. Moeslein⁵, D. Eccles⁶, D. G. Evans⁷, E. R. Maher⁸, L. Bertario⁹, M. Bisgaard¹⁰, M. Dunlop¹¹, A. Gerdes¹², J. W. C. Ho¹³, S. V. Hodgson¹⁴, A. Lindblom¹⁵, J. Lubinski¹⁶, P. J. Morrison¹⁷, V. Murday¹⁸, R. Ramesar¹⁹, L. Side²⁰, R. J. Scott²¹, H. J. W. Thomas²², H. F. Vasen²³, G. Borthwick¹, K. Pylvanainen²⁴, H. T. Lynch²⁵, J. C. Mathers²⁶, D. T. Bishop²

¹Institute of Genetic Medicine, Newcastle University Newcastle upon Tyne, UK, ²Leeds Institute of Molecular Medicine, Leeds University Leeds, UK, ³Royal Melbourne Hospital Melbourne, Australia, ⁴Dept of Surgery, Jyväskylä Central Hospital Jyväskylä, Finland, ⁵HELIOS Universitätsklinikum Wuppertal Wuppertal, Germany, ⁶Clinical Genetics Unit, Southampton General Hospital Southampton, UK, ⁷Dept of Medical genetics, St Mary's Hospital Manchester, UK, ⁸Dept of Medical genetics, Cambridge University Cambridge, UK, ⁹Inst. Nazionale per lo Studio e la Cura dei Tumori Milan, Italy, ¹⁰University of Copenhagen Copenhagen, Denmark, ¹¹MRC Human Genetics Unit, Western General Hospital Edinburgh, UK, ¹²Klinisk Genetisk Klinik, Rigshospitalet Copenhagen, ¹³Dept of Surgery, Queen Mary Hospital Hong Kong, China, ¹⁴St George's Hospital London, UK, ¹⁵Dept Molecular Medicine and Surgery, Karolinska Hospital Stockholm, Sweden, ¹⁶International Hereditary Cancer Institutet Szczecin, Poland, ¹⁷Dept of Medical Genetics, Queens University Belfast, UK, ¹⁸Medical Genetics, Yorkhill Glasgow, UK, ¹⁹Division of Human Genetics, University of Cape Town Cape Town, South Africa, ²⁰Dept of Clinical Genetics, Churchill Hospital Oxford, UK, ²¹Hunter Area Pathology Service New Lambton, NSW, Australia, ²²St Marks Hospital, Imperial College London, UK, ²³Leiden University Medical Centre Leiden, Netherlands, ²⁴Jyväskylä Central Hospital Jyväskylä, Finland, ²⁵Hereditary Cancer Institute, Creighton University Medical Centre Omaha, Nebraska, USA, ²⁶Human Nutrition Research Centre, Newcastle University Newcastle upon Tyne, UK

~Between 1998 and 2006, 861 Lynch syndrome gene carriers were recruited to the 600mg aspirin (427) versus aspirin placebo(434) limb of the double blind randomised factorial chemoprevention trial CAPP2. In 2011 a greater than 50% reduction in colorectal and other Lynch syndrome cancers was reported. In 2016 the last of the recruits reached the planned 10 year follow up. Aspirin intervention had ceased after a mean of 2.5 years (upper limit 4 years). Over 99% remained blinded until at least 10 years. A total of 130 Lynch cancers have been recorded, 109 within the 10 year threshold. Of the latter group, 47 were in the aspirin group and 62 in the placebo group. Cumulative analysis supports the hypothesis that there was a period of true cancer prevention rather than delayed appearance of malignancy. A more accurate time to onset of cancer prevention and duration of effect will be presented. There is continued evidence of a relationship between cumulative dose and outcome, supporting the case for the dose non-inferiority randomised trial (CaPP3) comparing 600mg daily with 300mg or 100mg over 5 years. After First Recruit First Visit in 2014, to date half of the 2000 subjects needed have been recruited.

PP112 - IDENTIFICATION OF TYPE AND FREQUENCY OF TUMORS IN CHILEAN FAMILIES WITH LYNCH SYNDROME

K. ALVAREZ¹, E. PINTO², C. HEINE², B. SOLAR³, C. HURTADO¹, U. KRONBERG², F. LÄ"PEZ-KÄ-STNER²

¹LABORATORIO DE ONCOLOGÍA Y GENÉTICA MOLECULAR, CLÍNICA LAS CONDES SANTIAGO-CHILE, ²UNIDAD DE COLOPROCTOLOGÍA, CLÍNICA LAS CONDES SANTIAGO-CHILE, ³SECCIÓN GENÉTICA, HOSPITAL CLÍNICO UNIVERSIDAD DE CHILE SANTIAGO-CHILE

Introduction: Lynch syndrome is an autosomal dominant disease caused by germline mutations in mismatch repair genes (MLH1, MSH2, MSH6 and PMS2) or EPCAM gene deletions, which predispose to colorectal cancer with a penetrance up to 80% and other tumors in different organs with a variable penetrance (2-60%).

Aim: To identify the type and frequency of neoplasms in Chilean families with Lynch syndrome.

Methods: From our hereditary colorectal cancer registry at Clinica Las Condes, we selected Chilean families with Lynch syndrome and known germline mutation. Clinical information of each family was obtained through clinical records and patient interviews.

Results: In total, 30 Lynch syndrome families with known germline mutation were selected. The vast majority of families 26/30 (87%) meet Amsterdam criteria, and only four complete Bethesda criteria (13%). Most families carry mutations in *MLH1* (63%) and *MSH2* (23%), and the remainder in *PMS2* (7%) and *EPCAM* (7%). In the genealogies, we identified 763 individuals, with an average of 25 members per family. Of these, 193 (25%) individuals have been diagnosed with cancer (91 men and 102 women), who have developed 262 different tumors. Specifically, we identify 117 tumors in men and 145 tumors in women. Colorectal cancer was more common in men than in women (74% versus 43%), while extracolonic tumors were more frequent in women (57% versus 26%) ($p < 0.0001$). In total, eighteen different neoplasms were identified. The second most common tumor in men was gastric cancer (9%), and in women was uterine (22%) and breast (9%) cancer. The mean age at tumor diagnosis varies between 20-67 y.o., being brain cancer the earliest detected neoplasm, with a mean age of 20 years (range 10-36). Ovary, colorectal, uterine, pancreatic and stomach cancer showed a mean age of 44, 45, 50, 52 and 54 years, respectively. Breast, kidney/bladder, prostate and skin cancer were diagnosed at average age 63, 66, 67 and 67 years, respectively. Mutations in *MLH1* predispose more to colorectal cancer than to extracolonic tumors (62% versus 38%), compared to *MSH2* (49% versus 51%) and *PMS2* (33% versus 67%) ($p = 0.0624$). Families with mutated *MSH2* developed more uterine, ovary, kidney and brain cancer, and families with mutated *MLH1* demonstrated a high frequency of colorectal cancer, skin, and prostate cancer.

Conclusion: This study confirms the high frequency and wide spectrum of tumors in Chilean families with Lynch syndrome, which vary depending on the underlying mutation.

PP113 - EXPERIENCE OF AN E-LEARNING COURSE ABOUT GENETIC COUNSELING IN HEREDITARY CANCER FOR LATIN AMERICA HEALTH PROFESSIONALS

F. LPEZ-KSTNER¹, K. ALVAREZ², S. MARGARIT³, M. ALVARADO⁴, C. RICKER⁵, M. E. BRAVO⁶, P. CARVALLO⁷, C. HURTADO², E. PINTO¹, M. J. MULLINS⁸, U. KRONBERG¹

¹UNIDAD DE COLOPROCTOLOGA, CLNICA LAS CONDES SANTIAGO-CHILE, ²LABORATORIO DE ONCOLOGA Y GENTICA MOLECULAR, CLNICA LAS CONDES SANTIAGO-CHILE, ³CLNICA ALEMANA SANTIAGO-CHILE, ⁴KAISER PERMANENTE MEDICAL CENTER LOS ANGELES-EEUU, ⁵MEDICAL ONCOLOGY, CANCER GENETICS LOS ANGELES-EEUU, ⁶CENTRO CLINICO DEL CANCER, CLINICA LAS CONDES SANTIAGO-CHILE, ⁷LABORATORIO DE GENETICA MOLECULAR HUMANA, P. UNIVERSIDAD CATLICA DE CHILE SANTIAGO-CHILE, ⁸SANTIAGO SANTIAGO-CHILE

Introduction: A specialized healthcare team (HT) of professionals with knowledge and experience in the clinical management of inherited cancer predisposition is necessary to provide optimal care to high-risk families. In many countries, genetic counselors are key members of the cancer genetics HT. In Latin America, there are very few genetic counselors due to the lack of training programs. In 2013, a multidisciplinary group of professionals with expertise in hereditary cancer syndromes developed an e-learning course about genetic counseling in hereditary cancer for health professionals in all Latin America. The goal was to provide specialized training to oncology professionals, and improve the care of high-risk patients in this region of the world.

Aim: To evaluate the clinical practice utility of an e-learning course about genetic counseling in hereditary cancer.

Methods: One year after graduation, students were contacted via email to answer a survey consisting of the seven questions: Are you working in a high-risk oncologic group? Were you able to implement hereditary cancer registries? Are you working in a multidisciplinary team? Were you able to increase referral to genetic studies? Did you communicate your experience in national congresses? Did you participate in any related international congresses? Were you able to design clinical or research projects?

Results: To date, 39 students have completed the course, whose majority corresponds to physicians (27), followed by nurses (8) and MSc-PhD (4). Students are coming from Chile (27), Colombia (7), Argentina (2), Peru (2) and Dominican Republic (1). In total, 26/39 (67%) students completed the survey. Of these, 58% are part of a high-risk oncology group, 65% are working in a hereditary cancer registries, 69% are supported by a multidisciplinary team, 81% are referring patients to genetic studies, 42% and 50% have attended or are planning to attend at one national or international congress/conference respectively, and 62% are planning or developing at least one clinical or research project.

Conclusion: Students who completed this e-learning course in cancer genetic counseling are already applying their knowledge in order to improve the care of high-risk patients and families in Latin America. They have started high-risk tumors groups, are developing hereditary cancer registries, clinical and research projects and participating in continuous education.

PP114 - ATTITUDE AND KNOWLEDGE TOWARDS GENETIC COUNSELING AND TESTING FOR THE MAIN COLORECTAL CANCER PREDISPOSITION SYNDROMES: A SURVEY AMONG PRIVATE PHYSICIANS IN SWITZERLAND

V. Viassolo¹, A. Ayme², V. Chappuis¹, J. Theler³, I. Guessous⁴, P. Chappuis⁵

¹Unit of Oncogenetics and Cancer Prevention, Division of Oncology, Geneva University Hospitals Geneva, ²Division of Clinical Pathology, Geneva University Hospitals Geneva, ³Unit of Population Epidemiology, Division of Primary Care Medicine, Geneva University Hospitals Geneva, ⁴Unit of Population Epidemiology, Division of Primary Care Medicine, Geneva University Hospitals; Department of Ambulatory Care and Community Medicine, University of Lausanne, Lausanne Geneva, ⁵Unit of Oncogenetics and Cancer Prevention, Division of Oncology, Geneva University Hospitals; Division of Genetic Medicine, Geneva University Hospitals Geneva

Objectives: Despite a tremendous expansion of genetic information and testing options in predictive oncology, little is known about the capacity of non-geneticist physicians to correctly recognize and manage hereditary cancer cases. As most of the individuals concerned with colorectal cancer (CRC) risk are managed in the private sector of care in Switzerland, we explored the attitude of private practitioners towards genetic counseling and evaluated their knowledge about Lynch syndrome (LS) and familial adenomatous polyposis (FAP).

Methods: Between Nov. 2014 and Jan. 2015, a survey including several case scenarios has been mailed to all primary care physicians/internists (n=316), medical oncologists (n=17), general surgeons (n=56) and gastroenterologists (n=32) working in Geneva and Valais cantons, Switzerland.

Results: The overall response rate was 27.6% (116/421); no statistically significant difference was observed among different specialities. A minority of responders declared to be familiar with cancer risk in LS (37.1%), Bethesda guidelines (15.5%), surveillance/preventive measures recommended for LS (24.1%) or FAP (37.1%). Only about 40% of physicians identified CRC at age 45 and metachronous CRC and endometrial cancer (EC) after age 60 as criteria for LS evaluation, whereas 29.3% (34/116) recommended genetic counseling in case of 20 adenomatous polyps in a 70 year old individual. Less than a third (37/116; 31.9%) of all participants accurately calculated the probability of carrying a *MLH1* mutation for a second-degree relative in a family with a known mutation. A small proportion of responders correctly estimated cumulative CRC and EC risks for female *MLH1* mutation carriers, with a better performance for specialists (gastroenterologists, surgeons and oncologists) vs. primary care physicians/internists (50.0% vs. 20.0% for CRC risk; p=0.002 and 34.6% vs. 14.4% for EC risk; p=0.020). Only 14/26 (53.8%) of specialists recommended appropriate colonoscopy interval in LS carriers.

Conclusion: Important knowledge gaps in appropriate referral, counseling, and optimal management recommendations were identified among non-geneticist physicians. These findings highlight the need for improving knowledge in medical genetics for physicians in private practice and stress the importance of a closer collaboration with medical geneticists to adequately manage individuals concerned with CRC predisposition syndromes.

PP116 - ELUCIDATING THE MOLECULAR BASIS OF MSH2-DEFICIENT TUMORS BY COMBINED GERMLINE AND SOMATIC ANALYSIS

G. Vargas¹, M. González-Acosta¹, B. A. Thompson², C. Gázquez¹, A. Fernández¹, E. Dájmaso¹, T. Pons³, M. Morak⁴, J. del Valle¹, S. Iglesias¹, A. Velasco⁵, A. Solanes¹, X. Sanjuan⁶, N. Padilla⁷, X. de la Cruz⁷, A. Valencia³, E. Holiski-Feder⁴, J. Brunet¹, L. Feliubadalá^{3,1}, C. Lázaro¹, M. Navarro¹, M. Pineda¹, G. Capellán¹

¹Hereditary Cancer Program, Catalan Institute of Oncology-IDIBELL L'Hospitalet de Llobregat, Barcelona, Spain, ²Huntsman Cancer Institute, University of Utah School of Medicine Salt Lake City, USA, ³Spanish National Cancer Research Center Madrid, Spain, ⁴Medizinische Klinik und Poliklinik IV Munich, Germany, ⁵Hereditary Cancer Program, Catalan Institute of Oncology-IDIBELL Girona, Spain, ⁶Pathology Department, Bellvitge Hospital L'Hospitalet de Llobregat, Barcelona, Spain, ⁷Vall d'Hebron Research Institute Barcelona, Spain

In a proportion of patients presenting mismatch repair (MMR)-deficient tumors, no germline pathogenic mutations are identified in MMR genes defining the so-called Lynch-like syndrome (LLS). Recently, germline mutations in *POLE* and *MUTYH* and double somatic events in MMR genes have been found in some of these patients. The aim of this study was to elucidate the molecular basis of MSH2-deficient LS-suspected cases using a comprehensive analysis of colorectal cancer (CRC)-associated genes at germline and somatic level.

Fifty-eight probands harboring MSH2-deficient tumors were included. Germline mutational analysis of *MSH2* (including *EPCAM* deletions) and *MSH6* was performed. Pathogenicity of *MSH2* variants was assessed by RNA analysis and multifactorial likelihood calculations. *MSH2* gene cDNA and methylation of *MSH2* and *MSH6* promoters were studied. Matched blood and tumor DNA were analyzed using a customized next generation sequencing panel.

Thirty-five individuals were carriers of pathogenic or probably pathogenic variants in *MSH2* and *EPCAM*, and 5 were carriers of *MSH2* variants of unknown significance (VUS). Two variants at the *MSH6* promoter were identified. Pathogenicity assessment allowed the reclassification of 4 VUS and 6 probably pathogenic variants as pathogenic mutations. Pathogenic germline heterozygous mutations in *BUB1*, *SETD2*, *FAN1* and *MUTYH* were identified in 5 cases. In addition, double somatic hits in *MSH2* or *MSH6* and somatic alterations in other MMR genes and/or proof-reading polymerases were detected.

In conclusion, our comprehensive strategy combining germline and somatic mutational status of CRC-associated genes by means of a subexome panel allows the elucidation of up to 86% of MSH2-deficient suspected LS tumors.

PP117 - UNIVERSAL MSI SCREENING FOR LYNCH SYNDROME IN JAPANESE COLORECTAL CANCER PATIENTS

T. Yamaguchi¹, M. Takao¹, S. Natsume¹, D. Nakano¹, H. Matsumoto¹, K. Takahashi¹, R. Shimizuguchi¹, A. Takao¹, S. Shibata¹, T. Tabata¹, K. Koizumi¹

¹Tokyo Metropolitan Cancer and Infectious diseases Center Komagome Hospital Tokyo

Background and Aim

Universal screening by microsatellite instability (MSI) is useful for screening for Lynch syndrome, and it has been reported that approximately 3% of patients with colorectal cancer are Lynch syndrome. However, because universal screening is not common in Japan, its usefulness has not been clarified. Therefore, the aim of study was to clarify the usefulness of universal screening in Japanese colorectal cancer patients.

Patients and Methods

We consecutively selected 1005 colorectal cancer patients who underwent surgical resection at the Tokyo Metropolitan Cancer and Infectious diseases Center Komagome Hospital from 2008 to 2013 after obtaining informed consent, and assessed microsatellite instability, *BRAF*, and CpG island methylator phenotype (CIMP).

Results

Among the 1005 colorectal cancer patients that we obtained colorectal cancer and normal tissue, MSI status was ascertained in 1004 patients. Of the 1004 patients, 62 patients (6.2%) were categorized as MSI colorectal cancer. Of 62 patients, 24 patients showed *BRAF* mutation, 32 patients showed aberrant hypermethylation of *MLH1* gene, and 25 patients showed CIMP-positive. As the results, XX patients were suspected Lynch syndrome. After genetic counseling, XX of XX patients who received genetic testing were diagnosed Lynch syndrome. In one patient who matched Amsterdam criteria II and whose colorectal cancer did not show MSI tumor, we detected germline mutation of *MSH6* gene. In three patients matching Amsterdam criteria I but showing MSS, malignant tumors except colorectal cancer were not developed, and they were considered to be Familial colorectal cancer type X.

Conclusion

The MSI test was useful for diagnosis of Lynch syndrome, but it should be noted that there are tumors showing MSS even in Lynch syndrome.

PP118 - FINDING YOURSELF IN FRONT OF THE MIRROR: DEVELOPMENT OF A THEORY REGARDING PRESYMPTOMATIC GENETIC TESTING IN YOUNG ADULTS

L. Godino¹, D. Turchetti², L. Jackson³, C. Hennessy³, H. Skirton³

¹Department of Medical and Surgical Sciences, Bologna University Hospital Authority St.Orsola-Malpighi Polyclinic, Genetic Unit, Italy Bologna, Italy; Plymouth, UK, ²Department of Medical and Surgical Sciences, Bologna University Hospital Authority St.Orsola-Malpighi Polyclinic, Genetic Unit, Italy Bologna, Italy, ³School of Nursing and Midwifery, Faculty of Health and Human Sciences, Plymouth University, UK Plymouth, UK

PURPOSE

Genetic counselling is a specialist health service provided to those affected by or at risk of a genetic condition. Presymptomatic genetic testing should always involve a considered choice. Young adults are at a key life stage as they may be developing a career, forming partnerships and potentially becoming parents. The aim of this study was to develop a theoretical model regarding the factors involved when young adults undergo genetic counselling for hereditary cancer risk.

METHODS

A mixed-methods sequential explanatory design was used.

RESULTS

Participants surround themselves with other people who influence their knowledge and awareness. The decision-making process started as a result of the influence of these people and only those young adults who decided to be tested presented for genetic counselling. During genetic counselling they viewed themselves as in front of a mirror. They took distance from themselves and spoke about themselves not in the first but in the second person, especially when they talked about sensitive situations. Finally, they achieved some autonomy and recognised how integrate the test result into their everyday life.

CONCLUSION

Counselling approaches to this population may require modification both for young adults and their parents. Health professionals could have a role in both supporting parents and young adults. It is important to publicise the supportive and educational role of genetic services. The traditional ‘wait until they come to us’ approach by health services may be failing to meet the educational and emotional needs of this population.

PP119 - POLYMERASE PROOFREADING ASSOCIATED POLYPOSIS: A PHENOTYPIC UPDATE

V. Cuthill¹, C. Palles², I. Tomlinson², A. Latchford¹

¹The Polyposis Registry, St. Mark's Hospital London, ²Wellcome Trust Centre for Human Genetics Oxford

Background

Germline mutations in the exonuclease domains of *POLE* and *POLD1* cause polymerase proofreading associated polyposis (PPAP). It is rare and the phenotype incompletely understood. We aim to provide an update on our cohort with PPAP and combine these with the phenotypic data reported in the literature.

Methods

Our original patient cohort has previously been reported. New mutation carriers and new cancer or other significant new clinical features were identified. These patients are carriers of either *POLE*:p.L424V or *POLD1*:p.S478N. A systematic review of the literature was performed to identify other published cases of proven mutation carriers.

Results

In our cohort of 46 patients we have identified seven new mutation carriers. This includes 6 carriers of *POLE* mutations from 3 new families. New cancers that have arisen in *POLE* mutation carriers included: colorectal (CRC) 5 (median age 45 yrs), breast (Br) 3 (57 yrs, 38 yrs and unknown), duodenum (Du) 1 (55 yrs), endometrial (EC) 2 (56 yrs and age unknown), oesophageal (Oes) 1 (70 yrs), BCC (48 yrs), urological (Ur) 1 (age unknown). Other important new phenotypic features included 2 patients with advanced duodenal adenomas requiring endoscopic treatment (34 & 38 yrs). One new *POLD1* mutation carrier was identified but no new cancers or other significant clinical features have arisen.

In the literature, there are 76 *POLE* mutation carriers (38 female; 3 pts gender unknown) from 27 families. 61 carriers had a history of colonic adenomas (4 pts data unavailable), range 1->100 polyps. Duodenal adenomas, where reported, were seen in 11 carriers. There are 46 carriers with 64 CRCs. Other cancers included brain tumour (CNS) (4); Br (1 (female)); Du (3); EC (3); ovarian (Ov) (6 in 5 patients), Ur (1) and pancreatic (2).

24 *POLD1* mutation carriers (16 female, 64%) from 10 families have been reported. Colonic adenomas were seen in 17, number 2-45. 15 carriers had CRC median age 33 years. Other cancers included EC 8 (median age 52); GIST 1; CNS 1 (synchronous at age 26); Br 3 (female)

Table 1 summarises the combined new data from our cohort and all previously published data.

Conclusion

We have identified additional cases of PPAP and have updated the phenotypic description. Agreed surveillance and management protocols are required, given the high risk of gastrointestinal and gynaecological neoplasia.

Table1: Phenotypic features from the combined set of our updated cohort and all previously reported cases

Cancer/Feature	POLE	POLD1
CRC	51/82 (62.2%)	15/25 (60%)

EC	5/41 (12.2%)	8/16 (50%)
Du	4/82 (4.9%)	
Br	5/41 (12.2%)	3/16 (18.8%)
Ov	5/41 (12.2%)	
CNS	4/82 (4.9%)	1/25 (4%)
Pancreatic	2/82 (2.4%)	
Oes	1/82 (1.2%)	
Ur	2/82 (2.4%)	
BCC	1/82 (1.2%)	
Colonic adenomas	61/82 (74.4%)	17/25 (68%)
Duodenal adenomas	13/82 (15.9%)	

PP121 - IDENTIFICATION AND FUNCTIONAL CHARACTERIZATION OF A CDH1 MISSENSE VARIANT IN THREE UNRELATED FAMILIES WITH GASTRIC CANCER

L. Pena¹, J. Perea², S. Melo³, F. Mercadillo¹, J. Figueiredo³, J. M. Sanches⁴, A. Sınchez-Ruiz⁵, L. Robles², R. Seruca³, M. Urioste¹
¹Spanish National Cancer Centre Madrid, Spain. , ²12 de Octubre University Hospital Madrid, Spain. , ³Instituto de Investigao e Inovao em Sade (i3S), University of Porto. Porto, Portugal, ⁴ Institute for Systems and Robotics, Instituto Superior Tcnico. Lisboa, Portugal. , ⁵Puerta de Hierro University Hospital. Madrid, Spain.

Identification and functional characterization of a CDH1 missense variant in three unrelated families with gastric cancer

Laura Pena* (1), Jos Perea* (2), Soraia Melo (3, 4, 5), Ftima Mercadillo (1), Joana Figueiredo (3, 4), Joo Miguel Sanches (6), Antonio Snchez-Ruiz (7), Luis Robles (8), Raquel Seruca (3, 4, 5), Miguel Urioste (1, 9).

- (1) Familial Cancer Clinical Unit, Spanish National Cancer Research Centre (CNIO), Madrid, Spain;
- (2) Surgery Department, and Digestive Cancer Research Group, University Hospital 12 de Octubre, Madrid, Spain;
- (3) Instituto de Investigao e Inovao em Sade (i3S), University of Porto, Porto, Portugal;
- (4) Institute of Molecular Pathology and Immunology of the University of Porto (IPATIMUP), Porto, Portugal;
- (5) Medical Faculty of the University of Porto, Porto, Portugal;
- (6) Institute for Systems and Robotics, Instituto Superior Tcnico, Lisboa, Portugal;
- (7) Medical Oncology Service, Hospital Universitario Puerta de Hierro, Madrid, Spain;
- (8) Medical Oncology Service, Hospital Universitario 12 de Octubre, Madrid, Spain;
- (9) Centre for Biomedical Network Research on Rare Diseases (CIBERER), Madrid, Spain.

* These authors contributed equally to this work.

Germline mutations in the *CDH1* tumor suppressor gene are associated to the condition of Hereditary Diffuse Gastric Cancer (HDGC), which predisposes to a higher risk to develop diffuse gastric cancer and lobular breast cancer. Given the aggressiveness of gastric cancer, prophylactic gastrectomy is usually considered in carriers of *CDH1* pathogenic mutations. Nevertheless, management of patients is a complicated issue when it comes to missense variants, being necessary the assessment of the functional impact in the E-cadherin protein.

In the present work, we have identified three unrelated Spanish families with HDGC that harbored the same missense variant of uncertain clinical significance. Segregation of the variant with the disease in the three families and population frequency data suggested a pathogenic outcome of the genetic change found. The consequent amino acid shift disrupts a consensus NST sequence located in the fourth cadherin domain and required for N-glycosylation, a relevant modification for proper E-cadherin status. Consistent with this, *in silico* analysis predicted the variant as deleterious. Results of *in vitro* approaches also supported this hypothesis by revealing an impairment in the protein's ability for cell aggregation and a irregular pattern of E-cadherin expression, together with an increased invasive ability of mutant cells.

Therefore, our work demonstrates the pathogenic effect of the variant found and hence allows us to accomplish an accurate genetic counseling in the three families. The possible recurrence and founder origin of the variant are also discussed.

PP124- NATURAL HISTORY OF COLONIC POLYPOSIS IN CHILDREN AND YOUNG ADULTS WITH FAMILIAL ADENOMATOUS POLYPOSIS (FAP)

S. Sarvepalli¹, C. Burke², R. Lopez², L. Laguardia², M. O'Malley², J. Church²

¹Medicine Institute, Cleveland Clinic Cleveland, Ohio, USA, ²Sanford R. Weiss MD Center for Hereditary Colorectal Neoplasia, Digestive Diseases Institute, Cleveland Clinic Cleveland, Ohio, USA

Introduction

Surgery is the standard treatment for prevention of colorectal cancer in FAP. A significant increase in number of polyps is an indication for colectomy. Limited information is available on the natural history of colorectal polyposis in children and young adults. This study examined progression of polyp number and size, and factors associated with polyposis progression.

Methods:

The records of all FAP patients < 30yrs were obtained from the David G. Jagelman Inherited Colorectal Cancer Registry Cologene™ database. Patients with ≥2 colonoscopies were included. Average annual polyposis rate (AAPR) and average annual change in polyp size (AACPS) were calculated by subtracting number and size (respectively) of polyps between consecutive colonoscopies and dividing it by time elapsed between them. Patients were divided into three groups according to the number of polyps at baseline: Group 1 (0-20), Group 2 (21-99), and Group 3 (>99) and by genotype predicted colonic phenotype according to InSIGHT's LOVD database (classic, severe, attenuated and uncharacterized). Clinical features and polyp characteristics on polyposis progression were analyzed. Demographic, clinical, and endoscopic factors associated with AAPR and AACPS were analyzed by X²-analysis and ANOVA. Bonferroni correction was used for pairwise post-hoc comparisons.

Results

67 patients with a mean age of 12.1 years and 3 years of follow up were included (Table 1). Median AAPR varied between groups: Group 1=4.8, Group 2=9.8, Group 3=59.5 (Figure 1, Table 1). AAPR also varied by genotype predicted phenotype: Attenuated= 5.3, Classic=9.8, Severe=153.1 (Figure 2, Table 2). No clinical increase in polyp size or differences in AAPC between groups was noted. Colectomy was required in 11%, 39% and 59% (p=0.003) of patients at an average age of 18, 17 and 13 years (p<0.001) in Group 1, 2, and 3, respectively. Significant differences were noted between groups 1, 2 and 3 in age, height, weight, size of polyps, progression of polyps in first year, and interval between colonoscopies. Large or histologically advanced polyps occurred rarely.

Conclusion

In children and young adults with FAP, the number of polyps at initial colonoscopy and genotype can predict progression of polyposis, frequency and timing of surgical intervention. This data can help clinicians better prognosticate the disease course in FAP and help families and patients make informed decisions regarding the timing of colectomy.

TABLE 1- Characteristics of Patients

Factor	Overall (N=67)		0-20 polyps (N=27)		21-99 polyps (N=23)		100+ polyps (N=17)		P-value
	N	Statistics	n	Statistics	n	Statistics	n	Statistics	
Gender	67		27		23		17		0.79 ^c
- Female		32(47.8)		13(48.1)		12(52.2)		7(41.2)	
- Male		35(52.2)		14(51.9)		11(47.8)		10(58.8)	
Age at first colonoscopy	67	12.0±2.5	27	12.0±2.5	23	12.8±1.9 ^a	17	10.8±1.6 ^b	0.043 ^a
Height at first colonoscopy (cm)	59	150.4±15.1	26	149.3±14.5	19	157.9±13.5 ^a	14	142.1±13.0 ^b	0.009 ^a
Weight at first colonoscopy (kg)	59	47.3[36.4,57.7]	26	48.2[38.6,63.2]	19	50.9[45.9,71.4] ^a	14	37.5[30.9,44.5] ^b	0.009 ^a
BMI percentile at first colonoscopy	59	77.0[48.8,95.4]	26	82.2[69.8,96.4]	19	75.2[49.2,95.0]	14	51.7[17.4,87.3]	0.11 ^b
Family history of FAP	67	>1(76.1)	27	20(74.1)	23	18(78.3)	17	13(76.5)	0.94 ^c
1st degree family history of FAP	66	50(75.8)	27	20(74.1)	22	17(77.3)	17	15(76.5)	0.96 ^c
InSIGHT Genotype-Phenotype correlation, if tested	59		23		20		16		<0.001 ^a
- Attenuated		6(10.2)		6(26.1) ^a		0(0.0) ^b		0(0.0) ^b	
- Classic		27(45.8)		13(56.5)		11(55.0)		5(18.8)	
- Severe		10(16.9)		0(0.0)		1(5.0)		9(56.3)	
- Uncharacterized		16(27.1)		4(17.4)		8(40.0)		4(25.0)	
Number of polyps at first colonoscopy	67	30.0[10.6,100.0]	27	7.0[2.0,14.0] ^{2a}	23	45.0[27.0,60.0] ^{2a}	17	119.0[100.0,303.0] ^{2a}	<0.001 ^a
Average size of polyps at first colonoscopy	67	2.3[2.0,3.0]	27	2.0[1.9,2.6] ^a	23	2.4[2.0,3.0]	17	3.0[2.0,3.0] ^b	0.004 ^a
Surveillance									
Follow-up (years)	67	3.1[2.6,4.6]	27	3.8[2.0,5.3] ^a	23	3.9[2.7,5.3] ^a	17	2.5[1.4,2.9] ^b	0.003 ^a
Number of colonoscopies/patient	67	4.0[2.6,4.0]	27	4.0[2.0,5.0]	23	4.0[2.0,5.0]	17	3.0[2.0,4.0]	0.13 ^b
Average time elapsed between colonoscopies	67	1.1[0.98,1.4]	27	1.3[1.04,1.5] ^a	23	1.08[0.98,1.3]	17	0.98[0.93,1.1] ^b	0.004 ^a
Colectomy	67	22(32.8)	27	3(11.1) ^b	23	9(39.1)	17	10(58.8) ^c	0.003 ^a
- Age at colectomy (yrs)	22	15.4±2.5	3	18.2±1.9 ^a	9	16.7±1.5 ^a	10	13.2±1.5 ^b	<0.001 ^a
Presence of high grade dysplasia	67	1(1.5)	27	0(0.0)	23	1(4.3)	17	0(0.0)	0.60 ^a
Presence of tubulovillous or villous adenomas	67	1(1.5)	27	1(3.7)	23	0(0.0)	17	0(0.0)	0.99 ^a
Presence of polyps > 10mm	67	5(7.5)	27	1(3.7)	23	3(13.0)	17	1(5.9)	0.52 ^a
Increase in polyps in the first year	67	4.9[0.99,35.8]	27	0.67[-2.1,13.0] ^a	23	4.3[0.90,11.4] ^a	17	101.7[9.3,422.6] ^{2a}	0.003 ^a
Average number of polyps removed/colonoscopy	67	2.1[0.56,5.7]	27	1.6[0.50,4.0]	23	3.5[1.3,7.0]	17	3.0[0.60,6.0]	0.13 ^b
Size of the largest polyp (mm)	66	6.0[4.0,7.0]	27	5.0[4.0,6.0]	23	6.0[5.0,8.0]	16	5.5[3.0,10.0]	0.47 ^b
Average annual polyposis rate (AAPR)	67	0.5[0.32,25.9]	27	4.8[-0.10,11.0] ^a	23	9.8[0.82,24.5]	17	59.5[9.3,287.3] ^a	0.003 ^a
Average annual change in polyp size (AACPS)	67	0.02[-0.02,0.31]	27	0.02[-0.10,0.61]	23	0.08[-0.00,0.20]	17	0.00[-0.01,0.21]	0.72 ^b

Statistics presented as Mean ± SD, Median [P25, P75] or N (column %).

p-values: a=ANOVA, b=Kruskal-Wallis test, c=Pearson's chi-square test, d-Fisher's Exact test.

¹: Significantly different from 0-20 polyps

²: Significantly different from 21-99 polyps

³: Significantly different from 100+ polyps

Bonferroni correction was used pairwise post-hoc comparisons.

FIGURE 1- Comparison of AAPR based on number of polyps present at baseline colonoscopy

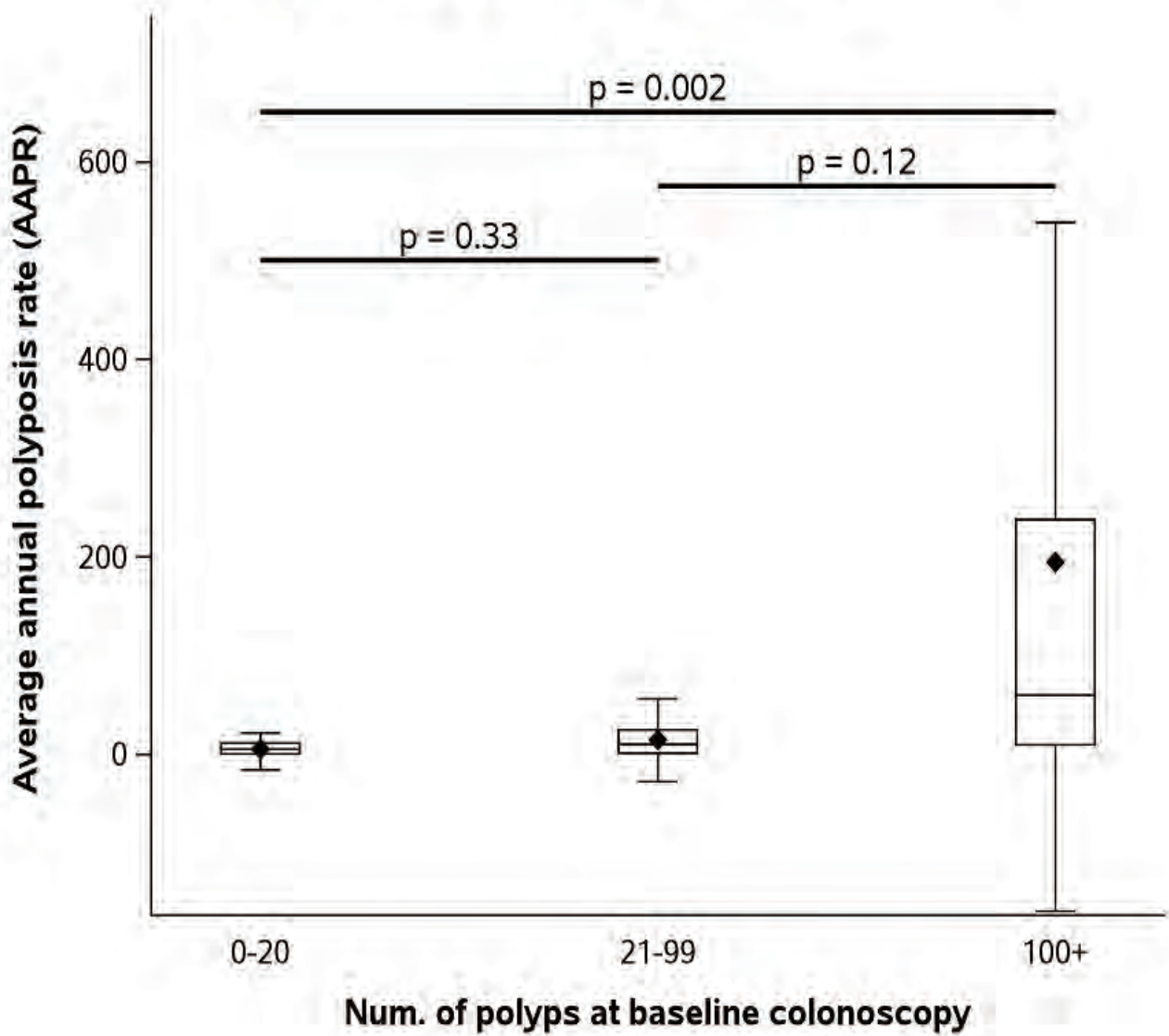

TABLE 2- Characteristics of Patients by colonic phenotype in LOVD that corresponds to patient's genotype

Factor	Attenuated (N=6)		Classic (N=27)		Severe (N=10)		p-value
	n	Statistics	n	Statistics	n	Statistics	
Gender	6		27		10		0.20 ^d
Female		5(83.3)		12(44.4)		4(40.0)	
Male		1(16.7)		15(55.6)		6(60.0)	
Age at first colonoscopy	6	12.0±2.8	27	12.5±2.9	10	10.2±1.3	0.068 ^a
Number of polyps at first colonoscopy	6	9.0[5.0,14.0] ³	27	21.0[9.0,45.0] ³	10	176.0[100.0,505.0] ¹²	<0.001 ^b
Average size of polyps at first colonoscopy	6	2.0[2.0,2.2]	27	2.2[2.0,3.0]	10	3.0[2.0,3.0]	0.14 ^b
Follow-up (years)	6	2.5[1.3,3.8]	27	3.6[2.5,6.9] ³	10	2.6[1.1,3.0] ²	0.032 ^b
Number of colonoscopies/patient	6	2.5[2.0,4.0]	27	4.0[3.0,6.0]	10	3.0[2.0,4.0]	0.10 ^b
Average time elapsed between colonoscopies	6	1.3[1.07,1.4]	27	1.2[1.01,1.4] ³	10	0.98[0.95,1.01] ²	0.028 ^b
Colectomy	6	0(0.0)	27	8(29.6)	10	6(60.0)	0.045 ^d
AAPR	6	5.3[0.32,14.2] ³	27	9.8[0.82,17.4] ³	10	153.1[55.9,538.1] ¹²	0.005 ^b
AACPS	6	0.00[-0.16,0.00]	27	0.08[-0.05,0.40]	10	0.00[0.00,0.34]	0.45 ^b

Statistics presented as Mean ± SD, Median [P25, P75] or N (column %).

p-values: a=ANOVA, b=Kruskal-Wallis test, d=Fisher's Exact test.

¹: Significantly different from Attenuated

²: Significantly different from Classic

³: Significantly different from Severe

Bonferroni correction was used for pairwise post-hoc comparisons.

FIGURE 2- Comparison of AAPR based on patient's genetic testing

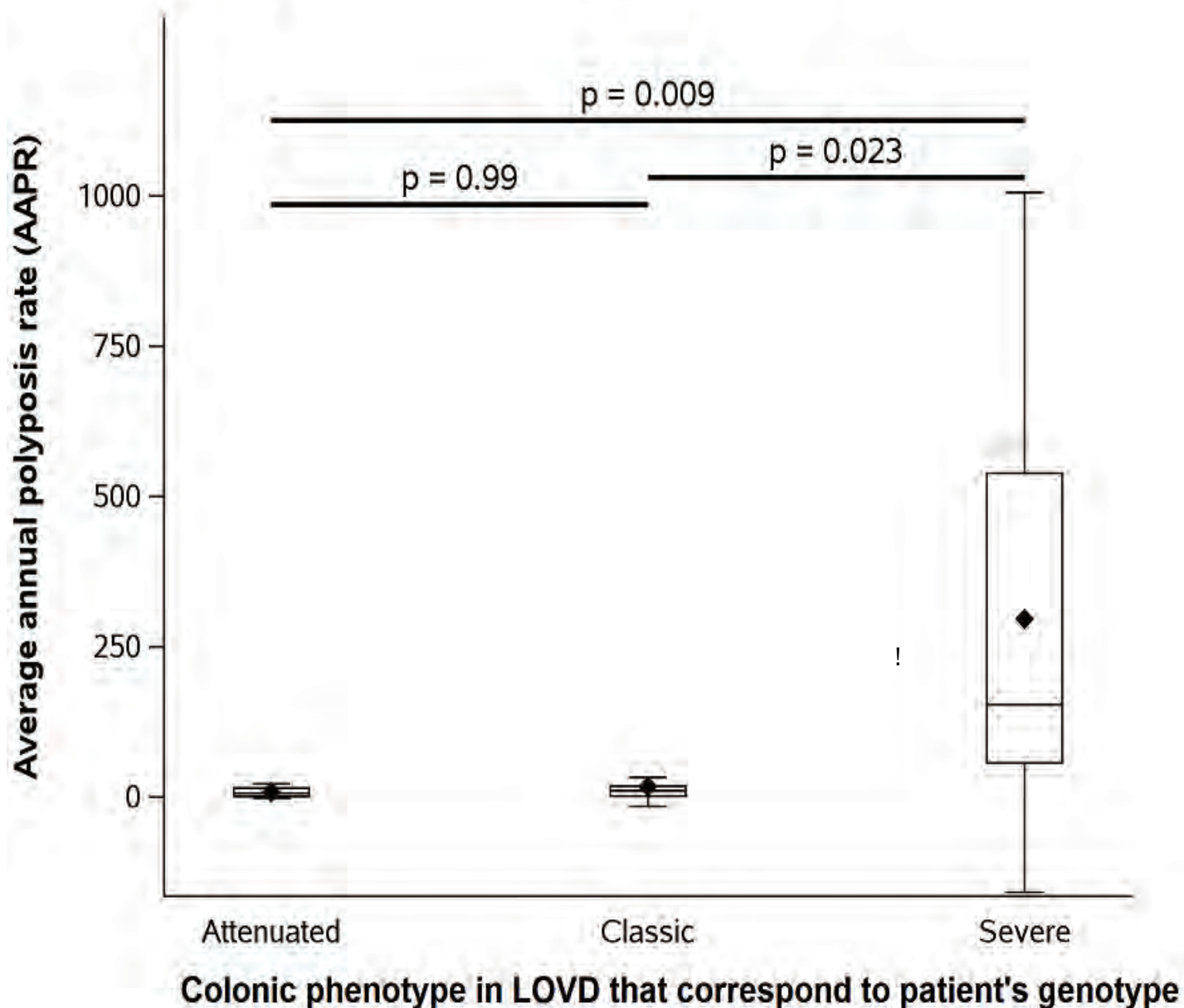

PP125 - RELATIONSHIP BETWEEN LYNCH SYNDROME AND INFLAMMATORY BOWEL DISEASE- ASSOCIATED COLORECTAL CANCER

J. Perea¹, A. Vivas¹, C. Sınchez¹, D. Rueda¹, M. Arriba², L. Brandıriz¹, Y. Rodrıguez¹, L. Pena³, J. L. Garcıa⁴, R. Gonzılez-Sarmiento⁴, M. Urioste³

¹12 de Octubre University Hospital. Madrid. Spain, ²Gregorio Maraın University Hospital Madrid. Spain, ³Spanish National Cancer Centre Madrid. Spain, ⁴Instituto de Investigaciın Biomédica de Salamanca (IBSAL) Salamanca, Spain

AIMS. To define and characterize cases of Lynch syndrome (LS) within a subset of Inflammatory Bowel Disease (IBD)-associated colorectal cancers (CRC).

MATERIAL AND METHODS.

We identified IBD-colorectal cancer cases diagnosed in our institution, collecting both cancer and IBD features (clinic-pathological and familial). We carried out Microsatellite Instability (MSI) analysis and, if positive, we analyzed if they were sporadic (BRAF mutations and/or *MLH1* gene promoter hypermethylation) or LS (DNA Mismatch Repair (MMR) genes germline mutations). We compared the characteristics of LS cases with the other IBD-associated CRC.

RESULTS. From a total of 32 IBD-associated CRC, 18 were within Crohn's disease (CD) (56%), and the rest were within Ulcerative colitis. Only one case showed MSI, due to a germline MMR mutation in *MLH1* (c.1847delA), and was in a CD patient. She developed CRC at an age of 55 y/o in the right colon, fulfilling her family Amsterdam type I criteria. Remarkably, she developed CD 20 years later (A3L3B1 from Montreal classification), with a mild course. Compared with the other CD-associated CRC, these were diagnosed at a mean age of 55 y/o, mainly located in the right colon (54%), but with an important mucinous component (42%), and with a 42% of cases showing CRC Familial history. The progression of the CD was not as mild, with 30% showing extraintestinal manifestations, and being most of them diagnosed before the CRC (81%, mean: 8 years).

CONCLUSIONS.

Against expected, we found almost no MSI implication in IBD-associated CRC. Only one case was defined as LS, and the CRC arose long time before CD, making us think that the association between both entities is by chance. Larger series are needed to confirm these findings.

PP127 - RAPID ASSESSMENT OF THE ACCEPTABILITY OF A WEB-BASED, PROVIDER-MEDIATED TOOL FOR COMMUNICATING CANCER GENETIC RISK FINDINGS TO AT-RISK RELATIVES

M. Pande¹, S. Peterson², P. Lynch¹

¹Gastroenterology, Hepatology & Nutrition Houston, ²Behavioral Science Houston

Background: Identification of at-risk relatives of persons with conditions such as Lynch syndrome (LS) is key to genetic “cascade” testing and surveillance to prevent cancer. Existing standards of care place responsibility on the index patient for sharing genetic test results with relatives. This is haphazard and usually limited to first degree relatives. In response, we have developed a web-based program, “FamilyCONNECT”, a provider mediated, patient-navigated, low-resource, online tool for family outreach. Our aim was to assess the usability and acceptability of FamilyCONNECT by surveying LS patients and families.

Approach: We partnered with Lynch Syndrome International (LSI), a LS advocacy group, to anonymously survey members through a link on their website. This RedCap survey included screenshots of each feature of FamilyCONNECT, questions/comment boxes for feedback about key features: email invite to at-risk relative, authentication of invited relative, secure account creation, consent to share/receive family information & genetic test results, pedigree expansion and provision of health information about additional at-risk relatives, contact information for such relatives.

Results: 170 LSI members participated in the survey during Sept-Nov 2016, with 33% completion rate. A sharp drop in participation (66%) was observed at the informed consent (IC) field. The lengthy IC was rated unfavorably (mean of 43 on a sliding scale from 0-100). For other key features, 87% favored receiving the email invite, 93% found the authentication field acceptable, 79% were agreeable to having the genetic test reports display index patient’s name, 100% recognized a pedigree and 98% felt that it was desirable to have pedigrees show cancer and mutation information about all relatives, including distant relatives not known to them.

Conclusion: Partnering with the target population of end-users we obtained rapid feedback about the acceptability and usability of web-based family outreach, which will guide further refinement of FamilyCONNECT. Key negative feedback was for the informed consent, suggesting that the lengthy boiler-plate language may need to be simplified for online use. A similar survey of potential institutional users (genetic counselors) is underway. Although compliance lawyers helped address HIPAA compliance during development of FamilyCONNECT, we acknowledge that different privacy/confidentiality issues may be a barrier to users in the US and overseas.

PP128 - COWDEN SYNDROME CAUSED BY LOW LEVEL MOSAICISM

I. barnes kedar¹

¹*genetics israel*

Cowden syndrome caused by low level mosaicism

Inbal Barnes-Kedar¹, Zohar Levi², Dani Berkovich³, Angela Jacobson⁴, Collin C Pritchard⁴, Tom Walsh⁴ and Yael Goldberg¹.

¹Raphael Recanati Genetics Institute, Rabin Medical Center, Beilinson Hospital, Petah Tikva, Israel.

²Department. of Gastroenterology, Rabin Medical Center, Beilinson Hospital, Petah Tikva, Israel.

³GGA Galil Genetic analysis, Kazirin, Israel

⁴Department of Laboratory Medicine, University of Washington, Seattle, USA

Introduction: Cowden syndrome (CS) is a cancer predisposition syndrome, part of the PTEN hamartoma syndromes, characterized by an increased risk for benign or malignant thyroid tumors (mainly follicular), breast, endometrial and renal cancer. Individuals with CS may have macrocephaly, trichilemmomas and papillomatous papules. The main gene known to cause CS is the PTEN gene.

Case description: A 47 years old woman of Ashkenazi Jewish descent was referred to our Onco-genetics clinic by oral surgery clinic for the finding of mucosal papillomatosis and the possibility of CS. A tongue biopsy revealed multiple fragments of epithelial hyperplasia. Recently she was diagnosed with thyroid cancer and pathology reports indicated a follicular variant of papillary carcinoma. An endometrial polyp was removed and diagnosed as complex hyperplasia with moderate atypia. Colonoscopy detected several polyps, one of them adenoma with low grade dysplasia and gastroscopy revealed glycogenic acanthosis. Head circumference measured 59 cm (> 98th percentile). Her family history included her mother with breast cancer at age 68, not a carrier of the 3 Ashkenazi mutations in the BRCA1/2 genes. Her father had CLL at age 78.

Methods: A cascade genetic testing approach was applied. Sanger sequencing of the PTEN gene, followed by MLPA analysis for duplication/deletion mutations in the PTEN and promotor sequencing did not detect a mutation. Deep next generation sequencing on lymphocytes revealed a pathogenic mutation p.Q149X; c.445C>T in the PTEN gene in 22/646 (3%) reads - indicating mosaicism. Further testing to other tissues could clarify whether this mutation may be causing mosaic CS.

Conclusion: We report low level mosaicism causing classic CS. Mosaicism should be evaluated by deep sequencing when the phenotype fits clinical criteria, even with normal Sanger sequencing.

PP129 - A MUCINOUS COMPONENT IN COLORECTAL CANCER WITH LYNCH SYNDROME

S. Natsume¹, M. Takao¹, H. Kawamura¹, Y. Nakayama¹, D. Nakano¹, H. Matsumoto¹, K. Takahashi¹, T. Iijima¹, R. Wakaume¹, M. Miyaki¹, T. Yamaguchi¹

¹*Department of surgery Bunkyo-ku*

Aim

Lynch syndrome (LS) is an autosomal dominant disorder caused by germline mutations in one of the mismatch repair genes. Histologically, mucinous component characterized by extracellular mucin is frequently observed in colorectal cancer (CRC) with LS. The aim of this study is to clarify the clinical significance of mucinous component in colorectal cancer with LS.

Patients and Methods

We consecutively selected 1338 colorectal cancer patients who underwent surgical resection. CRC with mucinous component and mucinous carcinoma was defined as 10–50% of extracellular mucin and more than 50% of extracellular mucin, respectively. If a patient had two or more colorectal tumors resected, the more advanced tumor was selected for analysis. Clinical information was collected either from medical records or directly from patients.

Results

A total of 28 cases was diagnosed CRC with LS. Among 28 cases, 10 cases (35.7%) were CRC with mucinous component and 18 cases (64.3%) were CRC without mucinous component. Of 10 cases, 2 cases were diagnosed as mucinous carcinoma. Frequency of LS in CRC with mucinous component was significantly higher than that in CRC without mucinous component ($p=0.019$). There was no significant difference in clinicopathological findings (e.g. age, gender, tumor location, stage, lymph node metastasis, distant metastasis, venous invasion, lymphatic invasion and curability) between CRC with a mucinous component and CRC without a mucinous component in patients with LS. However, in overall survival analyses, patients with mucinous component had significantly poorer prognosis than patients without mucinous component in LS ($p=0.027$).

Conclusion

Mucinous component was poor prognostic factor in CRC patients with LS.

PP130 - CHROMOENDOSCOPY IN COMBINATION WITH RANDOM BIOPSIES DOES NOT IMPROVE DETECTION OF GASTRIC CANCER FOCI IN CDH1 MUTATION POSITIVE PATIENTS

R. HÄneburg¹, T. Marwitz¹, P. van Heteren¹, J. Trebicka¹, T. J. WeismÄller¹, R. Adam², S. Aretz², D. Pantelis³, J. C. Kalff³, A. Perez Bouza⁴, J. Nattermann¹, C. P. Strassburg¹

¹Department of Internal Medicine, Center for hereditary tumor syndromes, University Hospital Bonn Bonn, Germany, ²Institute for Human Genetics, Center for hereditary tumor syndromes, University Hospital Bonn Bonn, Germany, ³Department of Surgery, Center for hereditary tumor syndromes, University Hospital Bonn Bonn, Germany, ⁴Institute of Pathology, Center for hereditary tumor syndromes, University Hospital Bonn Bonn, Germany

Background and study aims

Hereditary diffuse gastric cancer (HGGC), an autosomal dominant tumor-syndrome, accounts for 1-3% of gastric cancers worldwide. Presumably 30-40% of all patients fulfilling the clinical guidelines for HDGC are carriers of a pathogenic mutation in the CDH1 gene. Patients often show multiple foci of signet ring cell carcinoma at early age and are advised to undergo prophylactic total gastrectomy (PTG). Our aim was to improve the endoscopic detection of HDGC by using an enhanced endoscopic protocol.

Patient and methods

Patients with a proven CDH1 germline mutation identified in our institute were prospectively included. Patients were advised to undergo PTG and offered a baseline endoscopic examination prior surgery. Examination was performed by using high-resolution white-light endoscopy and pan-gastric chromoendoscopy with indigo carmine as dye combined with targeted and multiple random biopsies assessed by an expert histopathologist. Postoperative histopathology was compared with results from endoscopic biopsies.

Results

Between September 2012 and November 2014 8 patients with a proven CDH1 germline mutation were included. We conducted 44 targeted (6.3/patient) and 225 random (32.1/patient) biopsies in 7 patients. We detected one gastric cancer by random biopsy (14%). All other examinations showed no signs of cancer. Histopathology of gastrectomy specimen revealed multiple foci of gastric carcinoma in 6 patients (86%) with a total number of 27 cancer foci.

Conclusions

Examination with targeted and random biopsies combined with chromoendoscopy is not able to detect small foci of gastric cancer in CDH1 mutation carriers. Therefore PTG is advocated in these patients.

PP131 - COLORECTAL CANCER IN A 16-YEAR-OLD FEMALE WITH A DE NOVO PMS2 MUTATION

S. H. Erdman¹, K. Zajo², E. Varga², P. C. Minneci³, S. I. Vear²

¹Div of Gastroenterology, Nationwide Children's Hospital Columbus, OH USA, ²Div of Hematology/ Oncology/BMT, Nationwide Children's Hospital Columbus, OH USA, ³Dept of Pediatric Surgery, Nationwide Children's Hospital Columbus, OH USA

Colorectal Cancer in a 16-Year-Old Female With a *de novo* PMS2 Mutation

Steven H. Erdman, Kristin Zajo, Elizabeth Varga, Peter C. Minneci, Susan I. Vear. Divisions of Gastroenterology, Hepatology and Nutrition, Hematology/Oncology/BMT, Departments of Pediatrics and Pediatric Surgery, Nationwide Children's Hospital and the Ohio State University College of Medicine. Columbus Ohio, USA.

Pediatric colorectal cancer (CRC) is uncommon and often discovered at an advanced stage with poor outcome. This rare and ominous diagnosis strongly suggests the presence of a genetic predisposition or cancer syndrome. Lynch Syndrome, the most common heritable colon cancer syndrome, is thought to be most commonly inherited from an affected parent with a very low incidence of spontaneous mutation. We report a case of a 16 year old female presenting with two month history of LUQ abdominal pain that was found to have a poorly differentiated Stage IIA mucinous CRC in the mid transverse colon. Immunohistochemistry on endoscopic biopsy samples suggested loss of MSH2 and MSH6 staining. She underwent an extended left hemicolectomy with tumor staging T3 N0 M0 (97 negative nodes). Her family cancer history was unremarkable and she underwent 17 gene next generation sequencing panel testing (ColoNext) in peripheral blood with identification of a c.1786_1788delAAT deletion of MSH2. Further evaluation following surgery did not identify additional polyps or cancers in her digestive tract or other organs. During the 20 months since her initial surgery her only issue has been an anastomotic stricture requiring repeated balloon dilatation.

Due to the unique nature of her Lynch-associated cancer and concern for other family members that may benefit from surveillance, testing was performed for the MSH2 mutation in peripheral blood from the patient's parents using targeted PCR-based amplification of the relevant coding exon followed by dideoxy termination (Sanger) sequencing. Both parents were negative for the mutation identified in their daughter. Due to the possibility of gonadal or low level mosaicism below the threshold of detection in the parents, targeted mutation analysis was also recommended for the patient's biological siblings. All three biological siblings were subsequently tested through a CLIA certified laboratory and found to be negative for the MSH2 mutation. Her parents deny the possibility of non-paternity and pending confirmation, this appears to be a *de novo* MSH2 mutation/deletion.

Although described as an adult onset cancer syndrome, Lynch-associated CRC can be found in children and adolescents in the absence of a positive family history. This report illustrates the benefits of panel testing in unusual CRC cases lacking an informative family history.

PP132 - MOLECULAR FEATURES OF MICROSATELLITE INSTABILITY-HIGH COLORECTAL CANCER AND MUTATION SPECTRUM OF LYNCH SYNDROME IDENTIFIED BY UNIVERSAL TUMOR SCREENING

K. Akagi¹, M. Kakuta¹, A. Takahashi¹, T. Tachikawa¹, K. Fujiyoshi¹, G. Yamamoto¹, Y. Nishimura², Y. Akagi³, H. Sakamoto²
¹Saitama Cancer Center Molecular Diagnosis and Cancer Prevention Saitama, ²Saitama Cancer Center Surgery Saitama, ³Kurume University Surgery Kurume

Background

Lynch syndrome (LS) is the most common disease in hereditary colorectal cancer (CRC) and is caused by a germline mutation in one of the DNA mismatch repair (MMR) genes. Universal tumor screening (UTS) has some advantages to identify the LS patients, however the details of LS identified by UTS are unknown especially in Asia. Therefore, we performed UTS for colorectal cancer using large cohort and investigated the molecular features of microsatellite instability CRC and germline mutation spectrum of MMR genes in this study.

Methods

Surgically resected 2,563 CRCs were analyzed *KRAS* mutation, *BRAF* mutation and MSI status. Subsequently, CRCs with MSI-H were analyzed methylation status of *MLH1* promoter and germline mutation in MMR genes: *MLH1*, *MSH2*, *MSH6* and *PMS2* by exon sequencing.

Results

Frequency of MSI-H CRC was 5.9% (n=151) among 2,563 CRCs and 52 and 49 MSI-H CRCs had *BRAF* and *KRAS* mutation, respectively. Hypermethylation of *MLH1* promoter was observed 52% (n=79) of MSI-H CRC. The germline mutations of MMR genes were detected in 1.1% (n=27) cases among all CRC cases, 18% cases among all MSI-H CRC cases and 37.5% cases among MSI-H CRC without hypermethylation of *MLH1* promoter. Six were *MLH1* (18%), 10 *MSH2* (39%), 8 *MSH6* (31%) and 3 *PMS2* mutation (11%). *MSH6* mutation carrier were more frequent than western country in Japan.

Conclusion

Prevalence of LS was lower than western countries and mutation spectra of LS in Japan was different from western countries.

PP134 - ISSUES WITH CLASSIFICATION OF AN MSH2 MISSENSE VARIANT ASSOCIATED WITH AN ATYPICAL MUIR-TORRE SYNDROME PHENOTYPE

A. Vaisfeld¹, M. Calicchia², M. G. Pomponi³, L. Reggiani Bonetti⁴, E. Lucci-Cordisco², M. Genuardi¹

¹Istituto di Medicina Genomica, Università Cattolica del Sacro Cuore; UOC Genetica Medica, Fondazione Policlinico Universitario A. Gemelli Rome, ²Istituto di Medicina Genomica, Università Cattolica del Sacro Cuore Rome, ³UOC Genetica Medica, Fondazione Policlinico Universitario A. Gemelli Rome, ⁴Dipartimento di Medicina di Laboratorio e Anatomia Patologica, Università di Modena e Reggio Emilia Modena

A 75-year-old man was referred to the cancer genetics clinic because of personal history of 19 sebaceous neoplasms since the age of 53. He also developed a prostate and a hepatocellular carcinoma at 72 and 73 years, respectively. Colonoscopic evaluations were negative. Family history was negative for sebaceous or internal tumors.

Analysis of *MSH2*, *MSH6* and *MLH1* on leucocyte DNA revealed a heterozygous *MSH2* nucleotide substitution potentially associated with a missense change: c.482T>A p.(Val161Asp). This variant, assigned to Class 3 in the InSiGHT database, is not reported in ExAC. Reduced repair activity was observed *in vitro* (Ollila et al., 2006). Another missense variant affecting the same codon, c.481G>A p.(Val161Ile) has been observed in 2 unrelated patients (<https://www.ncbi.nlm.nih.gov/clinvar/variation/182580/>) and has a frequency of 0.00004942 in ExAC. Amino acid residue 161 is highly conserved and belongs to the *MSH2* connector domain.

Microsatellite instability (MSI) and immunohistochemical (IHC) analyses of the MMR proteins were performed on 1 sebaceous adenoma and 1 carcinoma, which were MSI-L and MSI-H, respectively. IHC showed reduced expression of *MSH2* and *MSH6* in both samples. However, molecular pathology tests on skin sebaceous tumors are not included in the InSiGHT criteria.

This case shows unusual clinical and molecular characteristics. The phenotype is atypical, since the only manifestations in the family are the skin tumors. Although the variant detected is InSiGHT class 3, the IHC results on the sebaceous tumors and the peculiar phenotype of the patient are suggestive of pathogenicity. Notably, the variant is likely pathogenic according to ACMG/AMP criteria.

PP136 - ASSESSING THE CLINICAL VALIDITY OF GENES IMPLICATED IN HEREDITARY COLORECTAL CANCER AND POLYPOSIS USING THE CLINGEN FRAMEWORK

M. Ferber¹, B. Seifert², S. Jackson³, J. McGlaughon², D. Ritter⁴, M. Roberts³, R. Schmidt⁵, S. Jimenez², K. Lee², K. Offit⁶, J. Berg², Z. Stadler⁶, L. Zhang⁶, M. Greenblatt⁷, S. Plon⁴

¹Mayo Clinic Rochester, MN, USA, ²University of North Carolina at Chapel Hill Chapel Hill, NC, USA, ³GeneDx Gaithersburg, MD, USA,

⁴Baylor College of Medicine Houston, TX, USA, ⁵Brigham and Women's Hospital and Harvard Medical School Boston, MA, USA,

⁶Memorial Sloan Kettering Cancer Center New York, NY, USA, ⁷University of Vermont Medical Center Burlington, VT, USA

Recent advances in genomic technologies have fueled an explosion of novel genes proposed to cause hereditary colon cancer. This research grade information has translated to clinical diagnostics in the form of large disease specific panels including some genes that lack proven clinical validity. The Clinical Genome Resource (ClinGen) is an NIH-funded program dedicated to creating a publicly available resource that assesses the clinical relevance of genes and variants within specific diseases. The ClinGen Gene Curation Working Group has established a Clinical Validity framework that facilitates systematic evaluation of literature evidence to assess the strength of a gene's association. This framework is comprised of two major evaluation criteria, clinical and experimental evidence. Each criterion employs a semi-quantitative model which when combined results in a final clinical validity classification for each subject gene: Definitive, Strong, Moderate, Limited, No Reported Evidence, or Conflicting Evidence Reported. Both genetic and experimental evidence is evaluated. Genetic evidence is defined as variants reported in unrelated probands, variant segregation with disease within pedigrees, and association analyses found within case/control studies. Experimental evidence includes assessment of gene function in the relevant disease, functional evaluations of variants, gene expression data, and animal or cell culture models. In this semi-quantitative model, we employ the review of two expert curators for each gene to avoid bias. Following initial curation, the data is reviewed by a disease domain expert panel for final approval of each candidate gene.

Using this framework, the Hereditary Colorectal Cancer and Polyposis Gene Curation Team has evaluated a list of 36 genes found on current clinical testing panels. To date, we have completed curation for 11 of these genes, with GREM1 scoring as "Strong" evidence for hereditary polyposis, AXIN 2 and MSH3 as Moderate, and another eight genes demonstrating "Limited" evidence (BARD1, CDH1, CDKN1B, EPHX1, GALNT12, RPS20, NTHL1, and EXO1). The genes most likely to show Definitive evidence (MLH1, MSH2, MSH6, PMS2, APC, and MUTYH) have not yet been curated.

Ultimately, our hope is that these results will provide a rigorous systematic evaluation that will aid clinicians and laboratorians alike in assessing the clinical relevance of genes they choose to include on hereditary colon cancer panels.

PP137 - ROUTINE MISMATCH REPAIR IMMUNOHISTOCHEMISTRY ANALYSIS AS A VALUABLE METHOD TO IMPROVE LYNCH SYNDROME'S DIAGNOSIS AMONG WOMEN WITH ENDOMETRIAL CANCER

A. Livi¹, D. Turchetti², S. Miccoli², L. Godino², S. Ferrari², R. Zuntini², M. Procaccini¹, A. N. Della Gatta¹, A. De Leo³, C. Ceccarelli³, M. Fiorentino³, D. Santini³, P. De Iaco¹, A. M. Perrone¹

¹Oncologic Gynecology Unit, S. Orsola-Malpighi Hospital, Bologna, Italy Bologna, ²Department of Surgical and Medical Sciences (DIMEC), Medical Genetics Unit, S. Orsola-Malpighi Hospital, Bologna, Italy Bologna, ³Pathology Unit, S. Orsola-Malpighi Hospital, Bologna, Italy Bologna

Introduction & objectives

Since the recommendations of testing based on presence of family history according to Bethesda guidelines or Amsterdam criteria and age (namely, age \leq 50 years) have been shown to be inadequate to properly detect Lynch Syndrome (LS), several guidelines recommend universal screening of colorectal and endometrial cancer by immunohistochemistry (IHC) and microsatellite instability (MSI) testing. The aim of our study was to assess the benefit of screening every woman with EC, in order to improve diagnosis of LS.

Materials & methods

A cohort of 166 consecutive patients who underwent to radical surgical treatment for EC at a single tertiary referral academic institution between September 2014 and December 2016 was evaluated. Routine pathologic analysis in each case included IHC for the mismatch repair (MMR) proteins MLH1, MSH2 and MSH6, followed by MSI testing in inconclusive results and DNA methylation analysis in cases with MLH1 deficiency. Germ-line mutation testing was carried out in every patients with MMR defect except 5 (2 women had deceased, 3 declined genetic testing). Indeed, the germ-line test is in course in 3 individuals. It leads to a final population of 158 patients. Germ-line testing and has been concluded in 26 patients: MLH1, MSH2 and MSH6 mutations were found in 1, 7 and 6 women, respectively.

Categorical variable and means were compared using chi-squared and t-test, respectively.

Results

Table 1 depicts overall patients characteristics. After stratifying according to diagnosis of LS at germ-line test, we found significant differences with regards of age at surgery, body mass index (BMI), pathologic stage and family history of other tumours (all $p\leq 0.008$). Considering age and family history separately, widespread IHC screening allowed to perform germ-line testing in 14 and 12 women that would have been excluded based on age at surgery > 50 years and negative family history, respectively. It resulted in diagnosis of LS in 4 and 4 patients, respectively that would have remained undetected and therefore excluded from colorectal cancer prevention (Table 2). Indeed, considering the combination of two variables, 15 out of 87 individuals (17.2%) that would have been excluded from germ-line testing due to age at surgery > 50 years and negative family history, showed altered IHC analysis. At subsequent germ-line test, 3 out of 15 (21.4%) were diagnosed with LS that otherwise would have remained undetected (Table 2).

Conclusion

Our data suggest that routine IHC screening in every EC patient and subsequent germ-line test according to IHC findings, may improve the diagnosis of LS in almost one out of five cases that would be undetected using traditional predictors such as age at diagnosis and family history.

Table 1

	Overall	Lynch Syndrome No	Lynch Syndrome Yes	p value
Number of patients (%)	158 (100)	144 (91.1)	14 (8.9)	-
Age (years) Mean ± SD	58±12	59 ±12	47± 12	<0.001
BMI (Kg/m²) Mean ± SD	27.3±7	27.8 ±7	22.3±4	0.005
Pathologic stage -FIGO 2009 (%)				0.008
IA				
IB	94 (59.9)	86 (60.1)	8 (57.1)	
II	30 (19.1)	29 (20.3)	1 (7.1)	
IIIA	9 (5.7)	6 (4.2)	3 (21.4)	
IIIB	3 (1.9)	3 (2.1)	0 (0)	
IIIC1	0 (0)	0 (0)	0 (0)	
IIIC2	12 (7.6)	11 (7.7)	1 (7.1)	
IVA	6 (3.8)	6 (4.2)	0 (0)	
IVB	2 (1.3)	2 (1.4)	0 (0)	
	1 (0.6)	0 (0)	1 (7.1)	
Histotype (%)				0.8
Endometrioid	140 (88.6)	128 (88.9)	12 (85.7)	
Mixed	5 (3.2)	4 (2.8)	1 (7.1)	
Dedifferentiated/Indifferentiated	7 (4.4)	6 (4.2)	1 (7.1)	
Serous	5 (3.2)	5 (3.5)	0 (0)	
Clear cells	1 (0.6)	1 (0.7)	0 (0)	
Synchronous ovarian neoplasia (%)				0.2
No				
Yes	140 (89.2)	126 (88.1)	14 (100)	
	17 (10.8)	17 (11.9)	0 (0)	
Personal history of other tumours(%)				0.8
No	131 (82.9)	117 (81.3)	14 (100)	
Yes	27 (17.1)	27 (18.7)	0 (0)	
Family history of other tumous (%)				<0.001
No				
Yes	111 (81.6)	107 (87.7)	4 (28.6)	
	25 (18.4)	15 (12.3)	10 (71.4)	
Endometriosis (%)				0.9
No	123 (77.8)	112 (77.8)	11 (78.6)	
Yes	35 (22.2)	32 (22.2)	3 (21.4)	

Table 2

	Overall	Altered IHC	Lynch Syndrome Yes
Age (%)			
> 50 years	112 (71)	14 (12.5)	4 (29)
= 50 years	46 (29)	12 (26)	10 (71)
Family history (%)			
Negative	111 (81.6)	12 (11)	4 (29)
Positive	25 (18.4)	14 (51.6)	10 (71)
Age > 50 years AND Negative Family history (%)	87 (55)	15 (17.2)	3 (21.4)
Age > 50 years AND Positive Family history (%)	14 (8.9)	3 (21.4)	1 (7.1)
Age = 50 years AND Positive Family history (%)	12 (7.6)	10 (83.3)	9 (64.3)
Age = 50 years AND Negative Family history (%)	31 (19.6)	6 (19.4)	1 (7.1)

PP139 - GERMLINE MUTATIONS IN INDIVIDUALS REFERRED FOR “MULTIPLE” POLYPS

E. Stoffel¹, K. Watkins¹, S. Sengupta¹, E. Koeppel¹, M. Marvin¹

¹*University of Michigan Ann Arbor, MI USA*

~~Purpose: Current U.S. guidelines recommend genetic evaluation for individuals with personal history of >10-20 colorectal polyps. Our aim was to evaluate the utility of polyp number for predicting which individuals carry pathogenic germline mutations associated with hereditary cancer syndromes.

Methodology: We conducted retrospective chart reviews of patients referred to the University of Michigan's Cancer Genetics Clinic on the basis of personal history of colorectal polyps. Total number of genetic tests and positive test results were tallied by year to assess trends over time. Subjects whose genetic tests were performed after 2010 were included in subgroup analyses to test for associations between polyp count and germline findings using Fisher's Exact tests.

Results: 399 probands with personal history of colorectal polyps underwent genetic testing between 2002 and 2016. Mean age at genetic testing was 50 years (range 2-85). An approximate 30-fold increase in genetic referrals and 4-fold increase positive genetic tests were observed during the 15-year span (beginning in 2010). Fifty-eight of 244 (24%) individuals tested between 2010-2016 were found to have pathogenic germline mutations in APC, MutYH, PTEN, CHEK2, MSH2, MSH6, SMAD4, and STK11. Polyp count was positively associated with a positive test result, with germline mutations identified in 14% of subjects with 5-10 polyps, 15% with 10-20 polyps, 10% with 20-50 polyps, 28% with 50-100 polyps, and 76% with >100 polyps ($p < 0.01$). Referral of individuals with 20-50 polyps increased the most dramatically over the study period, while the rate of germline mutations identified in this group was the lowest.

Conclusion: Genetic referral of individuals with multiple colorectal polyps has increased diagnoses of hereditary colorectal cancer syndromes. However, the sensitivity and specificity of polyp count alone as a predictor of genetic risk are limited, particularly in patients with oligopolyposis. Further investigation into clinical features associated with pathogenic germline mutations in patients with 20-50 polyps will help refine risk algorithms and reduce referrals of patients for whom genetic testing is low yield.

PP140 - ROLE OF GENETIC TESTING IN SURGICAL DECISION MAKING FOR PATIENTS WITH HNPCC

L. Duraes¹, M. Kalady¹, B. Leach¹, D. Crowe¹, C. Burke¹, J. Church¹

¹Cleveland Clinic Foundation Cleveland

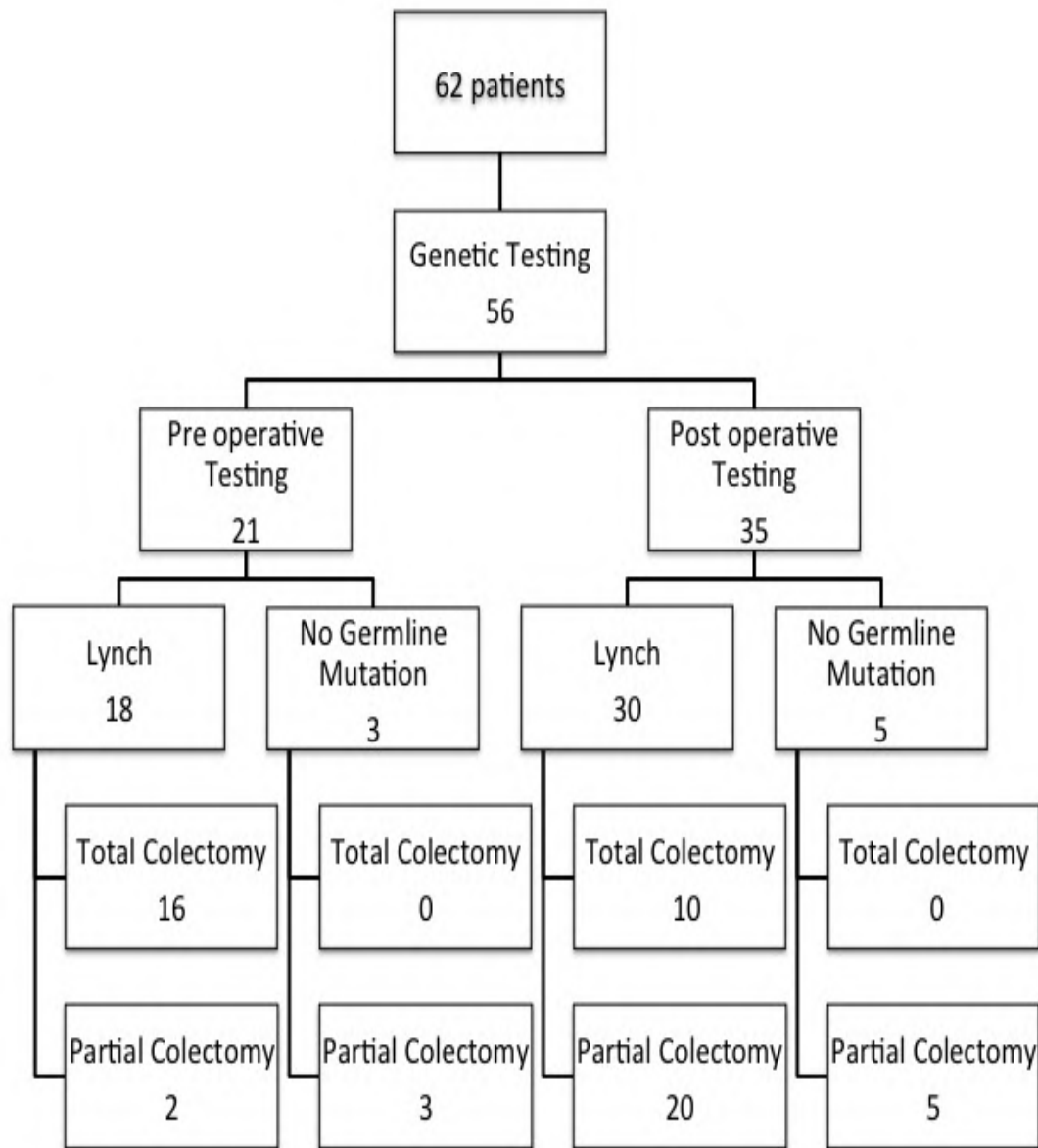

The Amsterdam II family history criteria define a group of families with Hereditary Non Polyposis Colorectal Cancer. Some of these families will have Lynch Syndrome (hereditary mismatch repair deficiency), others will have familial colorectal cancer type X, and others will be just HNPCC. The family history alone confers a high degree of risk for young age of onset colorectal cancer and metachronous colorectal cancer, but the risk can be triaged by germline and tumor testing. While this is routine in some countries in others it is not. Here we aim to evaluate the influence of genetic testing on prophylactic surgical decision-making in patients meeting Amsterdam II criteria.

Methods:

Patients with a family history meeting Amsterdam II criteria who had their index operation in our institution between 2004 and 2014 were included. Patients who had prior colorectal resections in other institutions were excluded. Patients were categorized according to type of surgery and timing of germline genetic testing. Patient characteristics, and surgical outcomes were compared.

Results:

There were 62 patients. One patient had total abdominal colectomy for primary prophylaxis (no cancer), and 61 had cancer at the time of surgery. 26 had total abdominal colectomy and 36 had partial colectomy. 56 (92%) patients had genetic testing for germline mutation: 48 (86%) had Lynch syndrome, and 8 patients had no germline mutation found. 21 patients had genetic counseling and testing before surgery, and 18 had confirmed mismatch repair germline mutation. 16 of the 18 (89%) underwent total abdominal colectomy vs. 10 out of 35 without preoperative genetic testing (29%, $p < 0.001$).

In a median follow-up of 7 years, 5 out of the 36 patients with partial colectomies (14%) developed subsequent metachronous cancer, and had completion colectomies. One patient with previous total colectomy had rectal cancer, and underwent completion proctectomy with ileo pouch-anal anastomosis.

Conclusion

In patients with Amsterdam II criteria preoperative genetic testing is the ideal option to optimize surgical management.

PP143 - DIFFICULTY AND IMPORTANCE OF THE GENETIC COUNSELLING IN HEREDITARY DIFFUSE GASTRIC CANCER.

J. Perea¹, M. Arriba², D. Rueda¹, J. C. Marín¹, L. Pena³, M. Urioste³

¹12 de Octubre University Hospital Madrid, Spain. , ²Gregorio Marañón University Hospital Madrid, Spain. , ³Spanish National Cancer Centre Madrid, Spain.

Difficulty and importance of the genetic counselling in Hereditary Diffuse Gastric Cancer.

José Perea*, María Arriba*, Daniel Rueda, José C. Marín, Laura Pena, Miguel Urioste.

* These authors contributed equally to this work.

Introduction: Gastric cancer (GC) is the fourth most common neoplasm worldwide and the second leading cause of cancer death. Although it has frequently a sporadic nature, it is estimated that about 10% of GCs have a familiar component with about 1-3% being related to known hereditary syndromes, such as familial adenomatous polyposis, Lynch syndrome, Li-Fraumeni syndrome or Peutz-Jeghers syndrome. Hereditary diffuse gastric cancer (HDGC) is an inherited condition which most commonly affected gene is called CDH1. A germline mutation in this gene, encoding the protein E-cadherin and located on chromosome 16q22.1, is identified in approximately 25–40% of individuals with HDGC.

Case report: We present a 41-year-old woman carrier of the mutation W637X in CDH1 with a previous lobular breast carcinoma and diffuse gastric cancer at 32 years of age, mother of two sons also carriers of the mutation W637X. The oldest son was submitted to therapeutic gastrectomy at 20 years of age after endoscopic diagnosis of diffuse gastric adenocarcinoma confirmed in the anatomopathological study. On the contrary, the youngest one decided to undergo prophylactic gastrectomy after reaching 20 years of age, despite his negative endoscopic screening. Unexpectedly, the histological examination of his surgical specimen revealed multifocal diffuse gastric adenocarcinoma.

Discussion: HDGC constitutes an important clinical entity due to its pathogenicity and relatively high penetrance (70–80% lifetime risk for gastric cancer) in which women also have a 39%-52% risk for lobular breast cancer. Although HDGC is an inherited syndrome frequently related with an autosomal dominantly inherited mutation of CDH1, about 60% of families with HDGC have no identifiable germline pathogenic variants in this gene. For this reason, and because HDGC has an insidious nature, currently prophylactic gastrectomy is the option chosen by many members from families felt to be predisposed to gastric carcinoma.

Conclusion: Intense surveillance and care by a multidisciplinary team comprising those with expertise in medical genetics, gastric surgery, gastroenterology, pathology, and nutrition is recommended for the management of individuals who have a CDH1 cancer-predisposing variant.

PP144 - BETA-2 MICROGLOBULIN AS A PROGNOSTIC BIOMARKER IN MISMATCH REPAIR DEFICIENT COLORECTAL CANCER

L. Pearce¹, L. Foster¹, S. Pervez¹, C. Keeling¹, G. Evans¹, J. Hill¹

¹Central Manchester Foundation Trust Manchester

Mismatch repair deficient (dMMR) accounts for approximately 15% of all sporadic colorectal cancer (CRC) and is characteristic of CRC in Lynch Syndrome. Beta-2-microglobulin (B2M) forms part of the HLA class 1 complex and is thought to play an important role in metastatic biology. Data has suggested that frequency of B2M gene mutation decreases with status at pathological stage at presentation, and can protect against recurrence of disease in patients with Stage II colorectal cancer, but this data is limited. This study tests a cohort of dMMR CRC specimens in patients with known MSH2 mutation and compares immunohistochemistry with Sanger sequencing for the detection of B2M mutations.

Methods

Patients with MSH2 mutation who had undergone colorectal cancer resection were identified from the Manchester Regional Genetic Database. DNA was extracted from 56 archived dMMR CRC specimens. Bi-directional Sanger sequencing was performed for the 3 exons of the B2M gene and protein expression was assessed with immunohistochemistry using Anti-β-2-Microglobulin precursor antibody produced in rabbit (B2M).

Results

Results were obtained for 56 dMMR CRC samples. 21/56 (37.5%) contained deleterious B2M mutations. Immunohistochemistry demonstrated 70% sensitivity and 42.86% specificity in the detection of B2M mutations. Positive Predictive value 46.67%, Negative Predictive value 66.67%.

Conclusion

Immunohistochemical testing for B2M mutation testing is insufficient for testing of B2M mutation status in patients undergoing resection for colorectal cancer. In patients where B2M mutation status is required Sanger Sequencing is preferable.

PP145 - MSH2 3'UTR AS PREDICTIVE BINDING SITE FOR THE MIRNA HSA-MIR-137

F. Duraturo¹, R. Liccardo¹, M. De Rosa¹, P. Izzo¹

¹Dept of Molecular Medicine and Medical Biotechnologies, University of Naples "Federico II" Naples

In this work, we reported the results of the study performed to the c.* 226A> G variant detected in the 3'UTR of the MSH2 gene, in order to demonstrate the pathogenicity. First, the c. * 226A> G variant was identified in the index case who developed colon cancer with high microsatellite instability at age 38; he was also belonging to a Lynch syndrome family. The RT-PCR analysis showed that this variant determined an increase of MSH2 mRNA expression; the IHC analysis and by functional luciferase in vitro assay also showed that this variant increased the MSH2 protein levels. Therefore, we performed a computational analysis of this mutation in order to clarify the pathogenetic role. In this manner, we showed that the region in which falls the mutation was identified as a putative target point of miRNAs (as -miR-137). Thus, we speculated that the overexpression effect was related to the loss of MSH2 down regulation from the hsa-miR-137. In order to confirm our hypothesis, the wild-type (WT) and mutant (MUT) MSH2 3'-UTR were cloned downstream the Renilla luciferase reporter gene. The reporter gene constructs were transfected into SW480 cells and 48 hrs later cells were collected for luciferase assay and quantitative mRNA analysis. The MUT MSH2 3'-UTR showed higher luciferase activity than the construct with the WT MSH2 3'UTR. Moreover, using a defined in-vitro miRNA processing system, we also showed that miR-137 regulates MSH2 expression through base pairing with the MSH2 3'-untranslated region. Therefore, the study of c.* 226A> G variant showed that this preventing the binding of miR-137 to the specific MSH2 3'UTR region determines an increase of MSH2 expression. It is known that loss or overexpression of the key mismatch repair proteins leads to genome instability and tumorigenesis, thus, it is likely that this variant is really pathogenic. Moreover, this study also indicates an involvement of miR137 in the pathogenesis of the Lynch syndrome. This is very important as in the next future, the miRNAs may be considered as biomarkers or novel therapeutic targets.

PP146 - THE RISK OF METACHRONOUS COLORECTAL CANCER IN LYNCH SYNDROME: A COMPARISON OF RIGHT COLECTOMY AND LEFT COLECTOMY.

M. Takao¹, T. Yamaguchi¹, S. Natsume¹, D. Nakano¹, H. Matsumoto¹, K. Takahashi¹

¹Department of surgery, Tokyo Metropolitan Cancer and Infectious Diseases Center Komagome Hospital Tokyo, JAPAN

Background: Lynch syndrome (LS) is the most common hereditary colorectal cancer (CRC). It is well known that associated with germline mutations in DNA mismatch repair genes and risk of metachronous CRC. LSCRC likely has right-sided colonic cancer predilection.

Objective: The aim of this study was to clarify metachronous CRC in LS patients after right colectomy compared with those after left colectomy.

Methods: All patients with LS were received appropriate surveillance at a single institution. This is a retrospective, descriptive, cohort study from chart review.

Results: Of 41 patients who underwent colectomy, right colectomy, left colectomy and subtotal colectomy were performed for 17, 18 and 6 patients respectively. In these patients, no metachronous CRC was developed in 18 patients during a mean follow-up of 8.0 years. Of 6 patients after subtotal colectomy, one patient developed rectal cancer. The univariate analysis was found no significant difference in metachronous CRC incidence between the patients after right colectomy and the patients after left colectomy: 11/17 patients (64.7%) and 11/18 patients (61.1%), respectively ($p=1$). The cumulative risk of metachronous CRC after partial colectomy was 32.5% at 5 years, 44.2% at 10 years and 73.4% at 20 years. The cumulative risk of metachronous CRC after right colectomy and left colectomy were 20.2% and 45.0% at 5 years, 42.0% and 45.0% at 10 years ($p=0.71$), respectively. Although the patients who underwent left colectomy has a tendency to develop metachronous CRC earlier, there are no significant differences between these two groups during this observation period. In this study, 4 patients needed to total colectomy because of metachronous CRC after partial colectomy.

Conclusion: The frequencies of metachronous CRC incidences in the patients underwent right colectomy and left colectomy were equivalent. Because of the cumulative risk of metachronous CRC in LS patients is very high, the appropriate surveillance is needed to prevent developing CRC.

PP147 - THE INVESTIGATION OF MALIGNANT TUMORS ASSOCIATED WITH PEUTZ-JEGHERS SYNDROME IN JAPAN

H. Kawamura¹, T. Yamaguchi², H. Matsumoto², D. Nakano², M. Takao², S. Natsume², K. Takahashi², S. Shibata³, T. Tabata³, T. Oonishi³, K. Koizumi³

¹Department of Surgery, Southern TOHOKU General Hospital, Department of Surgery, Tokyo Metropolitan Cancer and Infectious Diseases Center Komagome Hospital Fukushima, Tokyo, ²Department of Surgery, Tokyo Metropolitan Cancer and Infectious Diseases Center Komagome Hospital Tokyo, ³Department of gastroenterology, Tokyo Metropolitan Cancer and Infectious Diseases Center Komagome Hospital Tokyo

• Background and Objectives Peutz-Jeghers syndrome (PJS) is a polyposis syndrome associated with an increased risk of malignancy tumors. The malignant tumor spectrum in Japan is different from Western countries. The aim of this study is to clarify the incidence of malignant tumors associated with PJS in Tokyo Metropolitan Cancer and Infectious Diseases Center Komagome Hospital, Japan. • Methods Clinical data were retrospectively analyzed for the patients who were diagnosed as PJS at Tokyo Metropolitan Cancer and Infectious Diseases Center Komagome Hospital from 1975 August to 2017 January. • Results Eight consecutive patients in three families who diagnosed as PJS were identified. Each family included five patients, two patients, and one patient, respectively. In one of three families, germline STK11/LKB1 gene mutation was identified. The median follow-up period was 91.5 (range 24-437) months. Two patients are alive, two patients were lost to follow-up, and four patients died. The median age at the time of diagnosis of PJS was 13.5 (range 7-26) years old. Six (75%) patients were male. Five patients had at least one malignant tumor. The median age of diagnosis of the first malignant tumor was 46 (range 38-51) years old, and the risk of any malignant tumors was 80% at 40 years old. Three patients had a single malignant tumor, one patient had gastric cancer, breast cancer, and pancreas cancer, and one patient had lung cancer and one pancreas benign tumor. In the site of malignant tumors, three patients had pancreas cancer, two had breast cancer, two had lung cancer, and one had gastric cancer. Histologically, all tumors were adenocarcinoma, and five cases of them were including with mucinous component. The median survival time from diagnosis of malignant tumors was 24 (range 7-152) months. All causes of death were extra-gastrointestinal malignant tumors with mucinous component. • Conclusion Extra-gastrointestinal malignant tumors with mucinous component was common cause of death in Japanese PJS patients.

PP149 - A 14-YEAR-OLD FEMALE WITH ADVANCED RECTAL CANCER, DIAGNOSED WITH LYNCH SYNDROME

M. Takatsu¹, T. Nakajima¹, K. Sugano², S. Sekine³, Y. Aoki⁴, F. Nakatani⁵, K. Takahashi⁶, S. Ikeda⁷, Y. Kanemitsu⁸, M. Ushima¹, N. Tanabe¹, Y. Saito⁹, T. Yoshida¹

¹Genetic Medicine and Services, National Cancer Center Hospital Tokyo, Japan, ²Oncogene Research Unit/Cancer Prevention Unit, Tochigi Cancer Center Research Institute Tochigi, Japan, ³Molecular Pathology Division, National Cancer Center Research Institute Tokyo, Japan, ⁴Pediatric Oncology Division, National Cancer Center Hospital Tokyo, Japan, ⁵Musculoskeletal Oncology and Rehabilitation Division, National Cancer Center Hospital Tokyo, Japan, ⁶Radiation Oncology Division, National Cancer Center Hospital Tokyo, Japan, ⁷Gynecology Division, National Cancer Center Hospital Tokyo, Japan, ⁸Colorectal Surgery Division, National Cancer Center Hospital Tokyo, Japan, ⁹Endoscopy Division, National Cancer Center Hospital Tokyo, Japan

Background: Lynch syndrome (LS) is an autosomal dominant inheritance syndrome caused by a germline mutation of DNA mismatch repair (MMR) gene. LS is characterized by an increased risk for colorectal, endometrial and a variety of other cancers those are more likely to occur at a younger age. We report a 14-year-old female diagnosed with advanced rectal cancer and 5 years later found to carry the *MSH2* gene mutation.

Case report: A 14-year-old female, presented with diarrhoea and hematochezia 5-years ago. A colonoscopy revealed an advanced rectal cancer. She was then referred to our hospital for further staging and treatment. Initial family history revealed that her maternal grandmother had been diagnosed with advanced gastric cancer and cholangiocarcinoma, whilst her maternal grandfather with pancreatic cancer and her maternal great aunt with colon cancer. Amsterdam criteria II were not met. The patient underwent neoadjuvant chemoradiation followed by surgical resection. Pathology revealed a moderately to poorly differentiated adenocarcinoma, stage IIIC, T3N2bM0. Following adjuvant chemotherapy, she remained disease-free for 5 years. Genetic testing was offered at the age of 19, to screen for hereditary cancer syndromes.

Genetic counseling: Genetic counseling was provided to the patient and her parents. Whilst updating the family history it was noted that her mother had been diagnosed with a colonic polyp with high-grade dysplasia at the age of 48 and advanced endometrial cancer at the age of 49. During genetic counseling that concentrated on LS, informed consent was obtained and the patient underwent genetic testing. Immunohistochemistry of MMR protein showed the loss of expression of the MSH2 and MSH6 protein. Genetic testing showed a germ-line mutation of the *MSH2* gene, c.518T>C, p.Leu173Pro, so this patient was finally diagnosed with Lynch syndrome. Genetic testing to her father and mother for the same mutation showed negative and positive result, respectively.

Conclusion: We reported here a rare case of LS associated cancer diagnosed at early 10s. Considering the importance of revised Bethesda guideline, a possibility of LS should be considered for colorectal cancer with early age of onset even without a definite family cancer history. In this family, genetic counseling and genetic testing for her younger siblings should be offered although genetic counseling for 10s generation requires attention.

PP151 - CLINICOPATHOLOGICAL FEATURES OF SERRATED POLYPOSIS SYNDROME IN JAPAN: SINGLE CENTER EXPERIENCE

A. Takao¹, K. Koizumi¹, S. Shibata¹, K. Chiba¹, T. Tabata², S. Kuruma¹, G. Kuwata¹, T. Onishi¹, T. Fujiwara¹, J. Fujiwara², T. Arakawa², M. Kikuyama¹, K. Momma², S. Horiguchi³, T. Yamaguchi⁴

¹Departments of Gastroenterology, Tokyo Metropolitan Komagome Hospital Tokyo, ²Departments of Endoscopy, Tokyo Metropolitan Komagome Hospital Tokyo, ³Departments of Pathology, Tokyo Metropolitan Komagome Hospital Tokyo, ⁴Departments of Surgery, Tokyo Metropolitan Komagome Hospital Tokyo

Introduction. Serrated polyps are classified by the World Health Organization (WHO) into three general categories: hyperplastic polyps (HPs), sessile serrated polyps (SSA/Ps) with or without cytological dysplasia, and traditional serrated adenomas (TSAs). Serrated Polyposis Syndrome (SPS) is a rare condition characterized by multiple polyps. Its genetic background and natural course have not been well characterized, though the risk of personal and familial colorectal cancer (CRC) is increased in SPS. SPS is a disease that is not well recognized, especially in Asian countries. The aim of this study was to evaluate the prevalence and clinicopathological characteristics of SPS in Japan.

Methods. We performed a retrospective study in 12 patients with SPS identified at Tokyo Metropolitan Komagome hospital, from the group that at least one serrated polyp was resected by endoscopic resection between July 2004 and January 2017. The following WHO criteria used to identify SPS: (1) at least five serrated polyps proximal to the sigmoid colon with two or more of them being > 10mm, (2) any number of serrated polyps proximal to the sigmoid colon in an individual who has a first degree relative with serrated polyposis, or (3) >20 serrated polyps of any size, but distributed throughout the colon.

Results. In total, 38,171 subjects underwent colonoscopies for screening at Tokyo Metropolitan Komagome hospital during the study period. Among them, 12 (0.03%) patients met the criteria for SPS. 6 were males and 6 were female. Their mean age was 61.2±12 (range 42-82) years. 12 met WHO criteria (1), and 4 met criteria (1) and (3). Average number of polyps was 17.9. 9 patients (75%) had CRC or high-grade dysplasia and 1 patient had pancreatic cancer at the initial presentation and during follow-up. 3 patients reported a family history of CRC in first-degree relatives.

Conclusion. SPS is a rare condition and the risk of personal and familial CRC is known to be increased in SPS. The prevalence of SPS in this study cohort was comparable to that in the Western population. Taking into account the high risk of CRC, correct diagnosis and careful follow-up for SPS are very important, and colonoscopy screening for the first-degree relatives of patients with SPS is needed to be examined.

PP152 - ENDOSCOPIC RISK FACTORS FOR DUODENAL CANCER IN FAMILIAL ADENOMATOUS POLYPOSIS (FAP)

C. A. Burke¹, S. S. Thiruvengadam², J. Barnholtz-Sloan³, L. LaGuardia¹, M. O'Malley¹, J. Church¹

¹Sanford R. Weiss MD Center for Hereditary Colorectal Neoplasia, Cleveland Clinic Cleveland, ²Cleveland Clinic Lerner College of Medicine, Cleveland Clinic Cleveland, ³Case Comprehensive Cancer Center, Case Western Reserve University Cleveland

Introduction: The frequency of EGD surveillance, lifetime risk of duodenal cancer (DC) and timing of prophylactic duodenectomy in FAP are based on Spigelman stage (SS, 0-IV) of duodenal polyposis. Guidelines suggest duodenectomy for patients with SSIV, and EGD surveillance for those with SS 0-III. In spite of EGD surveillance DC occurs. This study assesses endoscopic factors associated with DC in FAP. **Methods:** Demographic, clinical and endoscopic features in DC cases and controls were compared. Factors associated with DC were analyzed by logistic regression analysis. **Results:** 18 cases (8 ampullary (ADC) and 10 non-ampullary (NADC)) and 85 age matched controls were included. Mean age at DC was 47.9 years. No difference was noted in gender, race, age at FAP diagnosis, age of duodenal polyposis diagnosis or type or timing of colectomy. EGD surveillance duration was 5.9 years vs 13.3 years; $p < 0.001$ and fewer EGDs were performed (2 vs 7; $p < 0.001$) in cases than controls. Cases more likely had a history of SSIV (47% vs 15%; $p = 0.01$) than controls but 53% had no prior SS IV. Cases were less likely to have a history of >20 polyps (41.2% vs 71.8%, $p = 0.015$) and more often had duodenal polyps with HGD (29.4% vs 5.9%, $p = 0.003$) or a polyp >10 mm (76.5% vs 47.1%, $p = 0.027$). Advanced pathology of the papilla and a personal or family history of colon cancer were more frequent in DC cases. Cases less often had dysplastic fundic gland polyps and exposure to celecoxib ($p = 0.019$) or sulindac ($p = 0.016$). Patients with NADC more likely had SSIV polyposis (67% vs 15%; $p < 0.001$), a duodenal polyp with HGD (44.4% vs 5.9%, $p < 0.001$) and a polyp >10 mm (88.9% vs 47.1%, $p = 0.31$) than controls. Similar proportions of NADC and controls had >20 polyps or polyps with TVA/VA histology. Only 5/10 NADC cases had prior papilla biopsy. The papilla in these cases more often had TVA/VA histology (80% vs 22.4%, $p = 0.01$) and HGD (20% vs 3.5%, $p = 0.20$) versus controls. The frequency of SSIV was not different in ADC cases vs controls (25% vs 15%; $p = 0.48$). No component of SS differed between ADC cases vs controls. Histology of the papilla in ADC patients vs controls was more likely to demonstrate TVA/VA (80% vs 22.4%, $p = 0.01$) and HGD (40% vs 3.5% $p = 0.02$). **Conclusions:** SSIV was absent in a majority of FAP DC patients. Differential weighting of SS subcomponents and inclusion of papilla pathology may better estimate DC and NADC risk. SS does not appear helpful in determining ADC risk.

PP153 - CLINICAL AND MOLECULAR CHARACTERIZATION OF PATIENTS WITH COLORECTAL CANCER DIAGNOSED AT YOUNG AGES: EXPERIENCE OF A REFERENCE CANCER CENTER IN BRAZIL.

E. PALMERO¹, M. Carneiro², T. Silva¹, A. Coelho¹, C. Ramos¹, A. Escremim de Paula¹, R. M. Reis¹, J. C. Oliveira³, C. Scapulatempo-Neto⁴, B. M. Rossi⁵

¹Molecular Oncology research Center, Barretos Cancer Hospital, Brazil Barretos, ²Barretos School of Health Sciences, Dr. Paulo Prata "FACISB, Brazil. Barretos, ³Oncogenetics Department, Barretos Cancer Hospital, Brazil Barretos, ⁴Pathology Department, Barretos Cancer Hospital, Brazil Barretos, ⁵Oncogenetics Department, Hospital Sirio Liban, Brazil SÃo Paulo

Lynch syndrome (LS) is caused mainly by germline mutations in the mismatch repair genes. LS patients have an increased risk of developing colorectal cancer (CRC), as well as for extracolonic tumors. In addition to the presence of positive family history, tumor characteristics and young age at diagnosis are suggestive of LS. The aim of the study was to identify patients/families at-risk for LS through molecular characteristics and family history of cancer. For this, we included 219 patients diagnosed with CRC under the age of 50, treated at the Barretos Cancer Hospital (Brazil). From these, 208 patients were tested for the *BRAF* p.V600E mutation. The mean age at diagnosis was 41.2 years (19 to 50 years, SD = 7.2). Sixteen were positive for the p.V600E. None of them had a family history of Lynch-associated tumors. Among the 192 p.V600E-negatives (92.6%), the mean age was 41.1 years (vs. 41.7 of the p.V600E-mutated) and 8.3% had a positive first-degree family history for LS associated tumors. MSI analysis was performed for 200 patients: 155 patients were MSS (77.5%), 30 MSI-High (15.0%) and 15 MSI-Low (7.5%). MSS patients had a mean age at diagnosis of 42.1 years, versus 39.2 years for MSI-High and 43.5 years for MSI-Low patients (p=0.035). Among the MSI-High patients, 7 presented a family history suggestive of LS. Comparing *BRAF* and MSI results, we observed that the majority of *BRAF*-WT patients were MSS (75.4%). However, 30 MSI-High and 15 MSI-low were also identified. Among the *BRAF*-mutated cases, all were MSS (p=0.183). In addition, 134 tumors were analyzed for the *MLH1* methylation status. *MLH1* hypermethylation was found in six tumors. The mean age at the diagnosis was 41.8 among the unmethylated and 44.5 for the methylated patients (p=0.435). All methylated cases were *BRAF*-WT and 83.3% were MSI-High. Comparing the results of MSI, *BRAF* and methylation analysis, 20 patients with tumor characteristic of LS were observed. Those patients will be referred to the Oncogenetics service of the Institution for further investigation. Our results reinforce the importance of linking data from the personal and family history of cancer to the molecular data of the tumor, since a better characterization of these patients allows a better selection of patients with a real risk for LS, thus reducing expenses with costly genetic tests made unnecessarily, in addition to enabling identified patients to be directed to specific programs of treatment.

PP155 - THE INFLUENCE OF MUTATION CLASS ON THE SEVERITY OF LYNCH-RELATED CANCERS.

E. I. Palmero¹, N. Campacci¹, A. Escremin de Paula¹, P. Silva Felicio¹, R. M. Reis¹, H. Campos Reis Galvão²

¹Molecular Oncology research Center, Barretos Cancer Hospital, Brazil Barretos, ²Oncogenetics Department, Barretos Cancer Hospital, Brazil Barretos

Lynch Syndrome (LS) is an autosomal-dominant hereditary cancer syndrome that predispose individuals to developing colorectal cancer (CRC) and extracolonic tumors. It is caused by the presence of germline mutation in one of the DNA mismatch repair genes (MMR): *MLH1*, *MSH2*, *MSH6* and *PMS2*. There are two main classes of mutations: i) variants resulting in amino acid substitutions (missense mutations) and ii) alterations causing truncating proteins (nonsense and frameshift alterations) which determines the complete lack of protein synthesis or the expression of smaller variant. In fact, while the pathogenic role of the truncating mutations is clearly predictable, for patients with missense mutation, the molecular mechanism is more complex and still to be clarified. In this context, our aim was to compare families according to the type of mutation, to verify if truncating and missense mutations differentially affect the severity of Lynch-related cancers. We included 134 patients with germline mutations in the MMR genes from 45 families, identified at the Oncogenetics Department of Barretos Cancer Hospital, Brazil. Clinical significance of the mutations was revised using Clinvar, Insight and HGMD databases. Only class 4 and 5 mutations were included. Individuals carrying missense and truncating mutations were compared regarding to cancer diagnosis, type of cancer and age at cancer onset. Sixteen families (out of the 45 included) were *MSH2*-mutated, 15 (33.3%) *MLH1*-mutated, 10 (22.2%) with mutations in *MSH6* and 4 (8.9%) in *PMS2*. The great majority were truncating mutations (n=41, 91.1%). From all the individuals (134), 44.5% (n=59) had been diagnosed with cancer (67.8% with CRC and 32.2% with extracolonic cancers), with the mean age at diagnosis of 50 years old (SD:12; 95% CI:24-51). No statistically significant difference was found between mutation type and cancer type (p=0.54). Besides, cancer occurrence also did not have significant correlation with the presence of missense or truncate mutation (p=0.78). Logistic regression was performed to verify the risk to develop tumor, according to the mutation-type and the results were not statistically significant (p=0.69 (95% CI[0.415 – 3.714])). Lastly, age at cancer onset was compared between the groups carrying missense and truncating mutations, where no difference was observed. In conclusion, there is no difference in the risk of Lynch-related cancer development according to the class of mutations.

PP156 - CHARACTERISTICS OF PATIENTS WITH FAMILIAL ADENOMATOUS POLYPOSIS IN BRAZIL - FIRST RESULTS OF THE BARRETOS CANCER HOSPITAL REGISTRY.

E. I. Palmero¹, J. C. Oliveira², C. da Silva Sabato¹, H. Campos Reis Galvão², M. Neto², L. Romagnolo², D. Vilela Viana², R. M. Reis¹, B. M. Rossi³

¹Molecular Oncology research Center, Barretos Cancer Hospital, Brazil Barretos, ²Oncogenetics Department, Barretos Cancer Hospital, Brazil Barretos, ³Oncogenetics Department, Hospital S rio Liban s, Brazil S o Paulo

Familial Adenomatous Polyposis (FAP) is an autosomal dominant hereditary syndrome of colorectal cancer (CRC), caused by germline mutation in the tumor suppressor gene *APC*. FAP presents complete penetrance for colonic polyposis phenotype, with wide variation in their non-colic phenotypic expression. The identification of mutation sites is useful in the definition of high-risk patients for extra-colic events. The aim of our study was to correlate genotype-phenotype of Brazilian individuals carrying *APC* mutations and FAP. Between January 2012 and December 2013, 99 individuals from 35 families were evaluated, 50 female (50.5%) and 49 male (49.5%). The age ranged from 12 to 67 years with a mean of 30.7 and a median of 29 years. In the 35 families studied, we found 26 types of mutations in the *APC* gene. Fifty-five families harbored *nonsense* mutations (55.6%), *frameshift* alterations were seen in 39 cases (39.4%), aberrant splicing in 1 case (1%), rearrangements in 3 cases (3%) and the association between nonsense and rearrangement in 1 case (1%). When performing genotype-phenotype correlations we found classic FAP in 94 cases (94.9%) with predominance of mutations in exons 5, 8 and 15, and profuse in 5 cases (5.1%) with predominance of mutations in exons 7 and 15. Among the analyzed patients 63 (63.6%) were asymptomatic and 36 cases (36.4%) had been diagnosed with cancer. Among the patients with cancer and mutation at codon 986, we found 29 cases (80.6%) of CRC and 1 case (2.7%) of Central Nervous System (CNS). We also identified 4 cases (11.2%) of papillary thyroid cancer with mutation at codons 213 and 1062, and 2 cases (5.5%) of stomach cancer mutated in codon 986 e 1166. We found 9 individuals with desmoids tumor with mutations located at codons 213, 232, 302, 849, 1017, 1041 and 3 cases in codon 986. We found 10 individuals with osteoma, 3 cases mutated in codon 213 and 7 cases in codons 232, 283, 302, 554, 713, 1062 and 1309. We found 9 individuals with congenital hypertrophy of the retinal pigment epithelium (CHRPE) with 1 case in codon 232, 1 case in codon 805 and 7 cases in codon 1062. The genotype-phenotype correlation in Brazilian individuals with FAP showing specific findings not otherwise recorded demonstrate the relevance of further investigate the clinical and molecular profile of FAP patients in different populations, for adequate individual clinical management of patients harboring this medical condition.

PP157 - SOMATIC MLH1 MUTATION SCREENING IS SUPERIOR TO BRAFV600E MUTATION TESTING TO IDENTIFY SPORADIC MLH1-METHYLATED COLORECTAL CARCINOMAS

C. Rosty¹, M. Clendenning¹, A. Ko Win², F. Macrae³, I. Winship⁴, J. Hopper², D. English⁵, B. Daniel¹

¹Genetic Epidemiology Laboratory, University of Melbourne Centre for Cancer Research Melbourne, ²Centre for Epidemiology and Biostatistics, University of Melbourne Melbourne, ³Colorectal Medicine and Genetics, The Royal Melbourne Hospital Melbourne, ⁴The Royal Melbourne Hospital Melbourne, ⁵Cancer Epidemiology Centre, Cancer Council Victoria Melbourne

Introduction: Loss of immunohistochemical expression of MLH1 and PMS2 in colorectal carcinomas (CRC) can be caused by *MLH1* promoter methylation in sporadic tumours or by germline *MLH1* mutation in Lynch syndrome patients. Testing for *BRAF*^{V600E} mutation is currently the most common approach to stratify MLH1-deficient CRC into one of these groups, while *MLH1* methylation testing can be more difficult to interpret. *MLH1* somatic mutation screening is emerging as another approach to identify MLH1-deficient cases caused by biallelic mutations.

Materials and methods: Somatic *MLH1* mutation screening using Custom AmpliSeq panel and sequencing was performed on 55 MLH1-deficient CRCs previously characterised for *MLH1* methylation by MethyLight assay, *BRAF*^{V600E} mutation using a fluorescent allele-specific PCR assay and *MLH1* germline mutation by Sanger sequencing and Multiplex Ligation Dependent Probe Amplification (MLPA).

Results: There were 21 *MLH1*-methylated CRCs, 2 Lynch syndrome CRCs and 31 cases with no evidence of *MLH1* methylation and no *MLH1* germline mutation, referred to as Lynch-like syndrome cases. A *BRAF*^{V600E} mutation was identified in 16 cases, all of them demonstrating *MLH1* methylation. At least one somatic *MLH1* mutation was detected in 33/54 (61%) tumours tested, including the tumours from both Lynch syndrome patients. Absence of somatic mutation in *MLH1* was demonstrated in 20 of the 21 *MLH1*-methylated CRC. The positive predictive value of the absence of *MLH1* somatic mutation for identifying methylated cases was 0.95, while it was 0.76 for *BRAF*^{V600E} mutation. In addition, 12 of the 31 (39%) Lynch-like syndrome cases were identified to have biallelic *MLH1* somatic mutation.

Conclusions: Testing *MLH1*-deficient CRC for somatic *MLH1* mutation achieves better triaging of patients by excluding Lynch syndrome when no mutation or biallelic mutations are identified, compared with *BRAF*^{V600E} mutation testing.

PP158- HOW COST EFFECTIVE IS ENDOSCOPIC SUBMUCOSAL DISSECTION IN REMOVING LARGE COLORECTAL POLYPS? A COMPARISON WITH LAPAROSCOPIC COLECTOMY

M. Gamaleldin¹, C. Benlice¹, E. Gorgun²

¹Cleveland Clinic Colorectal Surgery Department Cleveland, ²Cleveland Clinic Colorectal Surgery Department Cleveland

Background: Colonoscopic polypectomy is the most cost effective way of controlling colorectal neoplasia.

However, some polyps are not suitable for conventional colonoscopic techniques. Previously such patients underwent colorectal resection but recently advanced endoscopic techniques such as combined endoscopic and laparoscopic surgery and endoscopic submucosal dissection (ESD) have been used. Because of the costs involved, the relative effectiveness of the options has been called into question. The aim of our study is to compare the outcomes of patients who underwent ESD with those of patients who underwent laparoscopic colectomy for benign colorectal polyps not amenable to conventional endoscopic removal.

Methods: Patients with an endoscopically benign colorectal polyp deemed inappropriate for conventional endoscopic removal and underwent ESD or colectomy between 2011 and 2016 were identified from an institutional review board approved prospectively maintained, cancer and outcomes database. Patients were case matched for age, gender, BMI, ASA, polyp size and location. Clinical outcomes and cost data were compared. Polyps at and proximal to the splenic flexure were deemed right-sided and polyps distal to the splenic flexure were deemed left-sided. Cost analysis included direct costs for the procedure and all procedure-related issues (hospital stay, complications).

Results: We identified 144 patients in the laparoscopic resection group (Group A) and 111 patients in the ESD group (Group B): 48 patients were matched (Table 1). All polyps were initially diagnosed as benign. Two patients in Group A had adenocarcinoma on final pathology. In Group B, 5 patients required surgical resection (10.4%). 2 had intraoperative full thickness defects, 1 had an intraoperative frozen section positive for adenocarcinoma, one was not amenable to ESD resection and one patient on follow up colonoscopy 9 months later was found to have serrated polyposis. Mean length of stay in Group A was 5.2 (± 2.4) days vs. 1.5 (± 1.4) in Group B ($p < 0.001$). Mean operative time for Group A was 136 minutes (± 45) vs. 132.9 (± 72.7) minutes for Group B ($p > 0.05$). In Group A, 6 patients had follow up colonoscopy within a year vs. 22 patients in Group B. In Group A 10/48 (21%) had complications vs. 7/48 (15%) in Group B ($p > 0.05$). Complications in Group A included small bowel obstruction (SBO), intrabdominal abscess and bleeding not requiring re-operation, while in group B, complications included a contained perforation managed conservatively, SBO, post procedural bleeding, and full thickness perforations managed intra-operatively. ESD had a 43% cost reduction advantage over laparoscopic colectomy with a 44% and 39% cost advantage for right and left sided lesions respectively.

Conclusions: ESD is more cost effective than conventional segmental resection, and can be offered as a colon preserving procedure.

Table 1: Matching Criteria			
	ESD (n = 48)	Laparoscopic (n = 48)	p
Age	65.44 (±9.52)	65.81 (±8.57)	0.840
Gender (n (%))			1.000
Male	27 (56.2%)	27 (56.2%)	
Female	21 (43.8%)	21 (43.8%)	
BMI	28.52 (5.13)	28.81 (5.29)	0.784
ASA			1.000
I	0 (0.0%)	0 (0.0%)	
II	15 (31.2%)	15 (31.2%)	
III	32 (66.7%)	32 (66.7%)	
IV	1 (2.1%)	1 (2.1%)	
Polyp Location			1.000
Right Colon	41 (85.4%)	41 (85.4%)	
Left Colon	7 (14.6%)	7 (14.6%)	
Polyp Size (cm)	2.78 (±0.91)	2.88 (±0.98)	0.606

PP159 - TREATMENT OF DESMOID DISEASE IN A 51-YEAR-OLD MALE WITH FAMILIAL ADENOMATOUS POLYPOSIS (FAP)

I. Danos¹, L. Lynagh¹, A. Spigelman¹

¹Cancer Genetics Unit, St Vincent's Hospital Sydney, Australia

Background: Desmoid tumours (DTs) are non-malignant locally invasive tumours which affect 15% of FAP patients. Their rarity and unpredictable growth pattern make treatment decisions difficult. Surgical resection has traditionally been the standard of care for DTs. Due to high recurrence rates following surgery as primary therapy, an individualized approach is recommended and may consist of active observation, radiation, chemotherapy, hormonal therapy, NSAIDs and surgery. We present a 51yo male with an FAP-related DT, where surgery was not suitable and two international expert opinions offered conflicting management advice.

Clinical history: A 50yo male with FAP developed a 9.5cm abdominal wall DT in July 2016.
Surgical history: colectomy and ileoanal pouch at 22yo, pancreas preserving duodenectomy for high grade dysplastic duodenal polyps at 47yo, complicated by gastroenterostomy leak, and pouch polyposis requiring ileoanal pouch excision and completion proctectomy with end ileostomy at 48yo.

Family history: The patient reports a family history of DT in his late niece whose cause of death was desmoid disease. Affected family members carry an *APC* deletion at codon 1478 (c.4434delAG), associated with a 6- to 12-fold increased risk for DTs.

Treatment options: DT deemed unresectable by hepato-pancreato-biliary surgeon due to involvement of anterior abdominal wall and left hemidiaphragm. Observation not suitable as DT progressing. Local sarcoma multidisciplinary team (MDT) recommended NSAIDs, followed by radiation if no regression of DT.

Two international experts were consulted and gave the following conflicting advice:

1. Avoidance of anatomically challenging surgery. NSAID (sulindac 150 mg or 200 mg bd) and high dose antiestrogen (raloxifene 120 mg od). Possible radiofrequency ablation. Cytotoxic chemo (doxorubicin and dacarbazine or vincristine/vinblastine and methotrexate) if DT rapidly growing.
2. Surgical resection with mesh reconstruction. Avoidance of NSAIDs as unlikely to cause regression. If opting for chemotherapy, preference for doxil.

As of January 2017 the patient is taking NSAID (meloxicam 30 mg od). Discussions are ongoing with local surgical colleagues and sarcoma MDT.

Discussion: A personalized treatment strategy is required for DTs. This abstract will serve to open a discussion on the best practice treatment of abdominal wall DTs from an international perspective.

PP160 - CLINICAL DIAGNOSTIC PMS2 TESTING IN A SINGLE COMMERCIAL LABORATORY: CHALLENGES IN GROSS DELETION/DUPLICATION ANALYSIS DUE TO PMS2CL INTERFERENCE

S. Palaniappan¹, C. Espenschied¹, J. Guiltinan¹, A. Yussuf², D. Salvador¹, C. Gau¹, B. Shirts²

¹Ambry Genetics Aliso Viejo, CA, ²Department of Laboratory Medicine, University of Washington Seattle, WA

Background: Lynch syndrome is the most common cause of hereditary colorectal cancer and is due to mutations in *MLH1*, *MSH2*, *MSH6* or *PMS2*. *PMS2* testing is complicated by the presence of pseudogenes. *PMS2CL*, one of the pseudogenes, has close homology to *PMS2* exons 11 to 15. When alterations are found in this region via NGS and/or MLPA, additional methodologies are necessary to determine if the alteration is in *PMS2* or *PMS2CL*. While special Sanger sequencing protocols can correctly identify the location for single nucleotide variants and small indels, available methodologies are sometimes unable to identify the location of gross rearrangements found in exons 11 to 15. To better understand the impact of *PMS2CL* interference, we analyzed *PMS2* results in a large cohort of patients undergoing testing for *PMS2* with targeted analysis of gross rearrangements found in exons 11 through 15.

Methods: Results of *PMS2* clinical testing via multi-gene panel testing (MGPT) or single syndrome testing from June 2010 through June 2016 at a single laboratory were analyzed.

Results: Of 88,155 patients who had *PMS2* testing via single syndrome testing or MGPT, 155 (0.17%) patients in our cohort had gross rearrangements in exons 1 to 11 and 335 (0.38%) in exons 11 to 15 of either the gene or pseudogene and required follow-up analysis. Using a combination of MLPA and Sanger sequencing as described in Vaugh et al 2011, we were able assign the gross rearrangement to either *PMS2* (0.12%, N= 102) or *PMS2CL* (0.19%%, N=169). The most common rearrangements in *PMS2* were EX11dup (N=19), EX11dup (partial) (N=12), EX14_EX15del (N=15) and Ex14del (N=15). The most common *PMS2CL* rearrangement was EX13CL_EX14CLdel (N=129). We were not able to determine the location of the gross rearrangement in 64 cases (0.07%) due to known limitations with the current methodology. Of these 64, 47 cases were Ex13_Ex14del. Efforts are currently underway to resolve these utilizing high coverage next generation sequencing, long range PCR, and targeted sequencing.

Conclusions: In our cohort, the majority of *PMS2* gross rearrangements were in exons 11-15. When a rearrangement was found in this region, we were able to determine the location of the rearrangement in 81% of cases. EX13CL_EX14CLdel appears to be a common *PMS2CL* deletion in our cohort and warrants additional study. Our results highlight the contribution of *PMS2* gross rearrangements to the diagnosis of Lynch syndrome and the need for further study of pseudogene interference and how to best address it.

PP161 - CLINICAL CHARACTERISTICS OF GASTRIC NEOPLASM IN PATIENTS WITH FAMILIAL ADENOMATOUS POLYPOSIIS.

R. Shimizuguchi¹, T. Yamaguchi², T. Tabata³, S. Shibata¹, T. Fujiwara¹, T. Onishi¹, T. Arakawa³, S. Horiguchi⁴, K. Koizumi¹
¹Tokyo Metropolitan Cancer and Infectious Diseases Center Komagome Hospital Gastroenterology Bunkyo-ku, Japan, ²Tokyo Metropolitan Cancer and Infectious Diseases Center Komagome Hospital Surgery Bunkyo-ku, Japan, ³Tokyo Metropolitan Cancer and Infectious Diseases Center Komagome Hospital Endoscopy Bunkyo-ku, Japan, ⁴Tokyo Metropolitan Cancer and Infectious Diseases Center Komagome Hospital Pathology Bunkyo-ku, Japan

~Objective~

Upper gastrointestinal neoplasms are frequently found in patients with familial adenomatous polyposis (FAP). Not only carcinogenesis occurred with *Helicobacter pylori* (*H. pylori*) infection but also that related with gastric adenoma or fundic gland polyposis (FGPs) have been reported. However, assessment of gastric neoplasms in patients with FAP has been well unknown. The aim of present study was to elucidate clinical characteristics of gastric neoplasms in patients with FAP.

Method~

Clinical records of 44 patients with FAP who underwent upper gastrointestinal endoscopy between 2004 and 2016 at Tokyo Metropolitan Cancer and Infectious Diseases Center Komagome Hospital were retrospectively reviewed. Clinical characteristics, such as endoscopic findings, *H. pylori* infection and pathological findings, were examined in 13 patients who had gastric neoplasm.

Results :

All 44 patients were Japanese, and 16 were male and 28 were female. Median age at the first time of upper gastrointestinal endoscopy was 36 years old (range 18-82 years). Of 44 patients, 31 patients (70%) having fundic gland polyposis (FGPs), and all of 31 patients were negative for *H. pylori* infection. Gastric adenomas were detected in 11 patients (25%) in antrum (n=5), gastric body (n=5), both antrum and gastric body (n=1). Six gastric adenomas were detected in antrum, and pathological findings were as follows; pyloric gland type (n=3), gastric foveolar type (n=1), fundic gland type (n=1), and intestinal type (n=1).

Eight early gastric cancers were detected in 5 of 44 patients (11%) at approximately 9 years from starting surveillance by gastrointestinal endoscopy, containing multiple gastric cancers occurred in 2 patients. Most of gastric cancers were detected in antrum or gastric body. We performed endoscopic submucosal dissection (ESD) for all gastric cancers, and all of these lesions were intramucosal well differentiated adenocarcinoma. Mean age at performing ESD was 52 years old (range 35-65 years), and mean diameter of lesions was 8mm (range 2-12 mm). Two patients had FGPs and three patients had gastric adenomas although *H. pylori* infection was positive in only 1 patient among patients with gastric cancer.

Conclusion :

The incidence of FGPs was reversely correlated with *H. pylori* infection in patients with FAP. The prevalence rates of gastric adenoma and cancer were 30% and 10%, respectively, almost patients with gastric cancer were negative for *H. pylori* infection. Carcinogenesis derived from gastric adenoma or FGPs other than *H. pylori* infection might relate to gastric neoplasm incidence in patients with FAP.

PP162 - SCREENING INDIVIDUALS AT INCREASED RISK FOR PANCREATIC CANCER USING BIENNIAL CONTRAST MRI

A. Borgida¹, S. Holter¹, C. Thomas², K. Jhaveri³, M. A. Haider³, S. Gallinger¹

¹Zane Cohen Centre for Digestive Diseases, Mount Sinai Hospital Toronto, ²University of British Columbia, Faculty of Medicine Vancouver, ³Medical Imaging, University Health Network Toronto

BACKGROUND

Pancreatic adenocarcinoma (PDAC) is the fourth leading cause of cancer deaths worldwide. The poor prognosis of PDAC is largely due to the majority of patients presenting with late-stage disease, which precludes the option of surgical resection, and generally ineffective chemotherapies. There are no uniform clinical screening guidelines for individuals at high risk of developing PDAC. The development of effective screening techniques may improve overall survival in a high risk cohort.

METHODS

Individuals were identified through the Ontario Pancreas Cancer Study registry at Mount Sinai Hospital. Those who met the following criteria were enrolled in a 5-year prospective PDAC screening study from 2011 to 2016.

BRCA2 Mutation Carriers

- At least one relative with PDAC
- ≥ 50 years of age or 10 years younger than the age of the youngest relative with PDAC

Familial Pancreas Cancer (FPC) Relatives

- At least two blood relatives with PDAC
- First or second degree relative of an affected family member
- ≥ 50 years of age or 10 years younger than the age of the youngest relative with PDAC

Participants had biannual contrast MRIs at the Princess Margaret Cancer Centre in Toronto and were asked to provide a blood sample for future genetic and biomarker studies.

RESULTS

60 high-risk individuals from 44 families (24 male, 36 female) with an average age of 60 years (range 32-87) were consented for the study. There were 50 participants from FPC families and 9 participants had a BRCA2 mutation. One participant with a p16 mutation was included despite not meeting eligibility criteria. Thirteen individuals withdrew over the 5-year study. The mean number of MRIs for all participants was 7.3. No cases of PDAC were identified over the study. Seventeen participants had radiologic evidence of intraductal papillary mucinous neoplasms (IPMNs) that remained stable throughout the study. Twenty participants had stable pancreatic cysts. Two p16 mutation carriers enrolled in our prior screening study, but excluded from the current study, developed advanced and fatal PDAC over the past 5 years.

CONCLUSION

Screening of apparent high risk germline BRCA2 carriers and individuals from FPC kindreds was ineffective in preventing PDAC. Selection of high risk subjects for PDAC screening remains problematic. Based on recent reports of others, we are developing a new protocol using EUS and contrast-MRI for a cohort of p16 and PRSS1 carriers, and 1st-degree FPC relatives with a significant family history of PDAC.

PP165 - NOVEL DUPLICATION OF SCG5/GREM1 AS A CAUSE FOR HEREDITARY MIXED POLYPOSIS SYNDROME (HMPS)

L. Lynagh¹, I. Danos¹, S. Dooley², R. Scott², D. Williams³, A. Spigelman¹

¹Cancer Genetics Unit, St Vincent's Hospital Sydney, Australia, ²Molecular Medicine, Pathology North Newcastle, Australia,

³Department of Gastroenterology, St Vincent's Hospital Sydney, Australia

Background: HMPS is an autosomal dominant condition causing the development of polyps of multiple and mixed morphologies including Peutz-Jeghers polyps, juvenile polyps, conventional adenomas and colorectal cancer. A 40kb duplication including the 3' region of SCG5 and the upstream region of GREM1 has been demonstrated as the disease causing mutation in families with Ashkenazi ancestry. A different 16kb duplication in the same region was detected as a cause of HMPS in a Swedish family without Ashkenazi ancestry. Both duplications resulted in an increase in expression of GREM1 in colonocytes compared to controls. Tumorigenesis is caused by increased GREM1 ectopic expression, which is predicted to decrease BMP pathway activity.

Proband: A 35 year old female with UK ancestry presented for surveillance colonoscopy due to a family history of colorectal cancer (CRC). Colonoscopy identified a 15mm semi-pedunculated tubulovillous adenoma in the ascending colon and multiple sessile serrated polyps in the hepatic flexure, transverse colon, descending colon and rectosigmoid. Two sessile serrated polyps as well as the adenoma were biopsied and confirmed histologically. Both the tubulovillous adenoma (15mm) and sessile serrated adenoma (10mm) had intact MMR expression on IHC.

Family history: Father diagnosed with metastatic colon cancer age 42. Sister diagnosed with melanoma age 37 and with a 1.2mm rectal cancer (within a polyp) age 38 with around 20 serrated polyps throughout the colon. The rectal cancer was detected at surveillance colonoscopy subsequent to HMPS diagnosis in the proband. She opted for a laparoscopic anterior resection which showed no metastatic disease. Paternal family history was unknown as the family had lost contact.

Genetic testing: MUTYH genetic testing by MLPA revealed a duplication encompassing exons 5 and 6 of SCG5 extending beyond exon 2 of GREM1.

Discussion: This case demonstrates a novel duplication in the 15q13.3 region with different breakpoints to previously described duplications. Predictive genetic testing is ongoing in this family with no results available yet. Surveillance colonoscopy every 6 months has been initiated in the proband in the first instance. Functional analysis to determine the level of expression of GREM1 in colorectal tissue of the proband would be a useful test to confirm the mechanism of disease.

PP168 - THE INSIGHT DATABASE –“ TRANSFORMATION FOR THE GENOMICS ERA

J. P. Plazzer¹, M. Genuardi², E. Holinski-Feder³, F. Macrae¹

¹Colorectal Medicine and Genetics, The Royal Melbourne Hospital Melbourne, ²Institute of Genomic Medicine, *â€œA. Gemelli* Faculty of Medicine, Catholic University of the Sacred Heart Rome, ³Medizinische Klinik und Poliklinik IV, Campus Innenstadt, Klinikum der UniversitÃ¤t MÃ¼nchen Munich

On behalf of the InSiGHT Variant Interpretation Committee.

The InSiGHT database is a free public curated database that collates data for Mismatch Repair (curator: John Paul Plazzer), APC (curators: Stefan Aretz, Kirsten Wöllner and Isabel Spier), STK11 (curators: Radha Perera and Julian Daniell), MUTYH (curator: Carli Tops), POLE and POLD1 (curators: Daniel Buchanan and Ian Tomlinson), and SMAD4 and BMPR1A (curator: Karl Heinemann). The database is visited by approximately 2000 unique users per month, attracting upwards of 40,000 page views.

Previously, the InSiGHT database was based on LOVD version 2 software. However, the advent of genomic sequencing technologies has required that it be upgraded to version 3. This new database is available at www.insight-database.org.

Methods: The data in LOVD2 format required processing (a combination of manual and automated procedures) for all variants. For certain types of data, manual conversion into LOVD3 data types was performed. For example, new records for phenotype data were created from existing disease information. 31 disease codes were created from existing free text disease descriptions. Genomic data was also generated for all existing coding variants.

Results: For Mismatch repair (MMR) genes, the database now holds 15284 variant entries covering an estimated 3373 unique variants. Of these, 6241 are missense variant entries (990 unique missense variants). The InSiGHT Variant Interpretation Committee (VIC) has classified 200 unique missense variants as clinically actionable (Class 1,2,4 or 5). The other 790 are of uncertain significance. The VIC continues to meet regularly to address problematic variants. The new LOVD3 will streamline curation and interpretation of variants. Genomic co-ordinates will allow integration with genomic analysis software and enable importing of either exome/genome or panel data.

Conclusion: The InSiGHT MMR variant database continues to service the needs of diagnostic laboratories with the most authoritative interpretation of MMR variants. Submissions of variant and associated clinical data are always needed to enrich the database and ensure its leading position in variant interpretation. Discussions continue with a wide range of laboratories and DNA repositories. The VIC is the official (ClinGen) expert panel responsible for interpreting MMR variants for ClinVar, with whom it shares outcomes. Interested InSiGHT members are welcome to join the VIC.

Enquiries are welcome through john-paul.plazzer@mh.org.au

PP172 - CHARACTERISATION OF MISMATCH REPAIR VARIANTS SUBMITTED TO THE INTERNATIONAL MISMATCH REPAIR CONSORTIUM (IMRC)

J. C. Reece¹, D. D. Buchanan², J. P. Plazzer³, A. K. Win¹, G. Lee¹, A. Templeton⁴, R. W. Haile⁵, G. Moslein⁶, F. Macrae³, M. A. Jenkins¹
¹Centre for Epidemiology and Biostatistics, Melbourne School of Population and Global Health, The University of Melbourne Carlton,
²Colorectal Oncogenomics Group, Genetic Epidemiology Laboratory, Department of Pathology, The University of Melbourne,
Parkville Parkville, ³Department of Medicine, The University of Melbourne Parkville, ⁴Fred Hutchinson Cancer Research Center
Seattle, ⁵School of Medicine, Division of Oncology, Stanford University Stanford, ⁶Helios St. Josefs-Hospital Bochum-Linden Bonn

Background: The International Mismatch Repair Consortium (IMRC) is a worldwide collaborative Lynch syndrome study requesting researchers and clinicians to submit pedigree data on families with a pathogenic mutation in a mismatch repair (MMR) gene. Pedigree data has been received for 6,054 families (118,916 individuals) from 53 consortia representing 23 countries. Data include description of the MMR gene mutated, and for each family member, mutation status, age, sex, and cancer diagnoses. Detailed MMR variant characterisation has the potential to refine estimates of penetrance by the type of mutation, and thereby improve clinical management for Lynch families. The large data source of the IMRC could also provide additional variants to the InSiGHT MMR LOVD database. It is critical variant descriptions are standardised to LOVD nomenclature and are confirmed as pathogenic. Prevalence estimates of variants are also of interest. As such, we aimed to collate and classify MMR gene variants submitted to the IMRC.

Method: Submitted variants were formatted to LOVD nomenclature using Mutalyzer software and checked for overlap with the InSiGHT MMR database. Variant pathogenicity was assigned based on InSiGHT variant classification criteria and cancer frequencies compared by variant type (missense vs protein truncating). Variant prevalence was estimated by determining frequency in a genome Aggregation Database (gnomAD) with 126,000 exome and 15,000 whole-genome sequences of controls.

Results: 1681 unique MMR variants were submitted to the IMRC for 6,054 Lynch families.

Gene	<i>MLH1</i>	<i>MSH2</i>	<i>MSH6</i>	<i>PMS2</i>	<i>EPCAM</i>	Total
Families	2,086	2,556	894	472	46	6,054
No. MMR variants	572	642	325	125	16	1,681

Specific variants were reported for as few as 1 family and for as many as 187 families from 11 countries across Europe, Asia, Australia, South and North America (*MSH2*; c.942+3A>T). Variant descriptions were diverse and necessitated variant-by-variant curation. A comparison of IMRC variants with InSiGHT MMR variants is identifying substantial overlap, however, some variants submitted to the IMRC variants are new. IMRC variants are also represented in the genome Aggregation Database, gnomAD. While the majority of IMRC variants are classified as pathogenic, a proportion of IMRC variants are classified as uncertain pathogenicity or non pathogenic. Analyses in collaboration with the InSiGHT Variant Interpretation Committee are ongoing.

Conclusion: The large-scale endeavour of the IMRC is increasing the understanding of the range and frequency of MMR gene variants and will ultimately improve the clinical management of families with Lynch syndrome.

Funding source: Australian National Health and Medical Research Council (NHMRC)

PP174 - UNRAVELING THE SERRATED NEOPLASIA PATHWAY: IMMUNOHISTOCHEMISTRY AND NEXT-GENERATION SEQUENCING REVEAL UNIQUE FEATURES OF MLH1-PROFICIENT EARLY DYSPLASTIC SESSILE SERRATED LESIONS

A. Bleijenberg¹, J. IJspeert¹, R. Reinten², S. van Eeden², E. Dekker¹, C. van Noesel²

¹of Gastroenterology and Hepatology, Academic Medical Centre Amsterdam, ²Pathology, Academic Medical Centre Amsterdam

Background: Colorectal cancer (CRC) in Serrated Polyposis Syndrome (SPS) often develops through the serrated neoplasia pathway. The (epi)genetic alterations involved in this pathway are only marginally understood. We aimed to evaluate which pathways are associated with early progression of Sessile Serrated Lesions (SSL), and to compare features of MLH1 deficient and MLH1 proficient SSL with a focus of dysplasia or cancer.

Methods: All SSL with a focus of dysplasia or cancer of < 10 mm, diagnosed from 2006 onwards in the Academic Medical Centre were centrally revised. Eligible lesions were included for analysis. Sections were immunostained for β -catenin, p53, SMAD4 and MLH1. DNA was extracted from the non-progressed and the progressed components of lesions and examined for CpG Island methylator phenotype (CIMP) status, microsatellite instability (MSI) and the presence of mutations within a panel of 23 genes by next generation sequencing. The sequenced reads were used to assess the degree of single nucleotide variation within MSI and microsatellite stable (MSS) lesions respectively.

Results: 35 SSL with a focus of dysplasia or cancer were included. Progressed components more often showed loss of MLH1 (60% vs 0%; $p < 0.001$), evidence of WNT pathway activation (17% vs 0%; $p = 0.04$), TP53 dysfunction (29% vs 0%; $p < 0.01$) and TGF- β pathway dysfunction (23% vs 0%), as compared to non-progressed components. A BRAF mutation (present in 97% of both components) and CIMP-high phenotype (86% vs 71%; $p = 0.06$) were equally often found in both components. Loss of MLH1 within the progressed component was associated with female gender (90% vs 57%; $p = 0.02$), diagnosis at older age (median 68 vs 58 years; $p < 0.01$) and MSI (100% vs 0%; $p < 0.001$), while inversely associated with WNT pathway activation (5% vs 36%; $p = 0.02$) and TGF- β pathway dysfunction (10% vs 43%; $p = 0.02$) (Figure 1). MSI and MSS lesions demonstrated a similar degree of single nucleotide variations ($p = 0.51$), while a non-significant trend was seen for MSI carcinomas, as compared to MSI dysplasia (Figure 2).

Conclusion: The clinical and molecular profiles of SSL with early progression critically depend on the MLH1 expression status. As compared to MLH1 deficient lesions, proficient lesions are more often driven by WNT activation or impairment of the TGF- β pathway and more often found in male patients of younger age. MSI can be found even in the smallest lesions with loss of MLH1 expression, but only seems to result in the initiation of a hypermutated profile in SSL that have progressed to cancer.

Lesion	1	2	3	4	5	6	7	8	9	10	11	12	13	14	15	16	17	18	19	20	21	22	23	24	25	26	27	28	29	30	31	32	33	34	35	
MLH1 proficient	no	no	no	no	no	no	no	no	no	no	no	no	no	no	no	no	no	no	no	no	no	yes	yes	yes	yes	yes	yes	yes	yes	yes	yes	yes	yes	yes	yes	
Microsatellite stable	no	no	no	no	no	no	no	no	no	no	no	no	no	no	no	no	no	no	no	no	no	yes	yes	yes	yes	yes	yes	yes	yes	yes	yes	yes	yes	yes	yes	yes
Activated WNT pathway	no	no	no	no	no	no	yes	no	no	no	no	no	no	no	no	no	no	no	no	no	no	yes	no	no	no	no	no	no	no	no	no	no	no	no	no	no
Dysfunctional TGF-β pathway	no	yes	no	no	no	no	no	no	no	no	no	no	no	no	yes	no	no	no	no	no	no	no	no	no	no	yes	yes	yes	yes	yes	yes	yes	yes	yes	yes	yes
Dysfunctional TP53 pathway	yes	yes	no	no	no	no	no	no	yes	no	no	no	no	no	no	no	yes	no	no	no	no	no	no	no	no	no	no	no	no	no	no	no	no	no	no	no
CIMP-low/CIMP-neg	no	no	no	no	no	no	no	no	no	no	no	no	no	no	no	no	no	no	no	no	no	yes	yes	yes	yes	yes	yes	yes	yes	yes	yes	yes	yes	yes	yes	yes
Male gender	no	no	no	no	no	no	no	no	no	yes	no	no	no	no	no	yes	no	no	no	no	no	no	yes	yes	yes	yes	yes	yes	yes	yes	yes	yes	yes	yes	yes	yes

yes
 no

Figure 1. Clinical and molecular characteristics of progressed sessile serrated lesions stratified by MLH1 expression.

Immunohistochemically, lesions 1-21 showed no MLH1 expression and lesions 22-35 showed MLH1 expression.

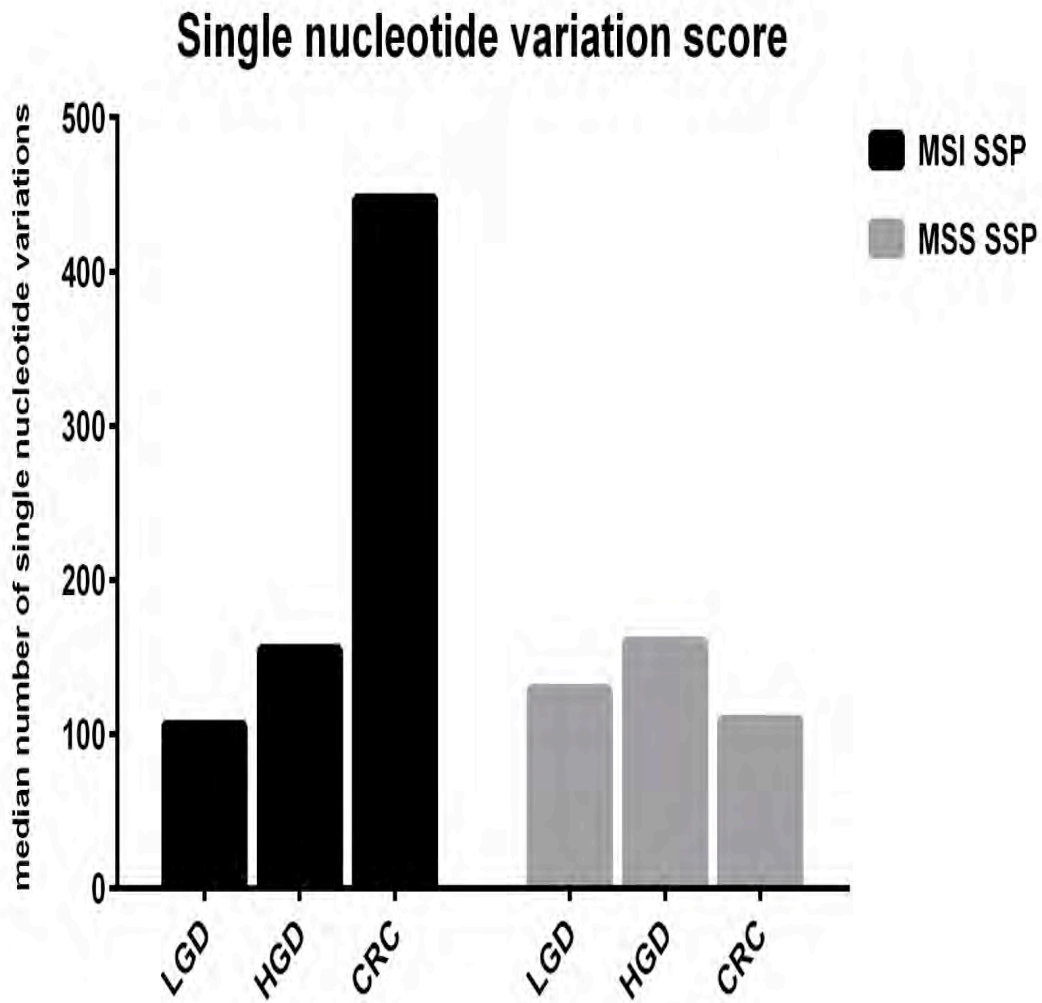

Figure 2. Median number of clonal and subclonal (threshold $\geq 1\%$ of cells) single nucleotide variations in sessile serrated lesions with low-grade dysplasia, high-grade dysplasia and cancer, as detected with Ion AmpliSeq™ Colon and Lung Cancer Research Panel. Data were stratified for the presence of microsatellite instability

PP175 - CDH1 PROMOTER REGION AS COFACTOR FOR A DIFFUSE GC OCCURRING AT YOUNG AGE.

V. De Re¹, L. Caggiari¹, M. De Zorzi¹, R. Magris², S. Maiero², M. Fornasari², R. Cannizzaro²

¹Bio-Proteomics Facility Aviano, ²Oncological Gastroenterology Aviano

Hereditary gastric cancer (HDGC) is an inherited form of diffuse gastric cancer (GC) a highly invasive tumor characterized by late presentation and poor prognosis. Germline pathogenetic mutation of the CDH1 gene codifying for the E-cadherin protein (Ecad) was found in only 25-50% of HDGC and mutation of a single allele is not sufficient for the reduction of E-cad.

The aim of this study is to investigate the contribution of polymorphisms of promoter-5'UTR region (c.-396 to c.1) of CDH1 in GC risk assessment.

We tested 193 GC at diagnosis, median 63 years: 59,2% diffuse, 35,2% intestinal and 5,6% of mixed histotype. Genomic DNA was isolated from peripheral blood and CDH1 variants detected by using PCR followed by direct sequencing. Active H. Pylori infection (HP) was determined by histologic examination.

We found 6 variants: -160C>A in the promoter (n=104) and -54C>G (n=1), -71G>C (n=5), -176T>C(n=2), -276T>C (n=2), -197A>C (n=1) in the 5'UTR. The first 3 variants were known to lead a reduction of the E-cad *in vitro*, but their impact *in vivo* is still to be defined. MAF -160 A (rs16260) in homozygous (n=21, 10.9%) was present in GC only without HP-infection. Within the GC HP⁺, the -160 CC genotype was more frequent in the intestinal type (3/9, 33.3%, vs 2/11, 18.2%). Genotype -160 A/A confer a reduction of E-cad activity to 68% by methylation. Aberrant CDH1 methylation was also reported in HP⁺ GC. Combining the presence of MAF -160 A in homozygous and -54C>G or -71G>C, both proposed to reduce the production of E-cad by affecting the transcription binding site, we found a case (-160 A/A + -71G>C) without pathogenetic germline CDH1 mutation: as woman with a diffuse GC at the angulus occurring at a 39 years old, T3N+ stage, no active HP-infection.

Our data evidence the potential contribution in E-cad reduction through methylation of the CDH1 promoter region due to the presence of MAF -160 A mutation or alternatively to an active HP infection. Accordingly to this finding, we found that pepsinogen 2 level correlated with the HP⁺ infection status and was lowest in patients having the -160 A/A genotype (mean 9,2 vs 12,2). There is, so far, not enough evidence to indicate that MAF -160 A or other mutation in the 5'UTR region have an impact on E-cad expression *in vivo*. Our study highlighted potential contribution of these germline mutations, especially if present in contemporary as cofactors favoring a down regulation of the E-cad and thus a familiar GC susceptibility.

PP176 - A NOVEL MUTATIONAL SIGNATURE CHARACTERIZES COLORECTAL CANCER IN PATIENTS WITH MUTYH-ASSOCIATED POLYPOSIS

A. Viel¹, A. Bruselles², E. Meccia³, M. Fornasarig⁴, M. Quaia¹, V. Canzonieri⁵, E. Policicchio⁶, E. D. Urso⁷, M. Agostini⁷, M. Genuardi⁸, E. Lucci-Cordisco⁸, T. Venesio⁹, A. Martayan¹⁰, M. G. Diodoro¹⁰, L. Sanchez-Mete¹⁰, V. Stigliano¹⁰, F. Mazzei³, F. Grasso³, A. Giuliani³, M. Baiocchi², R. Maestro¹, G. Giannini¹¹, M. Tartaglia⁶, L. B. Alexandrov¹², M. Bignami³

¹Functional Onco-Genomics and Genetics, CRO Aviano National Cancer Institute, Aviano, Italy, ²Department of Haematology, Oncology and Molecular Medicine, Rome, Italy, ³Department of Environment and Primary Prevention, Istituto Superiore di Sanit , Rome, Italy, ⁴Unit of Gastroenterology, CRO Aviano National Cancer Institute, Aviano, Italy, ⁵Unit of Pathology, CRO Aviano National Cancer Institute, Aviano, Italy, ⁶Genetics and Rare Diseases Research Division, Ospedale Pediatrico Bambino Gesù¹, Rome, Italy, ⁷First Surgical Clinic, Department of Surgical, Oncological and Gastroenterological Sciences, University of Padua, Padua, Italy, ⁸Institute of Genomic Medicine, Catholic University, Rome, Italy, ⁹Unit of Pathology, Candiolo Cancer Institute-FPO, IRCCS, Candiolo, Turin, Italy, ¹⁰Division of Gastroenterology and Digestive Endoscopy, Regina Elena National Cancer Institute, Rome, Italy, ¹¹Department of Molecular Medicine, University La Sapienza, Rome, Italy, ¹²Theoretical Biology and Biophysics and Center for Nonlinear Studies, Los Alamos National Laboratory, Los Alamos, New Mexico, USA

Biallelic *MUTYH* mutations are associated with colorectal cancer (CRC) in the *MUTYH*-Associated Polyposis (MAP) syndrome. When operating normally, the *MUTYH* DNA glycosylase prevents 8-oxoG-related mutagenesis by excising the incorporated adenine. Conversely, in the presence of *MUTYH* inactivating mutations, 8-oxoG generates G:C>T:A transversions *via* mispairing with adenine during DNA replication.

With the double aim of investigating whether persistent 8-oxodG:A mismatches lead to a specific mutational fingerprint and which genes are involved in colorectal oncogenesis associated with inactive *MUTYH*, we performed whole-exome DNA sequencing in 7 tumour and matched non-tumour colonic tissues from 6 unrelated MAP patients. As expected, a moderate (1.5-fold) increase in mutation rate and an excess of somatic G:C>T:A transversions was found in comparison to colorectal cancer stem cell lines and sporadic CRCs.

To identify the mutational signature associated with persistent 8-oxoG:A mispairs, we performed a refined classification of base substitutions to include the 3' and 5' flanking bases at the mutated site and highlighted a novel mutational signature, termed Signature 36, with a strong sequence dependence.

Recurrently mutated genes in the 7 MAP CRCs were identified and included *APC*, *KRAS*, *PIK3CA*, *FAT4*, *TP53*, *FAT1*, *AMER1*, *KDM6A*, *SMAD4* and *SMAD2*. Targeted gene sequencing of 10 additional CRCs and 26 adenomas from a new set of MAP patients confirmed the MAP-related mutagenic profiles of these 10 genes. *AMER1* and *APC* were equally mutated in adenomas and CRCs confirming their role as driver genes in MAP. In contrast *SMAD2*, *SMAD4* and *TP53* were rarely mutated in adenomas, suggesting they are predominantly involved in the late events of MAP colorectal carcinogenesis.

In conclusion, alterations in MAP CRCs affect the well-established *WNT*, *TGF *, *PI3K*, *RAS* and *p53* signalling pathways, but the mutational profiles also reveal the specificity of MAP oncogenesis, with limited features in common with MMR-proficient and -deficient CRC.

PP177 - COMPARISON OF LONG-TERM SURVIVAL BETWEEN TOTAL COLECTOMY WITH ILEO-RECTAL ANASTOMOSIS (IRA) AND PROCTOCOLECTOMY WITH ILEO-POUCH ANAL ANASTOMOSIS (IPAA) IN PATIENTS WITH FAMILIAL ADENOMATOUS POLYPOSIS (FAP): WITHIN AN OLD QUESTION. A REGISTRY-BASED,

I. Ardoino¹, S. Signoroni², M. Vitellaro³, E. Malvicini⁴, M. T. Ricci², E. M. Biganzoli⁵, S. Occhionorelli⁴, L. Bertario²

¹Unit of Medical Statistics, Biometry and Bioinformatics - Fondazione IRCCS Istituto Nazionale dei Tumori Milan, Italy, ²Hereditary Digestive Tract Tumors Unit, Dep. of Preventive and Predictive Medicine - Fondazione IRCCS Istituto Nazionale dei Tumori Milan, Italy, ³Colorectal Surgery Unit, Dep. of Surgery; Hereditary Digestive Tract Tumors Unit, Dep. of Preventive and Predictive Medicine - Fondazione IRCCS Istituto Nazionale dei Tumori Milan, Italy, ⁴Department of Morphology, Surgery and Experimental Medicine, University of Ferrara and S. Anna University Hospital of Ferrara Ferrara, Italy, ⁵Unit of Medical Statistics, Biometry and Bioinformatics - Fondazione IRCCS Istituto Nazionale dei Tumori; Department of Clinical Sciences and Community Health, University of Milan Milan, Italy

Background

The surgical choice for patients with Familial Adenomatous Polyposis (FAP) is still debated. No prospective trial has been carried out to evaluate pros and cons of the recommended procedures: total colectomy (IRA) vs. restorative proctocolectomy (IPAA). The aim of the study was to support a precision and tailored surgery in patients with FAP.

Methods

A retrospective review of patients with FAP undergone surgery and registered in the Hereditary Colorectal Tumour Registry, at Fondazione IRCCS Istituto Nazionale dei Tumori of Milan, was conducted. Twenty years survival according to surgical approach and main prognostic factors was investigated with Cox regression model. Propensity score was also run to perform comparison.

Results

A total of 925 patients underwent surgery between 1947 and 2015: 340 (36.8%) IPAA and 585 (63.2%) IRA. Colorectal cancer (CRC) at surgery was diagnosed in 28.6% of patients and *APC* pathogenic variant was identified in 88% of patients. During a median follow-up of 129 months, 150 patients died. Survival probability was significantly higher in the IRA group than in the IPAA: 0.82 vs. 0.75 (HR=0.6, 95%CI: 0.42-0.84). In multivariable regression model and by adjusting for propensity score, a similar difference was still observed although no longer significant. The multivariable analysis indicated as independent risk factors CRC (HR=4.68, 95%CI: 3.04-7.20) and age at surgery (HR=1.03, 95%CI: 1.02-1.06). Among patients without cancer, the main risk factor for survival was age (HR=1.06, 95%CI: 1.04-1.09).

Conclusion

The study shows higher long-term survival in IRA than in IPAA, although not significant, suggesting an individually and clinically tailored surgical choice, better at an early age.

PP178 - INITIAL RESULTS OF MULTIGENE PANEL TESTING FOR HEREDITARY COLORECTAL CANCER

R. Piva¹, G. Casalis Cavalchini², C. Bracco², F. D'Alessio², C. Boin², E. Pellegrino³, G. Benetton², B. Pasini⁴

¹Medical Genetics Unit, AOU Città della Salute e della Scienza Torino, Italy, ²Medical Genetics Unit, AOU Città della Salute e della Scienza Torino, ³Department of Molecular Biotechnology and Health Sciences, University of Torino Torino, ⁴Medical Genetics Unit, AOU Città della Salute e della Scienza, Department of Medical Sciences, University of Turin Torino

BACKGROUND: Approximately 5% to 6% of colorectal cancer (CRC) cases are associated with germline mutations that confer an inherited predisposition to cancer. Screening for hereditary cancer syndromes in patients with CRC includes review of personal and family histories, and testing of tumors for DNA mismatch repair deficiency. Genetic evaluation is recommended for individuals who meet defined criteria in order to offer proper follow-up strategies and personalized therapies. The advancement of next-generation sequencing (NGS) technologies to the clinic is transforming the diagnostic procedures with significant impact on the management of patients with CRC.

METHODS: A series of 63 probands with clinical suspicion for Lynch syndrome (39 cases), with adenomatous polyposis (17 cases), juvenile polyposis syndrome (1 case), hereditary diffuse gastric cancer (3 case), or Li-Fraumeni syndrome (3 cases) were investigated. Coding exons and flanking intronic sequences (+/- 50 bp) of twenty-five genes associated with increased risk for colorectal and gastrointestinal cancers were analyzed by a next-generation sequencing custom panel including *APC*, *AXIN2*, *BMPRIA*, *CDH1*, *CHEK2*, *CTNNA1*, *ENG*, *EPCAM*, *GALNT12*, *MLH1*, *MSH2*, *MSH6*, *MUTYH*, *NTHL1*, *PMS2*, *POLD1*, *POLD3*, *POLE*, *POLE2*, *PTEN*, *RPS20*, *SEMA4A*, *SMAD4*, *STK11*, and *TP53*. Deletion/duplication analysis of selected genes (*APC*, *CDH1*, *EPCAM*, *MLH1*, *MSH2*, *MSH6*, *PMS2*, and *TP53*) was performed by MLPA. Pathogenic and likely pathogenic mutations were confirmed by Sanger sequencing. DNA mismatch repair (MMR) deficiency was evaluated by MSI testing and IHC analyses.

RESULTS: Predicted target coverage of the panel was 99.62%. Paired-end reads 2x150-bp were generated at a median coverage of 750-fold. Approximately 95.0% of targeted bases had a minimum of 20 reads. Missing regions were enriched for genes with known pseudogenes such as *PMS2*, *CHEK2*, *BMPRIA*, and *PTEN*. An average of 2 rare coding or splice junction variants per patient were detected. Pathogenic or likely pathogenic mutations were found in 39% of patients. These were highly concordant with the clinical suspicion and the MMR status. The NGS panel failed to detect copy number variations in *MLH1* and *MSH6*, which were identified by MLPA.

CONCLUSIONS: The NGS approach is cost-effective and significantly reduces diagnostic turnaround times for syndromes that frequently display overlapping clinical features, such as Lynch and polyposis. An implementation of the panel to adequately cover all target regions and detect large copy number variants is in progress.

PP180 - USE OF TECHNOLOGY AND SOCIAL MEDIA TO FACILITATE FAMILY COMMUNICATION IN LYNCH SYNDROME

S. Peterson¹, A. Burton-Chase², J. McLaughlin³, R. Yzquierdo¹, C. Galvan¹, M. Askins¹

¹MD Anderson Cancer Center Houston, Texas, USA, ²Albany College of Pharmacy and Health Sciences Albany, New York, USA,

³Radiant Creative Group LLC Houston, Texas, USA

Disseminating information about a Lynch syndrome (LS) pathogenic gene mutation within affected families depends largely on the willingness and ability of relatives to share results of genetic testing. Communication of LS-related information (e.g., genetic test results, cancer risk management information, psychosocial support for LS) occurs most frequently between an informed, tested family member and his/her first-degree-relatives. Conversely, communication is less likely with more distant relatives; barriers include family estrangement, disruption, or lack of perceived need for LS-related information. We evaluated communication patterns and methods, and health information sources, used by LS-affected persons to share LS-related information with close (first-degree) and distant (second-degree or greater) relatives. LS mutation carriers (n=52), with or without a cancer diagnosis, were recruited through a cancer center's clinical genetics program and through social media (i.e., Twitter, Facebook) for qualitative phone interviews. Transcripts were coded using Atlas.ti; intercoder reliability exceeded 90%. Co-occurrence (CO) frequencies were computed between communication methods and patterns regarding close vs. distant relatives. Consistent with prior studies, participants reported closed or little communication with distant relatives (0.16 CO). Participants reported they would be willing to share LS-related information with relatives with whom they have had a prior conflict (0.25 CO). LS-related information was conveyed to first-degree relatives largely through verbal communication (0.17 CO). However, E-mail, social media, and other electronic means were primarily used to communicate with more distant relatives (0.04-0.08 CO). Participants reported relying on other relatives as intermediaries for communication of LS-related information in the case of family estrangement or conflict; in these cases, social media and other electronic communication methods were often used to convey information about LS. Encouraging communication about LS and genetic risk among more distant relatives within a family remains a challenge. Utilizing technology-based communication strategies may facilitate more complete dissemination of genetic risk information within LS families.

PP182 - DIAGNOSTIC YIELD OF A COMPREHENSIVE GENE PANEL FOR HEREDITARY TUMOR SYNDROMES

I. Spier¹, J. Henn², R. Adam³, K. Kayser², S. Peters², S. Uhlhaas², S. Holzapfel¹, G. Plotz⁴, S. Aretz¹

¹Institute of Human Genetics and Center for Hereditary Tumor Syndromes, University of Bonn, Bonn, Germany, ²Institute of Human Genetics, University of Bonn, Bonn, Germany, ³Institute of Human Genetics, University of Bonn, Bonn, Germany; Center for Experimental and Molecular Medicine, Academic Medical Center Amsterdam, Amsterdam, The Netherlands, ⁴Medizinische Klinik 1, Biomedical Research Laboratory, University of Frankfurt, Frankfurt, Germany

Background: In a considerable number of patients with a suspected hereditary tumour syndrome (HTS), no underlying germline mutation can be identified in the genes that are most likely affected. We established and validated an extensive gene panel to analyse the yield and clinical utility of a more comprehensive diagnostic approach.

Methods: The Illumina TruSight™ Cancer Sequencing Panel of 94 known genes for HTS was extended by further 54 genes. For technical validation, 64 HTS patients with a broad spectrum of known germline mutations were included. In addition, 173 patients with suspected HTS were analysed, where no germline mutation had been identified in the most likely affected genes. This cohort consisted of cases with multiple primary tumours, young age at onset and/or a striking familial clustering of various tumours.

Results: The sensitivity to identify known germline base pair substitutions and small insertions/deletions was 100%. In addition to the known mutations, 195 rare, potentially pathogenic variants in 85 genes were identified. The proportion of rare variants was similar in both patient groups: 31% in patients with known mutation (comprising 27% of patients) and 69% in patients with unexplained disease (comprising 73% of patients). The proportion of variants in the moderate penetrant genes *CHEK2* and *ATM* was not significantly higher in patients with unexplained disease. After further filtering, we found potential causative mutations in 25% of patients with known mutation (seven truncating mutations, nine missense variants and one stoploss mutation). The most interesting finding was a *NF1* nonsense mutation in a case with a known *TP53* frameshift mutation. In 17% of patients with unexplained disease, we identified 20 truncating mutations, one start loss and 15 missense variants. In three of these patients (2%) the mutations are very likely to be causative (*PMS2*, *PTEN*, and *POLD1* genes). In both patient groups, presumptive predictive information could be revealed (truncating mutations in *SDHA*, *EXT1* and *RAD51C*).

Conclusions: We demonstrate that the application of a comprehensive gene panel can identify the etiology in some prescreened patients with unexplained disease and provide predictive incidental findings. However, our findings also show that some patients harbour predicted pathogenic mutations in more than one established cancer gene which makes the interpretation of the phenotypic contribution of those alterations even more challenging.

PP183 - RISK ASSESSMENT AND SURVEILLANCE OF GASTROINTESTINAL CANCER IN PATIENTS WITH LI-FRAUMENI SYNDROME

K. Tamura¹, S. Kim¹, S. Kido², J. Tatsumi¹, N. Tomita³

¹Kindai University Higashiosaka, ²Kindai University Osakasayama, ³Hyogo College of Medicine Nishinomiya

[Purpose] Li-Fraumeni syndrome (LFS) has a predisposition to multiple primary malignant tumors caused by abnormalities of *TP53* gene in childhood or young adults, and is a genetic disorder with autosomal dominant manner. To improve precaution against cancer by performing early treatment be able to be expected. In clinical genetics, definitive diagnoses of the affective individuals may give at-risk relatives to significant impact including psychosocial issues such as anxiety and fear to the future. Therefore, we should provide genetic information carefully. In this way, LFS patients are required to survey over a lifetime, and mutant allele carriers in the family is the same. We considered based on the LFS 11 families carried out genetic testing.

[Subjects & Method] We have collected clinical and pathological data and examined 66 tumors from 40 cases in 11 families, which have been detected *TP53* mutations. Then, we have been considering the surveillance program.

[Results & Discussion] In ages 0-14 years, brain tumors, soft tissue tumors, bone sarcomas, and in the 30s, breast cancer, lung cancer, etc. has frequently developed. On the other hand, since the 40s, gastrointestinal cancer such as gastric cancer and colorectal cancer has developed frequently. Li - Fraumeni syndrome is recognized as childhood cancer, and the medical staffs is likely to attract attention to childhood surveillance. Therefore, it is recommended that patients with Li-Fraumeni syndrome or at-risk relatives receive the intensive gastrointestinal screening after age 40.

Furthermore, we examined what function is consistent with the age-dependent curve of the onset of Li-Fraumeni syndrome. Consequently, cancers in childhood were consistent with the logarithmic function, and the adult-onset cancers proved to be most compatible with the Gompertz function. Li-Fraumeni syndrome cancers of childhood were suggested that cancer cells are generated in prenatal or soon after birth. It is important to identification of *TP53* mutant carriers using presymptomatic genetic testing and carrying out appropriate surveillance based on the characteristics of the age-dependent of the onset of Li-Fraumeni syndrome tumors.

PP185 - HIGH PREVALENCE OF BENIGN AND MALIGNANT THYROID DISEASE IN PATIENTS MIT FAMILIAL ADENOMATOUS POLYPOSIS (FAP)

R. HÃ¼neburg¹, P. van Heteren¹, S. Aretz², H. Ahmadzadehfahr³, C. P. Strassburg¹, J. Nattermann¹, D. Pantelis⁴

¹Department of Internal Medicine I, Center for hereditary tumor syndromes, University Hospital Bonn Bonn, Germany, ²Institute for Human Genetics, Center for hereditary tumor syndromes, University Hospital Bonn Bonn, Germany, ³Department of Nuclear Medicine, University Hospital Bonn Bonn, Germany, ⁴Department of Surgery, Center for hereditary tumor syndromes, University Hospital Bonn Bonn, Germany

Background and study aims: Patients with FAP are at a high risk to develop colorectal cancer and other gastrointestinal malignancies. In retrospective series, an increased prevalence (0.4-2%) of thyroid cancer has been reported in these patients, whereas only little data is available regarding benign thyroid disease. Here, we studied the prevalence of pathological findings in FAP patients.

Material and Methods: Thyroid examination, consisting of palpation, ultrasound, and blood analysis (TSH, fT3 and autoantibodies), was offered to 67 FAP patients as part of their surveillance protocol. **Results:** 57/67 patients (85%) agreed to undergo thyroid examination (33 women, 24 men; average age: 34 years (15-66 years)), and thus were included in our study. An APC mutation was known in 54/57 patients, the remaining patients had not been tested. Papillary thyroid cancer was found in 3/57 (5%) patients, including two women (aged 19 and 28 years, respectively) and one man (23 years). Goiter was observed in 13 patients (23%), and autoimmune thyreoditis was diagnosed in six patients (10.5%).

Conclusion: Patients with FAP are at a high risk for benign or malignant thyroid disease independent of gender, which underscores the importance of regular thyroid examination in these patients.

PP186 - ENDOSCOPIC SURVEILLANCE OF THE UPPER GASTROINTESTINAL TRACT IN LYNCH SYNDROME PATIENTS

R. HÄneburg¹, P. van Heteren¹, D. Pantelis², S. Aretz³, C. P. Strassburg¹, J. Nattermann¹

¹Department of Internal Medicine I, Center for hereditary tumor syndromes, University Hospital Bonn Bonn, Germany, ²Department of Surgery, Center for hereditary tumor syndromes, University Hospital Bonn Bonn, Germany, ³Institute for Human Genetics, Center for hereditary tumor syndromes, University Hospital Bonn Bonn, Germany

Introduction:

Besides increased risk for the development of colorectal cancer Lynch syndrome is also associated with an increased life-time risk for the development of gastric (up to 8%) and small bowel cancer (up to 12%), respectively. However, the diagnostic performance of esophagogastroduodenoscopy in surveillance of Lynch syndrome patients remains unclear and, thus, has been analyzed in the present study.

Material und Methods:

Between 01/2006 and 12/2016 Lynch syndrome patients with a proven germline mutation in a mismatch repair gene were examined by esophagogastroduodenoscopy. Results: A total of 175 examinations in 84 patients (42 female/42 male) with proven germline mutation (31 MLH1 (37%), 41 MSH2 (49%) and 12 MSH6 (14%)) were performed. Patient mean age was 48 years (+/-12 years). During endoscopic examination two gastric adenomas (2.4%) and one gastric cancer were found (1.2%). In one patient duodenal cancer as well as two adenomas were found. In addition, a duodenum-infiltrating pancreatic cancer was detected in one patient. Inflammation was apparent in 92 examinations (53%), intestinal metaplasia in 23 examinations (13%), and Barrett esophagus including one high-grade dysplasia in 14 examinations (9%). Finally, 12 patients (14%) were found to display a helicobacter pylori infection.

Conclusion:

Endoscopic surveillance of the upper gastrointestinal tract revealed pathologic findings in a relevant proportion of Lynch syndrome patients. Further prospective studies are needed.

PP187 - MOLECULAR CHARACTERIZATION OF A FAMILY WITH AN UNUSUAL POLYPOSIS PHENOTYPE CAUSED BY A NOVEL POLE MUTATION

E. Castellsagué¹, R. Li², R. Aligüé³, S. González¹, A. Velasco⁴, J. Sanz¹, J. Brunet⁴, W. Foulkes⁵

¹Hereditary Cancer Program, Catalan Institute of Oncology, IDIBELL and CIBERONC Barcelona, ²McGill University and Genome Québec Innovation Centre, McGill Montreal, ³Departament de Biomedicina Facultat de Medicina Universitat de Barcelona, IDIBAPS Barcelona, ⁴Hereditary Cancer Program, Catalan Institute of Oncology, IDIBGI and CIBERONC Barcelona, ⁵Department of Human Genetics, McGill University Montreal

Over the past years, several studies have shown that germline mutations in the proofreading domains of *POLE* and *POLD1* DNA polymerases predispose to multiple intestinal polyposis and CRC. Although predominantly associated with the colon, other tumor sites have been reported to be affected, including carcinomas of the breast, stomach and ovary, and brain tumors among others. At the somatic level, due to the disruption of the proper proofreading activity, these tumors acquire an exceptional number of mutations, known as an ultramutated phenotype. This ultramutated phenotype also presents in sporadic tumors with somatic *POLE* mutations, mainly colorectal and endometrial but also from the brain, pancreas, ovary, breast and stomach amongst others.

Here, we describe a family, with a distinct phenotype of familial polyposis with four siblings affected by multiple or classic polyposis with or without CRC, one of them presenting with CRC and tumors of the ovary and the breast.

In order to elucidate the genetic cause of cancer aggregation in this family we performed whole-exome sequencing (WES) on the germline of the four affected siblings as well as on the somatic FFPE DNA of the CRC from the individual with multiple tumors. A novel mutation in the exonuclease domain of *POLE* (c.2850G>T; p.K950N) was found at the germline of all affected siblings and the colorectal tumor, which carried a second *POLE* mutation (c. 833C>A; p.T278K) outside the proofreading domain. Both mutations are predicted to be pathogenic and are located in highly conserved protein residues of the protein.

Several approaches helped us to conclude that T278K is the cause of the disease in the family: i) a non-affected sibling appeared to not carry the mutation, suggesting a highly penetrant inheritance pattern; ii) functional studies in yeast showed an increased mutation rate of the T278K compared to the wild-type protein; and iii) the WES data of the FFPE colorectal DNA showed an ultramutated phenotype, with a higher C>A at TpCpT context and C>T at TpCpG context, which is in accordance with *POLE* somatic mutations signatures. Finally, we will better characterize the somatic mutational signature of this family by performing WES on all available tumors.

Overall, our case report will contribute to the better understanding of the recently described polymerase proofreading-associated polyposis (PPAP), both at the mechanistic and the phenotypic levels of the disease.

PP188 - PANEL TESTING FOR HEREDITARY COLORECTAL CANCER

E. Lucci-Cordisco¹, R. Pietrobono¹, M. G. Pomponi², M. Calicchia¹, L. Remondini¹, M. Genuardi³

¹Institute of Genomics Medicine-Catholic University Rome, ²UOC Medical Genetics-A.Gemelli Foundation University Hospital Rome,

³Institute of Genomics Medicine, Catholic University-UOC Medical Genetics, A.Gemelli Foundation University Hospital Rome

Hereditary colorectal cancer is a genetically heterogeneous condition. In some cases the personal or family history are strongly suggestive of a specific hereditary syndrome (e.g. the association of gastrointestinal polyposis and mucocutaneous pigmentation in patients with Peutz-Jeghers syndrome). In many cases, however, the patient's personal or family history may raise suspicion for several hereditary conditions (e.g. AAP, MAP and PPAP). A step-wise approach to genetic testing in these patients can be costly and time consuming. On the contrary, next-generation sequencing make it possible to test for multiple genes simultaneously (panel-based testing). Although this approach may detect pathogenic variants, is also expected to increase the number of variants of uncertain significance (VUS).

The aims of our study were to estimate the rates of pathogenic variants (PV) and VUS identified through panel-based testing for hereditary CRC and to verify whether patients with a PV met genetic testing criteria for the cancer syndromes identified.

So far, we analyzed genomic DNA from 45 patients: 15 with colorectal adenomatous polyposis (AP), 2 with colorectal hamartomatous polyposis (HP), 11 with suspected Lynch syndrome (LS), 10 with multiple cancers (MC), and 7 with early-onset colorectal cancer (EO-CRC). The analysis was conducted on Ion Torrent PGM with a home-made 13-gene panel (*MUTYH*, *MSH2*, *MSH6*, *MLH1*, *APC*, *BMPRIA*, *PTEN*, *POLE*, *CDHI*, *TP53*, *SMAD4*, *STK11*, *POLD1*) Sequencing data of the targeted genes were analyzed with Torrent Suite (Life Technologies). Additional Sanger sequencing was performed for any regions with insufficient coverage depth (<20) by NGS and for regions containing putative variants. Alterations were classified based on guidelines established by InSiGHT and the ACMG/AMP into the following categories: (1) pathogenic mutation; (2) variant, likely pathogenic; (3) variant, unknown significance; (4) variant, likely benign; (5) benign.

Among 45 patients tested, 5 (11%) had PVs or probably PVs: 2 were in LS patients, 2 in EO-CRC and 1 in AP. Nine probands had VUSs. Patients with PVs or VUSs had clinical histories suggestive of the condition related to the gene harbouring the detected variants.

In conclusion, we show the importance of using multigene panels that allow for a parallel comprehensive screening for CRC syndromes.

¹<http://insight-group.org/>

²Richards S et al. Genet Med. 2015 May;17(5):405-24

PP189 - WORLDWIDE STUDY OF CANCER RISKS FOR LYNCH SYNDROME: INTERNATIONAL MISMATCH REPAIR CONSORTIUM (IMRC)

M. Jenkins¹, J. Reece¹, G. Lee¹, R. Haile², G. Moslein³, F. Macrae⁴, W. Aung¹

¹Centre for Epidemiology and Biostatistics, The University of Melbourne Melbourne, ²Stanford University Stanford, ³Helios St. Josefs-Hospital Bochum-Linden Bochum-Linden, ⁴Department of Medicine, Melbourne Health Melbourne

Aims: To bridge critical gaps in Lynch syndrome research, the International Mismatch Repair Consortium (IMRC) was formed in 2010 (in collaboration with InSight and CGA) and comprises major worldwide consortia involved in research and/or clinical treatment of Lynch syndrome <http://www.sphinx.org.au/imrc>. Currently, the IMRC has 268 members from 123 centres/clinics throughout Asia, Africa, Australasia, Europe, and North and South America. IMRC membership is open to anyone involved in Lynch syndrome research or clinical care.

Cancer risk may differ not only by age, gender and the mutated gene but also by the genetic variant, country, and ethnicity of the carrier. The only way to thoroughly address this potential heterogeneity is to conduct comprehensive penetrance analyses on large, ethnically heterogeneous samples of families segregating mutations in MMR genes.

Method: The IMRC will: (i) establish a combined data set of pedigree data from around the world for approximately 8,800 Lynch syndrome families; (ii) estimate the age-specific cumulative risk (penetrance) of cancers at each anatomical site by sex, mismatch repair gene, type of mutation, and nationality/geographic region; and (iii) develop a personal risk tool for clinical use that provides 10-year risks of cancer based on the age, sex, mismatch repair gene, type of mutation, and nationality/geographic region.

Results: Since July 2014, IMRC investigators from 123 sites have been contacted and requested to submit the MMR family data from their clinics/centres. Instructions on the data format were provided, including data dictionaries for personal and family history of demographic data, cancers, MMR gene mutation status, screening, surgery and mortality. As of January 2017, 43 investigators representing 53 different sites in 23 countries have submitted MMR pedigree data for 6054 Lynch families including 15,700 mutation carriers.

Gene	<i>MLH1</i>	<i>MSH2</i>	<i>MSH6</i>	<i>PMS2</i>	<i>EPCAM</i>	Total
Families	2086	2556	894	472	46	6054
Carriers	5421	6692	2438	1001	148	15700

Based on communication with other investigators, we anticipate submission of approximately 3,400 families by June 2017, bringing the total to 9,400 families.

Conclusion: Collection of Lynch syndrome family data from many international sites has progressed well despite the challenges faced by sites to establish databases for epidemiological research with varying resources. Thorough checking of submitted data to the IMRC is currently underway prior to penetrance analysis.

PP190 - FROM PHENOTYPE TO GENOTYPE: AN ATYPICAL LYNCH SYNDROME

D. Barana¹, Z. Baretta¹, M. Padovani¹, M. C. Pegoraro¹, M. Magaz¹, S. Cottini¹, A. Scarpa², M. Montagna³, A. Vie⁴, C. Oliani¹
¹Oncology Unit, ULSS8 Berica Arzignano (VI), ²Pathology Department, AOUI Verona, ³Oncologic Molecular Laboratory IOV Padova, ⁴Oncogenetics ed Oncogenomics Functional Unit, CRO Aviano (PN)

Introduction:

Recent publications describes families with “Atypical” phenotype of Lynch Syndrome. Uncommon clinical manifestations include Ovarian Cancer (OC) and Breast Cancer (BC). We present a family with atypical phenotype of Lynch syndrome.

Case report:

In May 2014, a 42 years old woman with a diagnosis of BC at 36 years presented to our Genetic Clinic to be tested for BRCA 1/2 genes mutations. In the family history, her mother had received a diagnosis of serous OC and rectal adenoma at 51 years, urothelial cancer at 52 years, and bladder cancer at 55 years. Patient's BRCAPRO was 23%. Taking into account the patient's family history and the BRCAPRO >10%, the patient was tested for BRCA 1/2 genes mutations. Genetic test showed no pathogenic mutations nor other variants of BRCA genes. Therefore, taking into consideration the cancer history of the patient's mother, we also evaluated the microsatellite status of rectal adenoma of the patient's mother which resulted microsatellite instable. Expression of MLH1, MSH2 and MSH6 was shown normal by immune-histochemistry. Then, we tested the patient's mother for the presence of mutations in mismatch repair genes (MLH1, MSH2, MSH6). The Multiplex Ligation Probe Amplification (MLPA) test revealed the MSH2 c.1511-?_1661+?dup variant, which is a large duplication in exon 10 (nucleotides 1511-1661) of the MSH2 gene. This variant was not present in the currently used mutation databases. However, a functional test on mRNA showed the r.1511_1661dup and predicted truncated protein p.Ser554Argfs*9.

Successively, we searched for the presence of this genetic alteration in our proband (woman with BC and BRCA test negative) and her siblings. The patient and one of her two sisters resulted negative while her brother and the other sister resulted positive.

Conclusion:

BRCA-related predisposition and Lynch syndrome share OC as one of the clinical manifestations. In families with OC cases, genetic test for mismatch repair genes mutations should be performed, when BRCA test is negative.

PP192 - SYSTEMATIC SCREENING FOR LYNCH SYNDROME IN A COHORT OF COLORECTAL AND ENDOMETRIAL CANCER PATIENTS IN SWITZERLAND: THE SYSSYL STUDY.

A. AYME¹, S. ARCIONI², V. MEMBREZ³, J. FEILCHENFELDT⁴, L. FONTENEAU⁵, V. VIASSOLO⁵, S. MYIT⁶, M. GENEVAY⁷, G. PUPPA⁷, L. RUBBIA-BRANDT⁷, P. HUTTER⁸, P. O. CHAPPUIS⁹

¹Division of Clinical Pathology - Unit of Oncogenetics and Cancer Prevention, Division of Oncology, Geneva University Hospitals Geneva, Switzerland, ²Division of Medical Genetics, Institut Central des Hôpitaux Sion, Switzerland, ³Division of Medical Genetics, Institut Central des Hôpitaux - Division of Oncology, Hôpital du Valais Sion, Switzerland, ⁴Division of Oncology, Hôpital du Valais Sion, Switzerland, ⁵Unit of Oncogenetics and Cancer Prevention, Division of Oncology, Geneva University Hospitals Geneva, Switzerland, ⁶Division of Histocytopathology, Institut Central des Hôpitaux Sion, Switzerland, ⁷Division of Clinical Pathology, Geneva University Hospitals Geneva, Switzerland, ⁸Division of Medical Genetics, Institut Central des Hôpitaux - Laboratory of Molecular Oncology, Geneva University Hospitals Sion - Geneva, Switzerland, ⁹Unit of Oncogenetics and Cancer Prevention, Division of Oncology, Geneva University Hospitals - Division of Medical Genetics, Institut Central des Hôpitaux - Division of Genetic Medicine, Geneva University Hospitals Geneva - Sion, Switzerland

Introduction: Despite international criteria and guidelines, Lynch syndrome (LS) remains largely under-diagnosed. Loss of expression of mismatch repair (MMR) proteins and microsatellite instability (MSI) are hallmarks of LS. We aimed to implement and test a strategy based on a systematic pre-screening of colorectal cancer (CRC) and endometrial cancer (EC) diagnosed in the resident population in 2 regions of Switzerland to identify carriers of germ-line mutations in MMR genes.

Methods: Between 05.2009 and 05.2014, all patients living in the Geneva and Valais cantons diagnosed with invasive CRC or EC before the age of 76 were eligible. After collection of sociodemographic and pathological data, as well as family history and a signed consent form, a pre-screening procedure was performed using immunohistochemistry (IHC) staining for MLH1, MSH2, MSH6, PMS2 proteins and MSI testing with 3 monomorphic microsatellites (BAT25, BAT26, CAT25). In case of positive pre-screening and after exclusion of *BRAF* c.1799T>A (V600E) mutation, genetic counselling with germ-line mutations testing in MMR genes was proposed.

Results: Among 518 patients referred for the study, 39 (7.6%) were not eligible, 36 (7%) could not be contacted and 37 (7.2%) refused to participate. Finally, 406 patients were eligible: 337 CRC and 69 EC cases. Both pre-screening procedures were feasible for 397 (97.8%) samples. Concordance between IHC staining and MSI testing results was observed in 393/397 (99%) cases. Pre-screening result was positive in 49/403 (12.2%) cases. Among these patients, 6 carried the *BRAF* c.1799T>A (V600E) mutation, 3 rapidly died after diagnosis, 2 refused to proceed and 38 had genetic counselling: 31 (81.6%) patients agreed to perform genetic testing and 8 pathogenic variants in MMR genes (*MLH1*: 5, *MSH2*: 2, *PMS2*: 1) were identified. Thus, 8/406 (2%) cases in this cohort were related to LS, all of them younger than age 66, and 5/8 of these situations do not fulfil any of the criteria or guidelines proposed to identify LS.

Conclusion: Amsterdam criteria and Bethesda guidelines display insufficient performance to identify LS in unselected CRC or EC patients. Systematic pre-screening using IHC staining for MMR proteins and/or MSI testing was more efficient to identify LS, particularly in CRC and EC patients affected before the age of 66. In this study, a certain number of patients refused to participate to the pre-screening procedure or to genetic testing.

PP194 - A NOVEL RISK SNP IN THE CRC RISK LOCUS ON CHROMOSOME 9Q22

J. Thutkawkorapin¹, H. Mahdessian¹, S. Picelli¹, S. von Holst¹, J. Lunding¹, V. Kontham¹, T. Liu¹, D. Nilsson¹, X. Jiao¹, A. Lindblom¹
¹Department of Molecular Medicine and Surgery, Karolinska Institute Stockholm

Background:

Heritable factors are well known to increase the risk of cancer in families. Our linkage analysis in 2006 suggested a region on chromosome 9q22. to be linked to an increased risk of adenomas and cancer in one large study and the same region was also published by others. A few years later we performed another linkage study in familial colorectal cancer and again could replicate the region on chromosome 9q22.

Aims:

We set up to identify the genetic mutation within this locus.

Methods:

We used a combination of exome sequencing, targeted sequencing and association study. The cases are Swedish familial and consecutive colorectal cancer samples. 500 genotypes in the 9q region were selected from an ongoing GWAS in Swedish CRC to search for a founder effect in the 9q.

Results:

In the exome sequencing study, there was no mutations suggested to be disease causing in the coding region. In the association study using 2709 colorectal cancer cases and 4782 controls, one SNP, rs6477733, suggested a risk with odds ratio 1.53 and p-value 0.000192 (n.s.).

PP196 - CLASSIFICATION OF A NOVEL MLH1 VARIANT THROUGH FUNCTIONAL ANALYSIS, CONFIRMING A NOVEL SPLICE-SITE MUTATION MECHANISM

D. Georgiou¹, B. Desouza¹, S. Payne², L. Busby², C. Brookes², M. Ramos², D. Ashiani², C. Cummings¹

¹North West Thames Regional Genetics Service London, ²North West Thames Regional Genetics Laboratory London

Lynch syndrome is the most commonly inherited colorectal cancer syndrome. It is caused by inactivating germline mutations in DNA mismatch repair (MMR) genes: *MLH1*, *MSH2* (including *EPCAM*-deletion mediated *MSH2* hypermethylation), *MSH6*, and *PMS2*. Since the discovery of these genes, segregation analysis, functional analysis and in silico prediction have helped to determine the pathogenicity of novel variants.

We present a case study involving the characterisation of a novel pathogenic *MLH1* variant. Our patient developed a Duke's B adenocarcinoma (caecal) at the age of 48 in the absence of a family history of cancer. Immunohistochemistry studies revealed loss of MLH1 and PMS2 expression. Tumour DNA showed no BRAF V600E mutation and no *MLH1* promoter methylation. Sequencing of *MLH1* revealed a variant of unknown significance in intron 1: c.117-3C>G. There was no published data on this variant and it was classified as a variant of uncertain significance. However, in-silico analysis suggested that the variant may affect splicing and RNA analysis was undertaken to investigate this further. This showed that the *MLH1* variant gives rise to aberrant splicing of exon 2 of *MLH1*. This change results in the creation of a frameshift mutation, r.117_121delTTTAG, p.(Cys39Ter). This unusual mechanism has only been described once before in the literature, in a family with c.117-2A>T in *MLH1*. Given our patient's cDNA showed a complete heterozygous state, we reclassified the variant as pathogenic and predictive genetic testing has been offered to the family. The *MLH1* variant has been submitted to the InSiGHT database.

Our findings demonstrate the clinical utility of in silico prediction and functional analysis in determining the pathogenicity of variants of uncertain significance in the MMR genes. This would further benefit families through the implementation of cancer surveillance and risk reducing interventions.

PP197 - PHENOTYPE IN A MALE INDIVIDUAL CARRYING BOTH MLH1 AND EPCAM GERM-LINE PATHOGENIC VARIANTS

M. Met-Domestici¹, V. Viassolo¹, A. Ayme², A. Murphy¹, M. Genevay³, P. Hutter⁴, P. Chappuis⁵

¹Unit of Oncogenetics and Cancer Prevention, Division of Oncology, Geneva University Hospitals Geneva, ²Division of Clinical Pathology, Geneva University Hospitals; Unit of Oncogenetics and Cancer Prevention, Division of Oncology, Geneva University Hospitals Geneva, ³Division of Clinical Pathology, Geneva University Hospitals Geneva, ⁴Division of Medical Genetics, Institut Central des Hôpitaux; Laboratory of Molecular Oncology, University Hospitals of Geneva Geneva, ⁵Unit of Oncogenetics and Cancer Prevention, Division of Oncology, Geneva University Hospitals; Division of Medical Genetics, Institut Central des Hôpitaux; Division of Genetic Medicine, Geneva University Hospitals Geneva

Introduction: Inherited defects in more than one colorectal cancer (CRC) susceptibility genes have been reported in several combinations, e.g. germ-line variants in one of the mismatch repair (MMR) genes and concomitant variants in *APC* or *MUTYH*. Concerning MMR genes only, very few cases of carriers of variants of uncertain significance (VUS) in combination with pathogenic variants or another VUS in different MMR genes have been reported. Here, we describe the first case of double heterozygosity for *MLH1* and *EPCAM* pathogenic variants identified in a male individual.

Case description: We met a 43-year-old man diagnosed at the age of 38 with right colon adenocarcinoma, surgically resected. No Lynch syndrome pre-screening had been done on tumoral sample at the time of diagnosis. He presented a strong cancer family history on the paternal side fulfilling the Amsterdam criteria: his brother had CRC at the age of 31 and his father, two metachronous CRC at 48 and 67, as well as ureteral cancer at the age of 57. The patient's father was found to be carrying a *MLH1* pathogenic variant (c.2093C>G/p.Ser698*). Consequently, we offered our proband a targeted molecular screening that showed the presence of the paternal *MLH1* variant and recommended a clinical surveillance adjusted to his genetic status.

Over the years, we met several relatives for predictive testing and we have been able to edit family history. We were informed that a fourth-degree relative on the maternal side of our proband was carrying an *EPCAM* deletion (c.491-509_*13721del) affecting MSH2 expression. On this side of the family, Bethesda guidelines were met since the index case had been diagnosed with CRC in his thirties and one of his second-degree relatives with gallbladder cancer. We offered our proband a second targeted germ-line analysis and identified the maternal *EPCAM* deletion. Thus, this patient happened to be double heterozygous for pathogenic variants in *MLH1* and *EPCAM*. Retrospective testing on his CRC sample showed a MSI-high phenotype and loss of MSH2/MSH6 immunostaining with normal MLH1 and PMS2 expression. During the 10 years follow-up, this patient did not develop any other malignancy.

Conclusion: Like double heterozygosity for variants in *BRCA1* and *BRCA2*, being a carrier of germ-line pathogenic variants in two distinct MMR genes does not seem to result in a more severe phenotype or a significantly earlier-onset diagnosis in comparison with individuals with monoallelic mutations.

PP199 - ELUCIDATING THE CLINICAL SIGNIFICANCE OF TWO PMS2 MISSENSE VARIANTS COEXISTING IN A FAMILY FULFILLING HEREDITARY CANCER CRITERIA

M. González-Acosta¹, J. del Valle¹, M. Navarro¹, B. A. Thompson², S. Iglesias¹, X. Sanjuan³, M. J. Pauls³, N. Padilla⁴, A. Fernández¹, R. Cuesta¹, Á. Teulé¹, G. Plotz⁵, J. Cadiñanos⁶, X. de la Cruz⁷, F. Balaguer⁸, C. Lázaro¹, M. Pineda¹, G. Capellá¹
¹Hereditary Cancer Program, Catalan Institute of Oncology, ICO-IDIBELL and CIBERONC Hospitalet de Llobregat, Barcelona, ²Huntsman Cancer Institute, University of Utah Circle of Hope, Salt Lake City, UT, ³Pathology Department, Hospital Universitari de Bellvitge-IDIBELL Hospitalet de Llobregat, Barcelona, ⁴Research Unit in Translational Bioinformatics, Vall d'Hebron Research Institute (VHIR), Universitat Autònoma de Barcelona (UAB) Barcelona, ⁵Medical Clinic 1, Johann Wolfgang Goethe-University Frankfurt, ⁶Instituto de Medicina Oncológica y Molecular de Asturias (IMOMA) Oviedo, ⁷Research Unit in Translational Bioinformatics, Vall d'Hebron Research Institute (VHIR), Universitat Autònoma de Barcelona (UAB) - ICREA Barcelona, ⁸Department of Gastroenterology, Hospital Clínic, Centro de Investigación Biomédica en Red en Enfermedades Hepáticas y Digestivas (CIBERehd), Institut d'Investigacions Biomèdiques August Pi i Sunyer (IDIBAPS) Barcelona

The clinical spectrum of germline MMR gene variants keeps increasing, encompassing Lynch syndrome and Constitutional MMR Deficiency, to the recently reported MSH3-associated polyposis. Genetic diagnosis of these hereditary cancer syndromes is often hampered by the presence of variants of unknown significance (VUS) and overlapping phenotypes.

Two *PMS2* VUS, c.2149G>A (p.V717M) and c.2444C>T (p.S815L), were identified *in trans* in one individual diagnosed with early-onset colorectal cancer (CRC) belonging to a family fulfilling clinical criteria for hereditary cancer. Clinico-pathological data, multifactorial likelihood calculations and functional analyses were used to refine their clinical significance.

Likelihood analysis based on cosegregation and tumor data classified the c.2444C>T variant as pathogenic, which also demonstrated impaired MMR activity associated with diminished protein expression in functional assays. Conversely, the c.2149G>A variant displayed MMR proficiency and protein stability. These results, in addition to the conserved *PMS2* expression in normal tissues and the absence of germline microsatellite instability (gMSI) in the biallelic carrier ruled out a CMMRD diagnosis.

The use of comprehensive strategies, including functional assays, is mandatory to improve the clinical interpretation of naturally occurring MMR variants. This is critical for appropriate clinical management of cancer syndromes associated to MMR gene mutations.

PP200 - STANDARDIZATION OF THE IN VITRO MISMATCH REPAIR ASSAY USED FOR THE FUNCTIONAL CHARACTERIZATION OF VARIANTS IN MISMATCH REPAIR GENES

M. González-Acosta¹, A. Fernández¹, C. Lázaro¹, M. Pineda¹, G. Plotz², G. Capellá¹

¹Hereditary Cancer Program, Catalan Institute of Oncology, ICO-IDIBELL and CIBERONC Hospitalet de Llobregat, Barcelona, ²Medical Clinic 1, Johann Wolfgang Goethe-University Frankfurt

A significant proportion of DNA mismatch repair (MMR) variants are classified as variants of unknown significance (VUS), precluding diagnosis. The *in vitro* MMR assay is used to assess the mismatch repair capability of VUS, likely the most important function of a MMR protein (Heinen Hered Cancer Clin Pract 2012). However, robustness of the assay, critical for its routine use in the clinical setting, has not been evaluated. The aim of the present work was to standardize the *in vitro* MMR assay for the functional characterization of MMR variants meeting quality control standards of diagnostic laboratories.

The MMR assay was optimized by testing different mismatched pUC19CPDC plasmids as well as the dependency between the repair activity and the amount of total protein cell extracts, KCl concentration and incubation time. Then, reference materials and standardized operative procedures (SOP) for HEK293T cells transfection and whole cell protein extraction, nuclear proteins extraction, mismatched plasmid substrate generation and MMR assay were established. To determine the inter- and intra-experimental variability of the assay and its reproducibility among centers, three independent transfections of six previously characterized *MLH1* variants were performed in two independent laboratories.

The plasmid substrate with a mismatch-nick distance of 82 bp at 3'-orientation was chosen as optimal. Five µg of whole cell extract, 110mM KCl and 15 minutes of reaction time were established as optimal conditions to perform the MMR assay. No significant intraexperimental variability was observed in absolute repair of wildtype *MLH1* protein. No significant interexperimental variability was observed in the relative repair activity in the p.I219V and p.G67R pathogenic MMR variants compared to the wildtype even using independent preparations of nuclear extracts. Consistent results on the six *MLH1* variants analyzed were obtained in the two independent laboratories, establishing the reproducibility across centers.

We have developed a robust MMR assay strategy that can provide relevant *in vitro* evidence for the classification of VUS detected in MMR genes.

PP201 - GENETIC CHARACTERIZATION OF FAMILIES FROM SIRIO LIBANES HOSPITAL HEREDITARY CANCER REGISTRY, SAO PAULO, BRAZIL.

B. Rossi¹, E. Santos¹, C. SÃ¡¹, B. Garicochea¹, E. Oliveira¹, M. Diz¹, P. Hoff¹, S. Meirelles¹, R. Coudry¹, B. Lisboa¹, L. Reis¹

¹Sirio Libanes Hospital SÃ£o Paulo - Brazil

The Hereditary Cancer Registry of the Oncology Center, at Hospital Sirio Libanes, started its activities in 2013 with the objective of organizing the information of individuals and families at high risk for cancer due to family history, or due to early onset of cancer. Data from families submitted to Genetic Counseling since 2008 were included. There are few studies evaluating the profile of germline mutations in the Brazilian population. The main objective of this study is to present the profile of these families with suspected hereditary syndromes in a single institution in Sao Paulo city, Brazil. Collected data were: (a) family history; (b) clinical data from the proband electronic chart; (c) reports of genetic tests carried out by commercial laboratories to evaluate molecular characteristics. The database was built using Progeny® software. Between 2008 and 2016, 1,313 families were included into the Registry, and molecular evaluation was performed in 1,002. The most frequent molecular evaluation was the use of panels of multiple genes by NGS (650 probands), followed by gene sequencing by Sanger (212). Two hundred and five pathogenic mutations were diagnosed (20.5% - 205/1002). The most common genes with pathogenic mutations were: BRCA1 (52 probands), BRCA2 (37), TP53 (23), MUTYH (19 monoallelic), MSH2 (9), MLH1 (8) and PALB2 (6). Registration of families at high risk for cancer and its molecular characterization make possible to establish adequate management for the family, specially in poorly studied populations, such as in Brazil.

PP202 - A MUTATION IN CHECK2 CAUSING SIX DIFFERENT NEOPLASTIC TUMORS IN A SINGLE INDIVIDUAL

E. Half¹, N. Sharon-Schwartzman², A. Mori², T. Paperna², H. Baris²

¹Gastroenterology Haifa, ²Genetics Haifa

Cell Cycle Check point Kinase (*CHEK2*) has been shown to play a role in cell cycle regulation, apoptosis, and DNA repair. Several studies have reported associations of germline mutations in *CHEK2* with increased susceptibility to mainly breast and prostate cancer, however, recently *CHEK2* mutations have been detected also among lung, thyroid and young CRC patients.

Here we describe a novel homozygous missense mutation in *CHEK2* detected for the first time in a patient of Christian Arab descent in Israel.

A 70yr old male with history of diabetes and hypertension was initially referred to the GI cancer prevention service at 67yrs due to polyposis. At 35yrs due to rectal bleeding a colonoscopy was performed and 5 tubular adenomas (TA) were resected. Since then he has had colonoscopies at 2-3 yr intervals with 1-3 TA removed. A year prior to evaluation approximately 50 polyps 2-10 mm in size were detected.

His cancer history was positive for a thymoma at the age of 45 yrs, breast cancer at 65yrs and prostate cancer at 66yrs. Genetic counseling was performed and *APC*, *MutYH*, *BRCA1* and *BRCA2* sequencing were unremarkable. Prior to colectomy he was found to have a renal cell carcinoma on CT and was referred for a nephrectomy and subtotal colectomy which were uneventful. Beside the TAs a 35mm a sigmoid Gastrointestinal Stromal tumor was diagnosed.

His family history is significant for consanguinity and a niece that was diagnosed at 31yrs with breast cancer.

Next generation sequencing was performed using the Trusight One (Illumina) clinical exome panel, consisting of 4,800 genes. Variants selected according to keywords related to tumor phenotype, and filtered for frequency (minor allele frequency <0.01) in local or publically available variant databases, functional prediction-including non-synonymous, and truncating variants (missense, nonsense, frameshift, and splice-site), and mutation databases (e.g. ClinVar). Dominant and recessive modes of inheritance were considered, in view of the family history of the patient. A homozygous missense mutation G167R was identified in *CHEK2* and validated using Sanger sequencing. No other mutations in this gene panel could account for the cancer phenotype. The G167R variant is located in a domain involved in protein dimerization, and has been reported only in a heterozygous state or in a compound heterozygous state.

Conclusion: Here we describe a homozygous missense mutation in *CHEK2* suggested to cause adult onset multi-organ tumorigenesis

PP203 - PERFORMANCE OF IMMUNOHISTOCHEMICAL TEST ON COLORECTAL CANCERS TO IMPROVE LYNCH SYNDROME IDENTIFICATION

S. Signoroni¹, M. Vitellaro², M. T. Ricci¹, M. G. Tibiletti³, A. M. Chiaravalli³, I. Carnevali³, M. Milione⁴, V. Pensotti⁵, A. Morabito⁶, L. Bertario¹

¹Unit of Hereditary Digestive Tract Tumors, Preventive-Predictive Department - Fondazione IRCCS Istituto Nazionale dei Tumori Milan, Italy, ²Unit of Hereditary Digestive Tract Tumors, Preventive-Predictive Department; Colorectal Surgery Unit, Department of Surgery - Fondazione IRCCS Istituto Nazionale dei Tumori Milan, Italy, ³Department of Pathology, Ospedale di Circolo Asst Settelaghi Varese, Italy, ⁴Department of Pathology, Fondazione IRCCS Istituto Nazionale dei Tumori Milan, Italy, ⁵IFOM, FIRC Institute of Molecular Oncology Milan, Italy, ⁶University Of Milan Milan, Italy

Background

Several strategies have been developed to diagnose Lynch Syndrome (LS). Immunohistochemical (IHC) expression of Mismatch Repair (MMR) proteins and Microsatellite Instability (MSI) on Colorectal Cancer (CRC) tissue are considered sensitive and cost-effective methods to identify LS patients therefore there is no consensus on the best algorithm for this purpose.

Aims

To evaluate the effectiveness of a CRC selective screening for LS by IHC and MSI in a retrospective study of an institutional Hereditary Tumors Registry.

Methods

A retrospective (from 1999 to 2014) database analysis of 683 CRC patients suspected for LS was carried out. IHC results of MMR genes and MSI analysis were assessed respectively in 593 and 525 CRC, while germline analysis was performed in 418 patients (61%) according to test results or clinical features.

Sensitivity, specificity, positive predictive values of IHC and MSI approach alone or IHC combined with MSI were evaluated and the presence of a MMR germline causative variants was considered the referred gold standard.

Clinical features (Amsterdam-Criteria, CRCs site, age of onset, stage, grading, endometrial cancer presence) have been evaluated too.

Results

In 201 patients (29%) IHC was defective, high microsatellite instability (MSI-H) was identified in 168 (25%) while IHC defective associated to MSI-H in 161 (35%). In 144 patients a germline MMR variant (81 hMLH1, 54 hMSH2, 9 hMSH6) was diagnosed so PPV, Sensitivity, Specificity were 67%, 93%, 77% for IHC, 64%, 98%, 74% for MSI and 63%, 98%, 75% for IHC defective + MSI-H respectively.

At univariate and multivariate analysis, IHC result was the most relevant and independent factor for Mismatch Repair (MMR) germline variant detection (OR of 8.11).

The performance for LS identification of IHC and MSI alone or combined was evaluated and no statistical differences were observed for the parameters of the three different approaches.

Conclusions

The study underline the role of IHC tumor testing as tool to set up screening for LS diagnosis. Even if IHC and MSI analysis had similar efficiency, IHC results a low cost-effective approach to diagnose LS with a good performance in terms of sensitivity, specificity and positive predictive value.

PP205 - DEEP INTRONIC SEQUENCING OF MUTATION-NEGATIVE LYNCH SYNDROM PATIENTS

A. M. Nissen¹, M. Morak², C. Rapp¹, A. Laner³, A. Benet-Pagã"s¹, E. Holinski-Feder²

¹MGZ "Medizinisch Genetisches Zentrum Munich, ²Medizinische Klinik und Poliklinik IV, Campus Innenstadt, Klinikum der Universitãt Mãnchen and MGZ "Medizinisch Genetisches Zentrum Munich, ³MGZ - Medizinisch Genetisches Zentrum Munich

Lynch Syndrome (LS) is caused by germline mutations in genes involved in the DNA mismatch repair (MMR) pathway, and frequently indicated by a high microsatellite-instability and a loss of immunohistochemical staining (IHC) of the protein in tumor tissue. The mutation detection rate of pathogenic variants in our patients with MMR-defects is 65%, in 17% variants of uncertain significance were detected, and in 18% no variation was found in routine diagnostics. Hence, for a considerable number of patients with MMR-defects in the tumor and familial tumor clustering in many cases the causative genetic predisposition cannot be identified. We set up a cohort of 128 index patients with MMR-defect in their tumor and no pathogenic germline mutation in the corresponding MMR gene detectable in previous analyses (Sanger sequencing, MLPA), and 12 patients with known copy number variations (CNVs) but missing breakpoints. To uncover further pathomechanisms in this cohort we performed deep intronic sequencing of 8 genes associated with LS or involved in the MMR pathway (MLH1, MLH3, PMS1, PMS2, MSH2, MSH3, MSH6, EPCAM). All exons, introns and chromosomal regions far upstream/downstream of the genes were included in the target region, allowing for detection of variants in regulatory regions and chromosomal rearrangements. Library preparation was done with the SureSelectXT Reagent Kit and capture enrichment with a custom-made SureSelectXT Kit. We used paired-end sequencing on an Illumina NextSeq system. Data was analyzed using an in-house bioinformatics pipeline for single nucleotide variants (SNVs), CNVs and structural rearrangements. SNV analysis of the 128 index patients solved the pathomechanism for 11 patients. In two mutation-positive cases our analysis of all MMR genes revealed a wrong IHC result in the tumor whereupon the wrong MMR genes were analyzed previously. For 5 of 12 CNV positive patients, we were able to detect the exact break points with our structural variation pipeline. Thereby, we could determine the position of the duplicated gene regions in 2 duplication events which helps to explain the underlying pathomechanism. In one patient with a combined IHC loss of MLH1/PMS2 in the tumor, a monoallelic expression of MLH1 was demonstrated in cDNA analyses. In this patient, our structural variation pipeline detected a complex rearrangement on chromosome 2 that causes a paracentric inversion between the DCLK3 gene and MLH1. In another patients with IHC loss of PMS2 we detected a large insertion on chromosome 7 in PMS2.

PP208 - THE MSH2 EXON 5 DELETION (C.792+8_943-450DEL) IS A FOUNDER MUTATION IN PORTUGUESE LYNCH SYNDROME FAMILIES WITH A CENTER-SOUTH ANCESTRY

I. Francisco¹, B. Filipe¹, I. Claro², P. Lage², S. Ferreira², I. Rosa², R. Fonseca³, P. Rodrigues⁴, J. Dupont⁵, P. Theisen⁶, A. Pereira-Caetano⁶, G. IsÁdro⁶, J. GonÁsalves⁶, A. B. Sousa⁷, P. Chaves³, A. Dias Pareira⁸, C. Albuquerque¹

¹Molecular Pathobiology Research Unit - Portuguese Institute of Oncology Francisco Gentil, EPE Lisbon, ²Familial Cancer Risk Clinic and Gastroenterology Department - Portuguese Institute of Oncology Francisco Gentil, EPE Lisbon, ³Pathology Department - Portuguese Institute of Oncology Francisco Gentil, EPE Lisbon, ⁴Familial Cancer Risk Clinic - Portuguese Institute of Oncology Francisco Gentil, EPE Lisbon, ⁵Genetics Department - Sta. Maria Hospital, CHLN, EPE and Familial Cancer Risk Clinic - Portuguese Institute of Oncology Francisco Gentil, EPE Lisbon, ⁶Human Genetic Department - Ricardo Jorge Institute Lisbon, ⁷Genetics Department - Sta. Maria Hospital, CHLN, EPE Lisbon, ⁸Gastroenterology Department - Portuguese Institute of Oncology Francisco Gentil, EPE Lisbon

Lynch syndrome (LS) is a hereditary colorectal cancer syndrome caused by germline mutations in the DNA mismatch repair (MMR) genes. Worldwide, large genomic deletions, particularly in *MSH2* gene, account for ~17% of the mutational spectrum. A total of 14 unrelated families, with a recurrent exon 5 genomic deletion in *MSH2* gene, were identified during genetic testing amongst those followed at the Portuguese Oncology Institute of Lisbon and Hospital de Sta. Maria, in Lisbon. This mutation was not identified in families followed at other Portuguese Oncology Institutes. After the confirmation, by Sanger sequencing, that all the families shared the same deletion breakpoints (c.792+8_943-450del) we aimed to evaluate a possible founder effect of this mutation. A haplotype analysis was performed using 9 microsatellite markers flanking *MSH2* and 3 intragenic SNPs, in a total of 55 individuals (14 index patients and 41 relatives). The geographical origin of these families was also evaluated and the age of the mutation estimated. Five different haplotypes were phased for 6 of the 14 families, which share a common haplotype of 3.2Mb. Based on the mutation and recombination events, observed in the microsatellite haplotypes, and assuming 25 years per generation, it was possible to estimate that this mutation occurred 234±78 years ago. Our data suggests that the *MSH2* c.792+8_943-450del is a founder mutation in Portugal, which is reinforced by the fact that the great majority of the families shared a common geographical origin in the center region of Portugal. Moreover, the prevalence of this mutation in our LS registry indicates that screening of this mutation, using Multiplex Ligation Probe dependent Amplification (MLPA), should be considered a first and cost-effective approach in the genetic diagnosis of suspected LS families with a Portuguese ancestry, especially in those with a Center-South origin.

PP207 - CONCORDANCE OF MULTI-GENE PANEL TESTING WITH PRIOR MICROSATELLITE INSTABILITY AND IMMUNOHISTOCHEMISTRY ANALYSES

C. Espenschied¹, K. Jasperson¹, H. Hampel², P. Reineke¹, T. Pesaran¹, I. Frayling³

¹Ambry Genetics Aliso Viejo, CA, ²The Ohio State University Comprehensive Cancer Center Columbus, OH, ³Cardiff University Cardiff, UK

Background: Use of microsatellite instability (MSI) and/or immunohistochemistry (IHC) are accepted methods of screening for Lynch syndrome but their sensitivity and specificity are not 100%. Additionally, the concordance of these tests with constitutional mutations is not well understood particularly in the setting of multi-gene panel testing (MGPT). We aimed to compare test results in an MGPT cohort of individuals with prior MSI and/or IHC (tumor testing).

Methods: Clinical data and previous tumor testing results were extracted from the test request forms of consecutive patients undergoing MGPT at a single laboratory between March 2012 and June 2016. Cases for which results of tumor testing were provided were selected and classified as concordant if they matched MGPT results, discordant if they did not match MGPT results, and atypical if they had both concordant and discordant features .

Results: We identified 3870 eligible cases. Tumor testing and MGPT results were concordant in 73.2%, discordant in 25.8%, and atypical in 1.0% of cases. Of discordant cases (n=993), 86.2% had abnormal IHC with no constitutional MMR gene mutation, while 10.1% had high MSI, no or normal IHC, and no MMR mutation, 2.4% had normal tumor testing with an MMR mutation, and 0.9% had loss of protein(s) discordant from the MMR mutation. The majority of discordant cases (53.9%) had loss of MLH1 or MLH1/PMS2. Among all cases with loss of MLH1 or MLH1/PMS2 (n=658), 8.1%, had a constitutional mutation in *MLH1* or *PMS2*, 11.7% had *MLH1* promoter methylation and/or *BRAF* mutation, and 80.2% were unexplained. Among cases with loss of PMS2 (n=101), 34.7% had a *PMS2* mutation and 65.3% were unexplained. Among cases with loss of MSH2 or MSH2/MSH6 (n=234), 38.0% had an *MSH2* or *MSH6* mutation and 62.0% were unexplained. Of those with loss of MSH6 (n=120), 34.2% had an *MSH6* mutation and 65.8% were unexplained. Of 960 cases with abnormal tumor testing and no MMR mutation, 30 had a mutation in another gene.

Conclusions: In this cohort, over 25% of tumor testing results were discordant with MMR gene test results. There are several possible explanations for this including two somatic MMR mutations, unclassified variants, missed mutations, and inaccurate tumor testing. These results provide guidance for clinicians on what to expect from MGPT in a patient with given tumor test results, suggest scenarios where somatic gene testing may be useful, and highlight several opportunities for further study.

PP209 - CONTRIBUTION OF MUTYH GERMLINE MUTATIONS TO EARLY ONSET NON-POLYPOSIIS COLORECTAL CANCER

B. Filipe¹, J. Moleiro², C. Albuquerque¹, I. Francisco¹, P. Lage³, I. Claro³, S. Ferreira³, I. Rosa³, P. Rodrigues⁴, R. Fonseca⁵, P. Chaves⁵, A. Dias Pereira²

¹Molecular Pathobiology Research Unit (UIPM), Portuguese Institute of Oncology Francisco Gentil, EPE Lisbon, ²Department of Gastroenterology, Portuguese Institute of Oncology Francisco Gentil, EPE Lisbon, ³Department of Gastroenterology, Familial Cancer Risk Clinic, Portuguese Institute of Oncology Francisco Gentil, EPE Lisbon, ⁴Familial Cancer Risk Clinic, Portuguese Institute of Oncology Francisco Gentil, EPE Lisbon, ⁵Department of Pathology, Portuguese Institute of Oncology Francisco Gentil, EPE Lisbon

Introduction: The incidence of colorectal cancer (CRC) in young patients (diagnosed at age ≤ 50), with or without a weak family history of CRC, is increasing and, in the majority of cases, the underlying genetic causes for CRC susceptibility remain unclear. These patients are suspected of Lynch syndrome and should undergo microsatellite instability (MSI) testing and/or immunohistochemical analysis of mismatch repair (MMR) proteins. Some studies have shown that mutations in genes associated with hereditary syndromes, like *MUTYH*, may explain a small percentage of CRC at young age. We aimed to evaluate the contribution of *MUTYH* germline mutations to early onset non-polyposis CRC from our Familial Cancer Registry. **Materials and methods:** We performed *MUTYH* mutation analysis using next-generation sequencing and MLPA. MSI and MMR immunohistochemical analysis were performed whenever tumor was available. Statistical analysis: STATA 12. **Results and discussion:** So far, *MUTYH* mutation analysis was performed in 38 patients (16 male:22 female; mean age: 40, 23-50). Clinical features: CRC localization (proximal-9; distal-12; rectum-13); 41% of the patients presented adenomas (1-5), 3 cases only with serrated adenomas; 12% and 21% of the patients presented familial history of CRC or adenomas, respectively; 21% showed familial history of other neoplasias. 13% of CRC were MSI-high, 19% MSI-low and 68% MSS. Amongst CRC showing MSI-H, all showed absence of MLH1/PMS2 expression (4/4). No *MUTYH* biallelic mutations were found. *MUTYH* mono-allelic mutations were detected in 2/38 (5%) patients, in both cases the hotspot G396D. This is in agreement with the higher frequency of G396D relatively to the other hotspot (Y179C) in the Iberian Population. The age at CRC diagnosis in these two patients was 37 and 39, respectively, and both tumours were MSS. The former patient presented 4 serrated adenomas and a family history of adenomas whereas the latter had no personal or family history of adenomas.

Our results suggest that biallelic *MUTYH* mutations are relatively rare in young (≤ 50) non-polyposis CRC patients from Southern Portugal. On the other hand, we observed a high prevalence of monoallelic *MUTYH* mutations in our cohort, which may result from the small patient's group. However, one cannot exclude, in agreement with previously reports, a modestly increased risk for the development of adenomas and cancer in monoallelic carriers.

PP210 - RESULTS OF THE NGS ANALYSIS IN PATIENTS WITH SUSPECTED HEREDITARY COLORECTAL CANCER DUE TO FAMILY HISTORY

B. Rossi¹, E. Santos¹, C. SÃi¹, B. Garicochea¹, E. Oliveira¹, M. Diz¹, P. Hoff¹, S. Meireles¹, R. Coudry¹, B. Lisboa¹, L. Reis¹

¹Sirio Libanes Hospital SÃ£o Paulo - Brazil

Molecular evaluation by NGS may contribute to the identification of patients with hereditary predisposing cancer syndromes. Few studies are available evaluating NGS results in Brazilian patients. This study aims to evaluate the clinical and molecular characteristics of patients with suspected hereditary colorectal cancer (HCCR) submitted to NGS evaluation. It is a retrospective study that used data available in the Registry of Hereditary Cancer (RHC) of the Hospital SÍrio-LibanÊs, Sao Paulo, Brazil. We included families with suspected hereditary cancer that were evaluated between 2008 and 2016 and who had family history, clinical and molecular history included in the RHC. Molecular analysis by NGS was performed in commercial laboratories, and mutation data were recorded. During the period evaluated, 575 NGS tests were performed, of which 76 were in patients with suspected HCCR. We identified 16 pathogenic mutations and 19 VUS. Among the genes with identified pathogen mutations we found: 4 MLH1, 4 MUTYH, 4 PMS2, 2 PALB2, and 1 in APC, MITF, MSH2, PMS1, and TP53 genes. Among the clinical criteria used for inclusion in the registry and the presence of pathogenic mutation, we found that 5 probands presented Amsterdam Criteria, 3 had cancer diagnosed before 50 years without family history, 3 had colorectal cancer diagnosed with family member with CRC, 2 patients presented between 10 and 100 polyps and 1 had more than 100 polyps. Of the total, four patients with a pathogenic mutation did not present any of the clinical criteria mentioned previously. The detection of pathogenic mutation in the group was 21%, and it is highlighted that four patients with pathogenic mutation did not present any of the clinical criteria of the literature for HCCR.

PP211 - CANCER PREVALENCE IN LYNCH SYNDROME PATIENTS: PRELIMINARY RESULTS OF A MULTICENTER NATION-WIDE STUDY

A. SÁnchez¹, M. Navarro², T. Ocaña¹, M. Pineda², L. Moreno¹, F. Rodríguez-Moranta³, A. Soriano³, T. Ramon y Cajal⁴, G. Llorca⁵, C. Yagüe⁵, M. D. Picó⁶, R. Jover⁶, A. López⁷, E. Martínez de Castro⁸, C. Álvarez⁹, X. Bessa⁹, L. Rivas¹⁰, D. Rodríguez-Alcalde¹¹, A. Dacal¹², M. Herraiz¹³, C. Garau¹⁴, L. Bujanda¹⁵, L. Cid¹⁶, C. Poves¹⁷, M. Garzán¹⁸, A. Pizarro¹⁸, A. Gomez¹⁹, I. Salces²⁰, M. Ponce²¹, M. Carrillo-Palau²², E. Aguirre²³, E. Saperas²⁴, A. Virgili⁴, D. Fisas⁴, V. Piñol²⁵, S. Carballal¹, L. Rivero¹, M. Pellise¹, M. Serra²⁶, J. Balmaña⁷, J. Brunet², A. Castells¹, G. Capellán², L. Moreira¹, F. Balaguer¹

¹Hospital Clinic Barcelona Barcelona, ²Institut Català d'Oncologia Barcelona, ³Hospital Universitari de Bellvitge Hospitalet de Llobregat, ⁴Hospital de la Santa Creu i Sant Pau Barcelona, ⁵Corporació Sanitària Parc Taulí i Consorci Sanitari de Terrassa Sabadell-Terrassa, ⁶Hospital Universitario de Alicante Alicante, ⁷Hospital Universitari Vall d'Hebron Barcelona, ⁸Hospital Universitario Marqués de Valdecilla Santander, ⁹Hospital del Mar Barcelona, ¹⁰Complexo Universitario Hospitalario de Ourense Ourense, ¹¹Hospital Universitario de Asturias Asturias, ¹²Hospital Universitario Lucus Augusti Lugo, ¹³Clínica Universitaria de Navarra Pamplona, ¹⁴Hospital de Son Llàtzer Palma de Mallorca, ¹⁵Hospital de Donostia Donostia, ¹⁶Hospital Álvaro Cunqueiro Vigo, ¹⁷Hospital Clínico San Carlos Madrid, ¹⁸Hospital Universitario Virgen Del Rocío Sevilla, ¹⁹Hospital Universitario de Guadalajara Guadalajara, ²⁰Hospital 12 de Octubre Madrid, ²¹Hospital Universitari I Politècnic La Fe Valencia, ²²Hospital Universitario de Canarias Tenerife, ²³Hospital Quiron de Zaragoza Zaragoza, ²⁴Hospital General de Catalunya Barcelona, ²⁵Hospital Josep Trueta Girona, ²⁶Universitat de Barcelona-Centre de Recerca en Economia i Salut (CRES-UPF) Barcelona

Background and Aims: Lynch syndrome (LS) is caused by germline mutations in the mismatch DNA repair system (MLH1, MSH2, MSH6, PMS2) and predisposes to colorectal, endometrial and other tumors. Estimates of cancer risk in LS have been frequently biased due to retrospective and small cohorts. We set up a multicenter nation-wide study with the following aims: 1) create a national register of LS cases 2) establish the prevalence and cumulative incidence of colorectal cancer (CRC) and other cancers and 3) assess the cancer-specific survival. Herein we report the first preliminary analysis focused on the prevalence of CRC and other tumors.

Patients and Methods: multicenter nation-wide study in Spain, with retrospective collection of prospectively observed data in the setting of organized high-risk clinics. A centralized online database was used, including demographic, genetic, family and personal cancer history, pedigree data, and surveillance protocol and treatments. First prospectively colonoscopy planned as LS screening-surveillance was considered as date of inclusion. CRCs diagnosed prior or within 6-months of the beginning of follow-up were considered as prevalent cancers.

Results: 1,108 LS patients from 25 centers were included [MLH1, 449 (40.5%); MSH2, 371 (33.5%); MSH6, 197 (17.8%); PMS2, 68 (6.1%); EPCAM, 23 (2.1%)] and followed-up for a mean of 67.5+57.8 months. Mean age was 52.4 +15.4, and 630 (56.9%) were female. Mean age at inclusion was 45.2+15.

CRC was present in 426 (38.4%) LS patients [MLH1, 204 (48%); MSH2, 140 (33%); MSH6, 47 (11%); PMS2, 23 (5%); EPCAM, 12 (3%)] and 114 were diagnosed with more than one CRC. First CRC under screening with colonoscopy was found in 49 / 713 (6.7%) patients (MLH1, n=23/268; MSH2, n=18/249; MSH6, n=4/154; PMS2, n=2/47; EPCAM, n=2/13).

Two-hundred-sixteen (19.5%) LS patients had cancer in other locations: 119 endometrial (18.8% woman) [MLH1, 39 (32.8%); MSH2, 47 (39.5%); MSH6, 31 (26.1%); PMS2, 1 (0.8%); EPCAM, 1 (0.8%)], 26 ovarian (4.12% of woman), 12 gastric (1%), 17 urinary bladder (1.5%), 20 ureter (1.8%), 21 skin (1.9%), 19 breast (1.7%) and 9 prostate cancer (0.8%).

Conclusions: In this large multicenter study, a preliminary analysis shows a 38.4% prevalence of CRC in LS patients, in our geographic region; with a 6.7% prevalence of CRC in those patients without a cancer at inclusion time. Endometrial cancer is present in 20% of LS patients. Further cumulative incidence studies will be needed to evaluate the risk of cancer and improve the management of LS families.

PP213 - TO NMD AND BEYOND: IDENTIFYING MUTATIONS IN THE 3'™ TERMINUS OF MISMATCH REPAIR GENES

B. Smith¹, R. Karam¹, K. Jaspersen¹, T. Pesaran¹

¹Ambry Genetics Aliso Viejo, CA

Background: Protein truncating alterations in tumor suppressor genes such as the mismatch repair genes *MLH1*, *MSH2*, *MSH6* and *PMS2* are typically deleterious. However variants that occur at the 3' terminus of genes are not expected to trigger nonsense-mediated mRNA decay (NMD), resulting in a truncated protein. What functional impact the loss of these distal amino acids may cause remains unclear without additional evidence. Our aim was to describe the most 3' protein truncating alterations classified as pathogenic or likely pathogenic that have been identified in the Ambry Genetics cohort.

Methods: The NMD boundary is defined as being 55 nucleotides from the 3' end of the penultimate exon in each gene. We queried the Ambry Genetics variant database for all indels, frameshift and nonsense alterations identified to date beyond the NMD boundary for *MLH1*, *MSH2*, *MSH6* and *PMS2*. Publicly available variant databases were also searched for entries identified downstream of the most distal alteration found at Ambry.

Results: Truncating alterations were identified in each of the mismatch repair genes: *MLH1* (19), *MSH2* (17), *MSH6* (19) and *PMS2* (8). The most 3' truncating alterations with enough evidence to be classified as pathogenic or likely pathogenic were *MLH1* c.2252_2253delAA (p.K751SFS*3), *MSH2* c.2680dupA (p.M894Nfs*5), *MSH6* c.4004_4007dupAAGT (p.C1337SFS*5) and *PMS2* c.2534delA (p.H845LFS*6). *MSH2* and *MSH6* both have variants of uncertain significance downstream of the mutations reported here, while we have not seen any variants 3' of the *MLH1* and *PMS2* mutations. Although variants have been reported beyond these alterations in available databases, their degree of pathogenicity remains uncertain.

Conclusion: Truncating alterations in the 3' end of genes may or may not lead to disease. Due to the uncertainty surrounding the functional impact of these alterations, clinical evidence and tumor testing data are essential in determining pathogenicity. Identifying the most distal known pathogenic mutation would provide evidence to classify other C-terminal truncating alterations upstream as pathogenic or likely pathogenic and those downstream would be classified as uncertain without additional evidence. Here we report the most distal mutations in *MLH1*, *MSH2*, *MSH6* and *PMS2* identified in our laboratory. As the evidence used in these classifications may be dependent on data from the laboratory, the need for continued data sharing efforts is of great importance.

PP214 - FINDING THE GENETIC CAUSE IN SUSPECTED LYNCH SYNDROME PATIENTS

A. M. L. Jansen¹, M. A. Geilenkirchen², T. van Wezel¹, S. C. Jagmohan-Changur², D. Ruano¹, H. M. van der Klift³, B. E. W. M. van den Akker¹, J. F. J. Laros², M. van Galen², A. Wagner⁴, T. G. W. Letteboer⁵, E. B. GÃmez-GarcÃa⁶, C. M. J. Tops³, H. F. Vasen⁷, P. Devilee², F. J. Hes³, J. T. Wijnen³, H. Morreau¹

¹Department of Pathology, Leiden University Medical Center Leiden, The Netherlands, ²Department of Human Genetics, Leiden University Medical Center Leiden, The Netherlands, ³Department of Clinical Genetics, Leiden University Medical Center Leiden, The Netherlands, ⁴Department of Clinical Genetics, Erasmus University Medical Center Rotterdam, The Netherlands, ⁵Department of Medical Genetics, University Medical Center Utrecht, Utrecht, The Netherlands, ⁶Department of Clinical Genetics, Maastricht University Medical Center Maastricht, The Netherlands, ⁷Department of Gastroenterology and Hepatology, Leiden University Medical Center Leiden, The Netherlands

Background and Aims: Up to 60% of mismatch repair (MMR) deficient colorectal cancer cases are categorized as suspected Lynch Syndrome (sLS) because no pathogenic germline variant can be identified. We investigated the possible genetic predisposition of 100 sLS patients with a stepwise approach, looking for missed germline MMR variants, (biallelic) somatic inactivation of the MMR genes or variants in other genes.

Methods: Of this retrospective cohort, leukocyte DNA (n=100) and tumor DNA (n=79) was available. In 33 patients the entire non-repetitive genomic sequence, including intronic and regulatory sequences of 15 colorectal cancer susceptibility genes was analyzed in leukocyte DNA with next-generation sequencing (NGS). Additionally, a Multiplex Ligation-dependent Probe Amplification (MLPA) of 29 cancer susceptibility genes was performed. Finally, of 79 patients tumor DNA isolated from formalin-fixed paraffin-embedded (FFPE) tissue blocks was analyzed for somatic MMR variants as well as for variants in the *POLE* and *POLD1* exonuclease domain (EDM).

Results: After testing leukocyte DNA for missed (intronic) variants with NGS, only one unexplained patient with solitary PMS2 loss in the tumor was found to carry a pathogenic *MLH1* variant. Five patients carried a MMR variant which was previously classified as a variant of unknown significance (VUS), but was reclassified as pathogenic. With MLPA, two patients were found to carry large deletions/duplications in *BRCA1* or *RAD51D*. After NGS on tumor DNA, 17 patients were found to have biallelic somatic inactivation of the MMR gene that showed immunohistochemical loss. Additionally, 10 patients carried a *POLE/POLD1* EDM variant.

Conclusions: In a large study we examined the possible underlying genetic cause in 100 sLS patients. Six patients (6%) carried a pathogenic MMR variant, which was previously classified as a VUS (n=5) or not detected (n=1). The tumors of seventeen patients (17%) were reclassified as sporadic due to biallelic somatic inactivation. Twelve patients (12%) carried a pathogenic variant in other cancer susceptibility genes, either *BRCA1* (n=1), *RAD51D* (n=1), *POLE* (n=8) or *POLD1* (n=2). The *POLE/POLD1* mutated tumors seemed to show an ultramutated phenotype, with secondary MMR-deficiency. The remaining unexplained patients will be analyzed with RNA sequencing and whole exome sequencing.

PP217 - MICROSATELLITE INSTABILITY-LOW AND LOSS OF HETEROZIGOSITY IN 2P MAY UNDERLIE INCREASED SUSCEPTIBILITY FOR FAMILIAL RECTAL CANCER

C. Albuquerque¹, M. Duarte¹, P. Silva¹, B. Filipe¹, I. Francisco¹, P. Lage², I. Claro², S. Ferreira², I. Rosa², R. Fonseca³, P. Rodrigues⁴, P. Chaves³, A. Dias Pereira⁵

¹Molecular Pathobiology Research Unit- Portuguese Institute of Oncology Lisbon Francisco Gentil Lisbon, ²Familial Cancer Risk Clinic and Gastroenterology Department- Portuguese Institute of Oncology Lisbon Francisco Gentil Lisbon, ³Pathology Department- Portuguese Institute of Oncology Lisbon Francisco Gentil Lisbon, ⁴Familial Cancer Risk Clinic - Portuguese Institute of Oncology Lisbon Francisco Gentil Lisbon, ⁵Gastroenterology Department- Portuguese Institute of Oncology Lisbon Francisco Gentil Lisbon

Revised Bethesda guidelines (BG) identifies colorectal cancer (CRC) patients suspected of Lynch syndrome (LS), that do not fulfill Amsterdam criteria, to be tested for microsatellite instability (MSI) in the respective tumors, an hallmark of LS. Patients fulfilling BG whose tumors present MSI-high (MSI-H) should undergo germline mutation analysis for DNA mismatch-repair (MMR) genes. MMR gene mutations define LS and are found in approximately 40% of patients with MSI-H tumors. However, the molecular basis underlying increased CRC susceptibility in the remaining cases fulfilling BG is still unknown.

We aimed to characterize patients with CRC fulfilling BG but without germline MMR gene mutations, for MSI status, namely regarding dinucleotide (DNR) or mononucleotide repeat (MNR) sequences, and for specific BG characterization, tumor stage and location in the colon and rectum.

We selected 225 patients with CRC fulfilling the BG from our Familial Cancer Registry, having germline MMR gene mutations excluded: 121 microsatellite stable (MSS) and 104 MSI tumors- 63 MSI-H and 41 MSI-low (MSI-L). MSI analysis have been performed by analyzing the Bethesda microsatellite markers (3 DNR–D2S123, D5S346, D17S250 and 2 MNR–BAT25, BAT26), using GeneScan. Loss of heterozygosity (LOH) at DNR was also evaluated. Correlation with clinical features was performed using Stata 12.

Amongst MSI-L tumors, only two were MSI at MNR; in the MSI-H group, 3 presented MSI only at MNR, whereas 5 showed MSI only at DNR. Interestingly, MSI-L tumors were associated to BG#5 (family history of CRC in 3 family members irrespective of age at diagnosis) (44%) and MSS or MSI-H tumors were associated to BG#1-4 (65% and 87%, respectively), $p=0,002$. MSI-L was more frequent in DNR and in these cases it was associated to rectal tumors (71%). MSI at both MNR and DNR was associated to proximal colon (71%), $p=0,003$. MSI at DNR and LOH of D2S123 correlated with BC#5 ($p=0.005$ and $p=0.045$, respectively). D2S123 LOH also correlated with earlier stage tumors ($p=0.035$). Copy number variation at D2S123 *locus*, in comparison with the matched normal mucosa, was confirmed by qPCR in 10/13 tumor samples from patients fulfilling BG#5, and in 6, LOH was also detected in flanking microsatellite markers.

Our results suggest that MSI-L at DNR and D2S123 LOH may be associated to increased susceptibility for familial rectal cancer, often early stage tumors.

PP219 - GENETIC ALTERATIONS OF WNT PATHWAYS IN FAMILIAL VERSUS SPORADIC POLYPS

M. C. Curia¹, F. Fantini¹, G. Fabietti¹, A. Ricci¹, C. Moscatello¹, K. Efthymakis², M. Neri², R. Valanzano³, A. Cama⁴, G. Aceto¹

¹Department of Medical, Oral and Biotechnological Sciences, ²G. d'Annunzio University Chieti, ³Department of Medicine and Aging Sciences, ⁴G. d'Annunzio University Chieti, ³Department of Surgery and Translational Medicine, Careggi University Hospital Firenze, ⁴Department of Pharmacy Chieti

In previous work we supported the inclusion of germline ASE (allele specific expression) analysis and screening of polyposis genes in algorithms for genetic diagnosis of hereditary forms of colorectal cancer. In the present work we are analyzing gene expression in tissue samples from a series of patients with polyposis, familial and sporadic to gain insights into the role of somatic expression of *APC* and other components of canonical and non canonical Wnt pathways in colorectal polyposis.

Individuals with age ≥ 18 years were included and patients with inflammatory bowel disease were excluded. Normal colonic mucosa were collected from donors with no family history of cancer as control. mRNA expression levels were investigated by qRT-PCR. The correlation among clinical and molecular features was evaluated.

We analyzed *APC* expression in 11 patients with FAP (familial adenomatous polyposis) with and without *APC* mutation, and 25 with sporadic adenomas (overall, 26 colon tumour tissues and 19 adjacent mucosa) and in normal colonic mucosa from 12 healthy controls. qRT-PCR showed a reduced *APC* expression in colon tumour tissues as compared to the adjacent mucosa. The differences in *APC* expression between colon tumour tissues and adjacent mucosa in familial and sporadic cases were statistically significant in the familial group. We also correlated *APC* expression with age. In patients the expression levels tend to decrease more rapidly with age. Instead in control group there is a constant *APC* expression trend in life. Correlation with sex showed that the *APC* reduced expression is more evident in men than in female. Intriguingly the *APC* expression in polyp-adjacent colonic mucosa was higher also compared to healthy controls colonic mucosa. Wnt pathway *BCL9* and *LEF1* downstream components and *Wnt5a* and *Wnt3a* ligands showed a reduced expression in adjacent colonic mucosa vs adenomas. Expression analysis of other Wnt components is in progress.

This study showed that the *APC* gene is less expressed in colon tumor tissue compared to the adjacent mucosa either in familial or in sporadic polyps, but it is more expressed in adjacent mucosa compared to the mucosa of healthy controls. The increased *APC* expression in adjacent mucosa could be due to a cross talk between tumor and surrounding colonic epithelium. *BCL9*, *LEF1*, *Wnt5a* and *Wnt3a* showed an opposite trend compared to *APC*, suggesting the involvement of noncanonical Wnt signalling in adenoma formation.

PP220 - REMOVAL OF A COMPLEX POLYP INVOLVING THE ILEOCECAL VALVE

E. Gorgun¹, I. Sapci¹

¹Department of Colorectal Surgery, Digestive Disease Institute, Cleveland Clinic Cleveland

Removal of a complex polyp involving the ileocecal valve

Ipek Sapci, Emre Gorgun

Endoscopic submucosal dissection (ESD) with removal of premalignant lesions larger than 20 mm and early stage tumors of the colon can be applied. It consists of several steps to elevate, incise and excise the lesion.

Lesions at or near the ileocecal valve (ICV) are challenging for endoscopic removal and are usually managed surgically due to difficult anatomic location and limited scope flexibility. Due to aforementioned reasons, treating lesions at this location are technically demanding.

For the lesions involving ICV, incision should be extended to include parts of the ileal lips to achieve clear surgical margins. Dissection should be carried out in a stepwise manner to ensure the distinction between normal valve tissue and the neoplasia.

In this case we demonstrate an endoscopic submucosal dissection and successful removal of a 30 mm lesion involving the proximal lip of the ileocecal valve. A 55 year old patient was referred to our practice after undergoing screening colonoscopy where this lesion was discovered. Endoscopic biopsies revealed a tubulovillous adenoma and patient underwent ESD. The lesion was resected in an en bloc fashion with negative margins. During the procedure, ileocecal valve and ileum were continually visualized to avoid any damage to the normal tissue. The patient was discharged home after an uneventful recovery on postoperative day 1.

PP221 - EUROPEAN CDNA MISMATCH REPAIR WORKING GROUP: COMPARISON OF DISTINCT STRATEGIES AND RECOMMENDATIONS FOR BEST PRACTICE IN RNA SPLICING ANALYSIS

M. Morak^{*1}, A. Martins^{*2}, M. Pineda^{*3}, H. Tubeuf⁴, P. Gaildrat², C. GÃmez³, E. DÃjmaso³, A. Laner⁵, J. Abdat², K. Chauris², E. Holinski-Feder^{**1}, G. CapellÃj^{**3}

¹Medizinische Klinik und Poliklinik IV, Campus Innenstadt, Klinikum der UniversitÃt MÃnchen, Munich, Germany and MGZ â€“ Medizinisch Genetisches Zentrum.. Munich, ²Inserm-U1245, UNIROUEN, Normandie Univ, Normandy Centre for Genomic and Personalized Medicine, Rouen, France Rouen, ³Hereditary Cancer Program, Catalan Institute of Oncology, IDIBELL and CIBERONC, Barcelona, Spain Barcelona, ⁴Inserm-U1245, UNIROUEN, Normandie Univ, Normandy Centre for Genomic and Personalized Medicine, Rouen, France and Interactive Biosoftware, Rouen, France Rouen, ⁵MGZ â€“ Medizinisch Genetisches Zentrum, Munich, Germany Munich

Over 20% of the germline mismatch repair (MMR) gene variants detected in patients suspected of Lynch syndrome are currently classified as variants of unknown significance (VUS). Functional assays are determinant for assessing the biological impact of these variants both at the RNA- and the protein-level. Although appropriate RNA analyses are essential to help determining the relevance of VUS, standard operating procedures are lacking. The aim of this study was to define critical points for the experimental evaluation of the impact of VUS on RNA splicing and to optimize the protocols for cDNA analyses in MMR genes.

A collaborative study involving three different laboratories of the European MMR Working Group was initiated. Splicing analysis of seven VUS (*MLH1* c.1039-2A>T, c.1217G>A, c.1989+4_1989+5insC; *MSH2* c.211G>C, c.1276G>A, c.2459-12A>G; *MSH6* c.1894A>G) was performed using different strategies based on RT-PCR: (i) long-range RT-PCR of endogenous RefSeq MMR transcripts, (ii) short RT-PCR of the region of interest, (iii) ex-vivo minigene assays. Patients' RNA was obtained from blood samples collected into PAXgene tubes or from lymphocytes cultured for a short-term in presence/absence of puromycin. The presence of aberrant transcripts was evaluated, and results were compared.

Our data indicates that RNA quality and PCR primer design are essential for obtaining interpretable and comprehensive results, and that RNA from short-term lymphocyte cultures yielded better results than from PAXgene. Five of the seven variants analyzed affected RNA splicing. Long-range PCR analysis detected more aberrant transcripts than short RT-PCR and minigene strategies for two variants and allowed a more significant classification for variants located *in-trans*. Minigene assays are very sensitive in detecting aberrant transcripts within a region of interest. This approach is particularly useful for pinpointing intronic splicing mutations in the absence of exonic tracers.

The data generated by this work is important for the interpretation/classification of the seven studied MMR VUS. Long-range PCR cDNA analysis of the complete transcript is recommended for the splicing analysis of MMR gene variants. Short RT-PCR and minigene strategies are recommended for validation using an independent strategy. The proposed optimized protocol for MMR gene splicing analysis improves the robustness of the assay, critical for the clinical interpretation of VUS.

PP222 - POLYMERASE PROOFREADING-ASSOCIATED POLYPOSIS (PPAP) AND LYNCH SYNDROME: NOVEL AND PREVIOUSLY REPORTED VARIANTS IN POLE AND POLD1 EXONUCLEASE DOMAIN AND COMBINED PMS2 AND POLE GERMLINE VARIANTS IN A PATIENT WITH EARLY ONSET COLORECTAL CANCERS

M. Calicchia¹, N. Musso², G. Cinnirella², L. Reggiani Bonetti³, S. D'Innocenzo¹, M. Ciavarella⁴, B. Riboli⁵, P. Cavalli⁵, M. Castori⁶, P. Grammatico⁶, L. Candita⁷, R. Tricarico⁸, V. Barresi², D. F. Condorelli², M. Genuardi⁹, E. Lucci-Cordisco¹

¹Istituto di Medicina Genomica, Università Cattolica del Sacro Cuore Roma, ²Dipartimento di Scienze Biomediche e Biotecnologiche - Sezione di Biochimica Medica - Università di Catania Catania, ³Dipartimento di Medicina di Laboratorio e Anatomia Patologica, Università di Modena e Reggio Emilia; sezione di Anatomia e Istologia Patologica Modena, ⁴SSD Unità Tumori Ereditari e Endocrinologia Oncologica - Istituto Oncologico Veneto I.R.C.C.S. Padova, ⁵Unità di Genetica Medica - Azienda Istituti Ospitalieri Cremona, ⁶Unità di Genetica Medica, Ospedale San Camillo-Forlanini Roma, ⁷Genetica Medica, Dipartimento di Scienze Biomediche, Sperimentali e Cliniche, Università di Firenze Firenze, ⁸Cancer Epigenetics and Cancer Biology Program, Fox Chase Cancer Center Philadelphia, ⁹Istituto di Medicina Genomica, Università Cattolica del Sacro Cuore - UOC Genetica Medica, Fondazione Policlinico "A. Gemelli" Roma

Polymerase Proofreading-Associated Polyposis (PPAP) is an autosomal dominant (AD) condition recently described in patients with multiple colonic adenomas (MCA) and colorectal cancer (CRC), accounting for <1% of all CRC cases. This AD inherited cancer predisposition is due to constitutional variants of the *POLE* or *POLD1* genes exonuclease domain (aa 278-471 and 304-517, respectively). Phenotype and prevalence of this condition are not well defined. Some patients with PPAP fit the clinical criteria for Lynch Syndrome.

We have investigated genomic DNA from 190 patients with MCA (>10), early onset CRC (EA-CRC) and/or familial CRC for mutations in the *POLE* and *POLD1* proofreading domains by either Sanger or Next Generation Sequencing (NGS). The significance of the identified variants was assessed with the in silico tools Polyphen2, SIFT, Mutation Taster, ClustalOmega, Phyre2 and PyMol.

Five *POLE* variants (p.Asp392Gly, p.Lys425Arg, p.Leu424Val, p.Ser459Cys, p.Pro436Ser) and two *POLD1* variants (p.Lys439Asn, p.Arg331Trp) were identified.

Two *POLE* variants p.(Asp392Gly) and p.(Lys425Arg) co-occurred in a patient with early onset CRC (age 37 years), followed by two metachronous CRCs and a positive family history. The same patient also harboured the *PMS2* mismatch repair gene pathogenic variant p.Arg287fs. Immunohistochemical analysis of MMR proteins showed isolated lack of expression of PMS2 in tumor tissue. Analysis of a panel of cancer related genes in tumor tissue revealed a hypermutated phenotype.

To our knowledge, co-inheritance of variants associated with PPAP and Lynch Syndrome in the same individual has, so far, never been observed. Our findings contribute to a better definition of the phenotype and mutation spectrum of PPAP caused by *POLE/POLD1* defects, also suggesting that the phenotype can be influenced by the presence of variants in other cancer predisposing genes.

PP223 - AN INTERDISCIPLINARY MODEL FOR GASTROINTESTINAL HEREDITARY SYNDROMES SUPPORTED BY NEXT GENERATION SEQUENCING TECHNOLOGY

P. Carrera¹, S. Merella², I. Spiga³, S. Calzavara³, S. Presi³, M. G. Patricelli⁴, A. Russo Raucci⁴, F. Calabrese⁵, A. Mannucci⁵, R. Rosati⁵, M. Reni⁵, M. Ronzoni⁵, P. A. Testoni⁵, M. Ferrari⁶, G. M. Cavestro⁷

¹Division of Genetics and Cell Biology, Unit of Genomics for Human Disease Diagnosis and Laboratory of Clinical Molecular Biology, IRCCS San Raffaele Scientific Institute, Milan, ²Laboratory of Clinical Molecular Biology and Centre for Translational Genomics and Bioinformatics, IRCCS San Raffaele Scientific Institute, Milan, ³Laboratory of Clinical Molecular Biology, IRCCS San Raffaele Scientific Institute Milan, ⁴Clinical Genetics, IRCCS San Raffaele Scientific Institute Milan, ⁵Gastroenterology and Gastrointestinal Endoscopy Unit, Vita Salute San Raffaele University, IRCCS Ospedale San Raffaele, Milan Milan, ⁶Vita-Salute San Raffaele University, chair of Clinical Pathology, Milan Milan, ⁷Gastroenterology and Gastrointestinal Endoscopy Unit, Vita Salute San Raffaele University, IRCCS Ospedale San Raffaele Milan

Background. A germline mutation has been advocated in up to 10% of patients diagnosed with gastrointestinal cancers, but syndromic patients and their relatives are not always correctly identified in clinical practice. We attempted an interdisciplinary clinical unit (gastroenterologists, geneticists, surgeons, oncologists and pathologists) to improve diagnosis and management of high-risk families for syndromic colorectal, gastric and pancreatic cancer.

Patients and methods. Patients are asked about personal and family history with relevance to cancer diagnosis before the age of 50 and number of relatives affected (at least two first-degree). Accepted clinical criteria (Kastrinos' questions, PREMM1,2,6 Model for Lynch Syndrome, ACG Guidelines for gastric and pancreatic hereditary cancer) are used to calculate who might benefit from genetic testing through NGS Panel. Before any clinical application, a validation test had been conducted for the Illumina® TruSightCancer panel, to define sensitivity and specificity. Analysis of sequencing data was performed with our bioinformatic pipeline (100% sensitivity, >94% specificity) based on the BWA, GATK, HaplotypeCaller, freebayes, and MiSeq Reporter tools. Panel validation was performed on 21 DNA samples previously analysed by Sanger direct sequencing, in genes associated with hereditary cancers.

Results. 188 patients have been referred to our outpatient unit between Sept 2015 and Oct 2016. 120 patients did not meet inclusion criteria and were considered in the average risk population. Among the selected 68 high-risk patients for syndromic cancer, 12 had already had a previous genetic diagnosis of hereditary condition in the family: they were assigned to the surveillance program according to current guidelines. The remaining 56 were proposed for NGS test. 9 declined. In 8 out of the 47 patients who underwent NGS, we found a total of 9 pathogenic variants in the following genes: APC (2), MUTYH (2), MSH2 (2), MSH6 (2), PRSS1 (1). A total of 24 variants of uncertain significance (VUS) have been identified.

Conclusion. An interdisciplinary approach to hereditary cancer syndromes allow for a more accurate identification of high-risk mutation carriers. Clinical criteria used in combination with NGS analysis look promising in both a clinical and research setting. This integrated approach has been able to confirm the diagnosis of a hereditary form of cancer in 17% (8/47) of cases in our cohort, while in 34% (17/47) we found a VUS.

PP227 - MUTATIONAL SPECTRUM OF 35 LYNCH SYNDROME ARGENTINEAN FAMILIES: MORE TO SAY ABOUT LYNCH SYNDROME IN SOUTH AMERICA

M. Antelo¹, M. Golubicki², D. Milito¹, S. M. Hirmas², L. Pepe³, M. Carballido¹, G. Mendez¹, S. Iseas¹, M. Barugel¹, M. A. Bartellini⁴, A. Cabanne³, D. Cisterna², R. Enrique¹

¹Oncology Section, Hospital of Gastroenterology "Dr.C.B. Udaondo" Buenos Aires, ²Biology Molecular Laboratory, Hospital of Gastroenterology "Dr.C.B. Udaondo" Buenos Aires, ³Pathology Section, Hospital of Gastroenterology "Dr.C.B. Udaondo" Buenos Aires, ⁴Central Laboratory, Hospital of Gastroenterology "Dr.C.B. Udaondo" Buenos Aires

Introduction: although only a minority of the total cases, Lynch syndrome (LS) represents around 150 cases of colorectal cancer (CRC) per year in Argentina. Nevertheless, we still lack a unified Argentinean Registry of Hereditary Colorectal Cancer. Recently published data about LS in South America revealed 128 mismatch repair genes (MMRg) variants in 243 South American families with suspected LS, being 98 classified as deleterious. Of these, 48 families were Argentinean. We here report the mutational spectrum of 31 additional MMRg variants in 35 families of our Registry, located in the Hospital of Gastroenterology "Dr. C. B. Udaondo", a public metropolitan hospital in Buenos Aires, Argentina. **Methods:** MMR status of families with Amsterdam criteria and/or Bethesda guidelines registered in our Hospital was assessed, and those with MMR deficiency were followed by direct sequencing +/- Multiplex ligation-dependent probe amplification (MLPA) of MMRg. Those with deleterious variants in a MMRg were classified as LS. Mutation nomenclature was in accordance with the Human Genome Variation Society guidelines. **Results:** in total, 35 families harbored 31 MMRg variants that we classified as LS: 52% affected MLH1, 36% affected MSH2, 10% affected PMS2 and 2% MSH6. Missense and frameshift mutations were the most common alterations (35 % and 26%, respectively), followed by nonsense mutations (19%), splice site mutations (10%), large deletions (6%), and inframe deletions (4%). Of the 31 disease predisposing MMRg mutations, 18 (58%) were reported in the InSIGHT variant classifications database (IVCD). Of these 18, 15 were classified as LS predisposing variants, 2 were classified as variant of uncertain significance (VUS) (1 of which was predicted pathogenic by the *in silico* analysis with Mutation Taster-ISAMT-, and the other one was predicted as a polymorphism, but it was present in a patient with CRC, pancreas and prostate cancer who belonged to a family with Amsterdam II criteria). The last variant was classified as not pathogenic, but it was associated with LS in several reports, it was predicted as pathogenic with ISAMT, and it was highly suspicious of LS fulfilling Bethesda 1, 2, 3 and 4 criteria. The remaining 13 (42%) identified MMRg variants were classified as VUS because they are not reported in the IVCD, but we considered them as disease-predisposing since 2 were large deletions and the remaining 11 were all predicted pathogenic by ISAMT and not present in two control population databases (Exome Aggregation Consortium and Exome Variant Server). **Conclusions:** lining up with the last report in 2016 of LS in South America, we believe that our data represents valuable information to continue deepening the genetic CRC profile of our understudied population, with a mixed and intriguing ancestry.

PP228 - DESCRIPTIVE ANALYSES OF MMR GENE MUTATION CARRIERS AT A SINGLE INSTITUTION IN BRAZIL

H. Galvao¹, A. de Paula², C. Sabato², G. Fernandes², M. Cadamuro Neto³, L. G. Romagnolo³, C. E. Andrade⁴, R. Reis⁵, E. Palmero²
¹Oncogenetics Department Barretos, ²Pathology Department Barretos, ³Gastrointestinal Department Barretos, ⁴Gynecology Department Barretos, ⁵Molecular Oncology Barretos

Up to 5% of colorectal cancer (CRC) and 2% of endometrial cancer (EC) cases are related to Lynch syndrome (LS), caused mainly by mutations in the mismatch repair (MMR) genes. At Hospital de Câncer de Barretos (HCB), patients who meet criteria are referred to Oncogenetics Department for genetic counseling. Objective: To describe clinical presentation and management of LS carriers from HCB. Methodology: Retrospective case series report reviewed from family records, between April/2010 and December/2016. Surveillance was performed according to NCCN guidelines. Results: We have evaluated 190 individuals who tested positive, from 62 families (38.7% *MLH1*, 37.1% *MSH2*, 16.2% *MSH6* and 8% *PMS2*). Epidemiological and clinical presentation are shown in table 1 and table 2 (for details, see subtitles)

TABLE 1 - Probands and relatives clinical presentation

	N	Median age at post-test GC	Gender (% female)	CRC (median age ^a)	EC	gastric cancer	ovarian cancer	urothelial carcinoma	skin sebaceous carcinoma	duodenal carcinoma	prostate cancer
Probands ^b	62	51y	56.5%	51 (46y)	17 (49y)	4 (53y)	3 (40y)	1	1	0	1
Relatives ^c	128	41y	58.6%	-	-	-	-	-	-	-	-
diagnostic test	23	57y	60.1%	12 (45y)	6 (40y)	0	0	3	1	0	2
predictive test	105	37y	58.1%	4	0	0	0	0	0	1	0

detected among unrelated families were: *MLH1* c.1276C>T (9.7% of the families), *MLH1* deletion between exons 17 and 19 (4.8%), *MSH2* c.174dupC, *MSH6* c.151dupA, *PMS2* (3.2% of the families, each).

Conclusions: Since we have the opportunity to test the relatives, effort should be done to enroll them in this program. LS phenotype in our patients was similar to what is described in current germline mutations are diverse among Brazilian LS patients. More time and deeper analysis are necessary to estimate extension and cost-efficiency of this program.

GC: Genetic counseling. ¹When available, median age at cancer diagnosis is in parenthesis. ²All 62 probands had at least one previous diagnosis of cancer. ³Among the 128 relatives that tested positive, 23 already had a previous cancer diagnosed. In 105 asymptomatic carriers (individuals with a positive predictive test, five cases of malignant neoplasia were detected during a median surveillance period of 19 months).

¹ Each primary carcinoma detected in an individual was reported separately.

The recurrent mutations c.2185_2186delCT

literature. MMR gene

TABLE 2 - Types of neoplasia seen in carriers of each MMR gene mutated

Gene	mutation carriers with cancer	CRC ¹	EC ¹	gastric cancer ¹	ovarian cancer ¹	urothelial carcinoma ¹	other types	TOTAL
<i>MLH1</i>	45	38	5	2	1	1	10	57
<i>MSH2</i>	33	25	12	2	2	2	2	45
<i>MSH6</i>	12	9	5	0	0	1	1	16
<i>PMS2</i>	5	4	1	0	0	0	0	5
TOTAL	95	76	23	4	3	4	13	123

Conclusions: Since we have the opportunity to test the relatives, effort should be done to enroll them in this program. LS phenotype in our patients was similar to what is described in current literature. MMR gene germline mutations are diverse among Brazilian LS patients. More time and deeper analysis are necessary to estimate extension and cost-efficiency of this program.

PP229 - DEFINING NEW COLORECTAL CANCER SYNDROMES IN A POPULATION BASED COHORT

A. Keränen¹, A. Forsberg², S. Ghazi¹, N. Papadogiannakis¹, A. Lindblom¹

¹Laboratory Medicine, Karolinska Institute Stockholm, ²Molecular Medicine and Surgery, Karolinska Institute Stockholm

Background:

We have collected 3000 consecutive colorectal cancer cases and taken a full family history of cancer for all (1,2). We aimed to verify all diagnoses, which could relate to gastrointestinal tumors, thus any kind of tumor in the abdomen. Other tumors, such as breast-, prostate- or hematological malignancies were not verified using medical records.

Aims:

We wanted to use this material to search for novel syndromes involving CRC.

Methods:

We studied this by comparing the number of cancer types in families with at least two close family members with CRC to the number of tumors in all the other families. The search was limited to first- and second-degree relatives and cousins. FAP and Lynch syndrome were excluded. Detailed morphologic data was available for the tumours.

Results:

There were significantly more other cancers in the CRC families compared to those with only a single case of CRC. In particular, gastric cancer and prostate cancer were among the most common cancers, suggesting that in some families various forms of cancer segregate as a dominant cancer predisposing trait. Figures for rare cancers were not often significant. There was some support for different morphologic profiles for four of the five tested syndromes.

PP230 - UNIVERSAL SCREENING FOR LYNCH SYNDROME IN PATIENTS WITH ENDOMETRIAL CANCER

C. K. Lautrup¹, H. Okkels², C. H. SÃ,gaard³, E. SÃ,gaard-Andersen³, A. Grove⁴

¹Department of Clinical Genetics, Aalborg University Hospital Aalborg, ²Section of Molecular Diagnostics, Clinical Biochemistry, Aalborg University Hospital Aalborg, ³Department of Gynecology, Aalborg University Hospital Aalborg, ⁴Institute of Pathology, Aalborg University Hospital Aalborg

Introduction

After colorectal cancer, endometrial cancer (EC) is the second most prevalent cancer in Lynch syndrome, and EC is the first cancer in approximately 50% of women with Lynch syndrome. Traditionally, criteria based on family history have been used to identify families with Lynch syndrome. This strategy is less efficient nowadays, since family size is decreasing. We present a study with consecutive screening for Lynch syndrome using immunohistochemistry (IHC) of the mismatch-repair (MMR) proteins in patients diagnosed with EC.

Material and Methods

All incident endometrial carcinoma and carcinosarcoma cases in the Northern Region of Denmark diagnosed between June 2013 and May 2016 were screened with IHC of the four MMR proteins pMLH1, pMSH2, pMSH6, and pPMS2. Tumors with loss of pMLH1/pPMS2 were further analysed with methylation analysis of the *MLH1* promotor region. Patients with loss of pMLH1/pPMS2 and no *MLH1* promotor methylation, loss of pMSH2/pMSH6, or isolated loss of one MMR protein were offered Sanger Sequencing of the MMR genes.

Results

Out of 246 EC patients, IHC revealed 65 patients with loss of MMR proteins. 46 patients had loss of pMLH1/pPMS2 and *MLH1* promotor methylation. Nineteen patients were offered genetic counselling. Sequencing of the MMR genes in 11 of these patients revealed six patients with a pathogenic variant (one *MSH2* and five *MSH6*) and one patient with a variant of unknown significance in *PMS2*. In 4 patients no pathogenic variant were found.

Conclusion

Lynch syndrome was identified in 2.4% of the EC patients. In most cases (83%) a pathogenic variant in *MSH6* was found. None of the patients with *MSH6* mutations would have been diagnosed with Lynch syndrome if only family based criteria had been used. Universal screening with IHC of the MMR proteins seems as relevant in patients diagnosed with EC as it is in colorectal cancer cases.

PP232 - ANALYSIS OF THE VARIANT *MLH1* c.588+5G>C IN BRAZILIAN PATIENTS WITH LYNCH SYNDROME: IS THIS REALLY A VUS?

I. L. de Oliveira Nascimento¹, J. Cortes de Freitas², P. Carãzo Oliveira², J. Goes Castro Meira³, G. Espirito Santo Felix², T. M. Machado Lopes², T. Ferreira Bomfim², R. Meyer⁴, M. B. Pereira Toralles⁵, K. Abe-Sandes²

¹Nucleo de Oncologia da Bahia Salvador, ²Instituto de Ciãncias da Saãde de Salvador, ³Universidade do Estado da Bahia Salvador, ⁴Instituto de Ciãncias da Saãde sal, ⁵Complex Hospitalar Universitãrio Prof. Edgard Santos (HUPES) Salvador

About 6% of colorectal cancer (CRC) cases are associated with hereditary syndromes with predisposition to cancer, among them the most common is Hereditary Nonpolyposis Colorectal cancer (HNPCC), known as Lynch syndrome (LS). The HNPCC is an autosomal dominant condition associated to mutations mainly in *MSH2*, *MSH6*, *MLH1*, *PMS1* and *PMS2* genes. Mutations in these genes increase predisposition to develop CRC. The *MLH1* c.588+5G>C (rs267607768) variant was classified by Insight Consortium as variant of uncertain significance (VUS), though Petersen et al., 2013 analyzed another variant at the same position, guanine (G) to adenine (A), and classified it as pathogenic. Here the *MLH1* c.588+5G>C variant was detected by Sanger sequencing in three unrelated cases from State of Bahia, Northeast of Brazil, with clinical criteria and familial history of HNPCC. We aim to verify the segregation of this variant with the disease in the proband's unaffected (3) and affected (6) relatives, besides 80 controls (cancer free unrelated males and females). All patients met the Amsterdam II criteria and presented absence of *MLH1* expression in the immunohistochemical (HI) analysis. The mean age at diagnostic of the probands was 51.6 yrs, while among affected relatives 55 yrs and unaffected relatives 23 yrs, and controls 54.16 yrs. The *MLH1* c.588+5G>C was identified in all cases and one 19 years old unaffected (1.205), $P < 0.0001$. Although, this variant is located at an intron splicing region, the Genomic Evolutionary Rate Profiling (GERP) NR score was high (5.62), indicating that this genomic region is greatly constrained. Also, the ExAC's pLI score is close to 1 (0.7396), showing that this change is intolerant of both heterozygous and homozygous loss-of-function variants, then disease causing. Therefore, these findings suggest that this variant is pathogenic and has a founder effect in this region of Brazil due to its high frequency.

PP235 - COMPREHENSIVE VARIANT ANALYSES INCLUDING WHOLE GENOME SEQUENCING IN HEREDITARY COLORECTAL CANCER SYNDROMES

A. Rohlin¹, A. Kvist², T. Törnngren², F. Eiengård¹, U. Lundstam³, T. Zagoras¹, Å.... Borg², J. Björk⁴, M. Nordling¹

¹Department of Clinical Pathology and Genetics Göteborg, ²Department of Clinical Sciences Lund Lund, ³Department of Surgery, Sahlgrenska Academy at University of Gothenburg Göteborg, ⁴The Swedish Polyposis Registry, Department of Medicine, Karolinska Institute Stockholm

High penetrant pathogenic variants in known hereditary colorectal cancer (CRC) predisposition genes explain 5-10% of cases. Clinical testing in hereditary CRC syndromes is usually performed based on phenotype of the different syndromes. However, overlapping phenotypes between CRC syndromes, including both polyposis and non-polyposis present diagnostic difficulties in the clinic. It is crucial that the patient get a correct molecular diagnosis that allows for adequate follow-up since the majority of the syndromes include predisposition for tumors also in other organs.

Analyses of SNPs, indels and CNVs were previously performed on approximately 100 individuals divided into clinical subtypes based on phenotype. The patients were analyzed for pathogenic variants using a panel consisting of 19 high-risk CRC susceptibility genes including whole gene regions (1). In patients diagnosed with classical FAP, attenuated FAP, atypical FAP and non-polyposis subgroups, we identified pathogenic variants in *BMPRIA* and *SMAD4*. We also detected novel CNVs in upstream regions of *SMAD4*, *MSH3*, *CTNNB1* and one deletion in an intronic region of *CDHI*(1). Twenty-six of these patients have now been analyzed with whole genome sequencing (WGS). By using WGS novel SNPs, indels and CNVs were detected. One CNV was a novel complex CNV of the *SHROOM2* gene.

Using a comprehensive CRC gene panel we obtained increased detection frequency of pathogenic variants for CRC syndromes, which enable appropriate follow up of patients based on the clinical feature of each syndrome. Analysis by WGS identified additional variants and complex structural rearrangements.

1) [Rohlin A](#), [Rambech E](#), [Kvist A](#), [Törnngren T](#), [Eiengård F](#), [Lundstam U](#), [Zagoras T](#), [Gebre-Medhin S](#), [Borg Å](#), [Björk J](#), [Nilbert M](#) and [Nordling M](#). "Expanding the genotype-phenotype spectrum in hereditary colorectal cancer by gene panel testing", *Fam Cancer*, 2016, Sep 30 (Epub ahead of print)

PP236 - INTERVAL AND SCREEN DETECTED GASTRO ESOPHAGEAL AND COLON CANCER AMONG LYNCH SYNDROME PATIENTS WITH A VERIFIED MUTATION

J. E. Ollech¹, I. Barnes Kedar², A. Vilkin¹, Y. Goldberg¹, Z. Levi¹

¹Gastroenterology Petach Tikva, Israel, ²Genetics Petach Tikva, Israel

Background –Lynch syndrome patients are advised to undergo intensive surveillance, yet, data is limited regarding the yield of annual colonoscopy and upper endoscopy.

Methods – Retrospective analysis of genetically verified Lynch Syndrome subjects that underwent intensive endoscopic surveillance from 2010 to 2015 with high resolution endoscopy.

Results – Six out of 75 subjects (8.0%) under intensive surveillance had interval/screen detected cancer .Five subjects had interval colon cancer, the interval time was 12 month in 4 subjects and 16 months in 1 case; four of them had stage I cancer and 1 subject had stage II cancer. Two subjects had gastric cancer: one subject had interval gastric cancer 12 months from previous EGD (this subject had also interval colon cancer) and one subject had screen detected stage I gastric cancer on her first EGD after the mutation was detected. None had a family history of gastric cancer. Four out of the five patients with interval colon cancer had previous segmental resection for colon cancer. Previous Lynch related cancer was significantly associated with interval colon cancer (p=0.027) .

Conclusions: Lynch syndrome subjects that had one or more Lynch related cancers are at increased risk for interval cancer. Our finding also provides evidence that favors upper endoscopy even in patients without a family history of gastric cancer.

PP237 - WHOLE-EXOME SEQUENCING OF SIX RELATIVES WITH SERRATED POLYPOSIS

Y. van Herwaarden¹, R. Weren², M. Kets², E. Kamping², P. Dura¹, M. Voorendt², F. Nagengast¹, M. Ligtenberg², I. Nagtegaal³, T. Bisseling¹, N. Hoogerbrugge², R. Kuiper²

¹Department of Gastroenterology and Hepatology Nijmegen, ²Department of Human Genetics Nijmegen, ³Department of Pathology Nijmegen

Background Serrated polyposis syndrome (SPS), the development of multiple serrated polyps in the colorectum, is suspected to be a heritable syndrome, but germline aberrations predisposing to SPS still remain to be discovered. Identification of germline aberrations underlying this phenotype is important for clinical management since SPS patients and their first degree relatives are at high risk to develop colorectal cancer.

Aim We aim to discover the germline genetic aberration in a large family with multiple families affected with a serrated polyposis phenotype.

Methods We applied whole-exome sequencing (WES) on germline DNA of six affected family members with serrated polyps from two generations. We screened for pathogenic germline variants in genes previously associated with multiple serrated polyps¹. Additionally, we focused on all rare (minor allele frequency (MAF) <0.01) germline variants (including copy number variants) shared between the six affected family members.

Results We encountered truncating variants in two previously described genes; one nonsense variant (p.E49*) in *PIF1* and one deletion affecting the canonical splice site of *RBL1*. Both variants did not co-segregate with the development of serrated polyps in the family and the variant in *PIF1* was frequently encountered in our control dataset ($n=2,329$; MAF 0.0167). Thirty variants were shared between all six exomes of which twenty-nine were excluded because of a high MAF (>0,01) in 3 control databases ($n=16$) or because they did not co-segregate with the polyposis phenotype in the family ($n=13$). One missense variant (p.E333K) in the *BCAT1* gene remained, but was predicted to be benign based on five in silico prediction tools.

Conclusions We present a large family with multiple families members affected with a serrated polyposis phenotype. A causative genetic germline aberration was not found using our WES-based approach in this promising family. We anticipate that the causative genetic aberration in this family may be located outside the currently analyzed protein-coding region and, therefore, that the application of other genomic approaches, such as whole-genome sequencing, is warranted.

References

1. Gala et al. Gastroenterology, 2014;146(2):520-9

PP238 - PREVALENCE OF ESOPHAGEAL REFLUX DISEASE AND INTERVAL ESOPHAGEAL SQUAMOUS CELL CANCER IN FANCONI ANEMIA PATIENTS PARTICIPATING IN AN ACTIVE SURVEILLANCE PROGRAM

D. Itskoviz¹, H. Tamary², Y. Goldberg³, N. Sahar¹, N. Zevit⁴, Y. Leibovici Wiseman¹, O. Ben Basat¹, Z. Levi¹

¹Gastroenterology Petach Tikva, Israel, ²Hematology Petach Tikva, Israel, ³Genetics Petach Tikva, Israel, ⁴Pediatric Gastroenterology Petach Tikva, Israel

Background and aims

The primary clinical features of Fanconi anemia (FA) include typical physical features, progressive bone marrow failure and an increased incidence of neoplasms, including esophageal carcinoma. Currently, there is no data regarding endoscopic findings or the interval time to malignancy in these subjects. Our objective is to document the upper gastrointestinal (GI) findings and interval time to cancer in FA patients, undergoing active GI surveillance.

Methods

In a 9-year follow up period, 8 FA subjects were referred for endoscopic surveillance at our clinic. All subjects underwent upper endoscopies, (median endoscopies number: 5.5, range 2-14; median time of follow-up: 4.5 years, range 1-9 years). A chart review was performed and pathology slides were examined.

Results

All subjects (100%) had an endoscopic evidence of reflux esophagitis: 3 (37.5%) had mild and 5 (62.5%) had moderate-severe reflux esophagitis. Three subjects (37.5%) had complicated esophageal reflux disease (two subjects developed Barret's esophagus and one subject had an esophageal stricture). Eventually, two subjects (25 %) developed esophageal squamous cell carcinoma during follow up, with interval time of 8 and 18 months from previous upper endoscopy.

Conclusions

FA subjects have an extremely high frequency of esophageal reflux disease. They appear to be prone to develop Barret's esophagus, esophageal strictures and esophageal carcinoma at short intervals. Active surveillance programs in specialized centers should be considered in these patients.

PP240 - ANTICIPATION IN SWEDISH LYNCH SYNDROME FAMILIES

J. von Salam¹, P. Boonstra², M. Karimi³, C. Aravides⁴, S. Gebre-Medhin⁵, G. Silander⁶, M. Stenmark-Askalm⁵, M. Nilbert⁷, A. Lindblom¹, K. Lagerstedt-Robinson¹

¹Department of Molecular Medicine and Surgery, Karolinska Institutet Stockholm, ²Department of Biostatistics, University of Michigan Ann Arbor, ³Department of Oncology-Pathology, Karolinska University Hospital Stockholm, ⁴Department of Immunology, Genetics and Pathology, Uppsala University Uppsala, ⁵Department of Laboratory Medicine, Lund University Lund, ⁶Department of Radiation Sciences, Umeå University Umeå, ⁷Department of Clinical Sciences, Lund University Lund

Among hereditary colorectal cancer predisposing syndromes Lynch syndrome (LS), caused by mutations in DNA mismatch repair genes MLH1, MSH2, MSH6 or PMS2, is the most common. Patients have an increased risk of early onset colorectal and endometrial cancer, but also tumors in the stomach, ovaries, small bowel, upper urologic tract and brain. However, age at onset varies within families and genetic anticipation, i.e. decreasing age at onset in successive generations, has been suggested in LS. Anticipation have been reported in heritable cancers such as familial melanoma, pancreatic and breast cancer. The purpose of this study was to determine whether anticipation can be shown in a large cohort of Swedish LS families.

We have analyzed a homogenous group of known mutation carriers, utilizing information from both affected and non-affected family members. In total, 239 families with a mismatch repair gene mutation (96 MLH1 families, 90 MSH2 families including one family with an EPCAM deletion, 39 MSH6 families, 12 PMS2 families, and 2 MLH1+PMS2 families) comprising 1028 at-risk carriers were identified, of which 1003 could be included in the study.

Using a normal random effects model (NREM) we estimate a 2.1 year decrease in age of diagnosis per generation. An alternative analysis using a mixed-effects Cox proportional hazards model (COX-R) estimates a hazard ratio for age of diagnosis between consecutive generations of $\exp(0.171)$, or about 1.19. LS-associated gene-specific anticipation effects are highly significant for MSH2 (2.5 years/generation for NREM and hazard ratio of 1.33 for COX-R) and PMS2 (7.3 years/generation and hazard ratio of 1.85).

Our objective to study if anticipation is part of the clinical picture in Swedish families with LS has the long term goal to enable better prediction of age at onset in family members. While the evidence is more equivocal for MLH1 and MSH6, our results indicate anticipation in families with mutation in MSH2 and PMS2 suggesting gene-specific dynamics influencing age at cancer onset. This points to the importance of understanding the disease mechanisms in carriers of different mutations and at what age surveillance should be initiated.

PP241 - WHAT IS THE BENEFIT OF EXTENDING IHC PRE SCREEN FOR ALL PATIENTS UP TO 60 YEARS OF AGE TO DETECT PATIENTS AT RISK OF LYNCH SYNDROME?

D. Speake¹, N. Onyeador², M. Porteous², P. Fineron³, F. Din¹, M. Dunlop¹, A. Oniscu⁴

¹Department of Coloectal Surgery Western General Hospital Edinburgh, ²Clinical Genetics, Western General Hospital Edinburgh,

³Department of Histopathology, Western General Hospital Edinburgh, ⁴Department of Histopathology, Royal Infirmary Edinburgh

Introduction:

The current Royal College of Pathology UK dataset (2014) recommend Mismatch Repair (MMR) immunohistochemical (IHC) testing is considered a core item for patients under the age of 50 and in those adenocarcinomas, with morphological features of MMR deficiency. In Edinburgh this has been extended to include all patients up to and including the age of 60. The current Mallorca group guidelines recommend this be extended to the age of 70, however this is not routinely performed in the UK. Bowel cancer UK have already established that there are many units in the UK who do not offer any pre screen at all. We report outcomes from IHC pre screen from our unit in Edinburgh covering the South East of Scotland Cancer Network.

Methods:

All patient less than 60 years of age were identified through the colorectal cancer multidisciplinary meeting at the Western General Hospital in Edinburgh. This was then cross referenced with the pathology laboratory records for all patients having MMR IHC.

Results:

In total 423 patients were identified, 153 less than 50 years of age, 270 51-60 years of age. Of those patients <50 years of age 132 had positive staining and 21 (13.7%) loss of staining; 9 of these 21 patient were found to have Lynch Syndrome (LS), ie 5.9% of all patients screened in this age category. Of those patients between the age of 51 and 60 years of age 263 had positive staining and 7 (2.6%) loss of staining; 1 of these 7 patients was found to have LS ie 0.37% of all patient screened in this age category.

Discussion:

The diagnostic utility of IHC pre screen for LS is predictably higher in the <50 age range. Although extending the age from 50-60 years of age only identified 1 further patient with LS the implications for cascade screening for this pedigree and oncological implications for those individuals with methylation of MLH-1 justify the test.

PP243 - IDENTIFICATION OF FUNCTIONALLY DELETERIOUS GERMLINE GALNT12 VARIANTS IN A POPULATION-BASED COHORT OF INCIDENT COLORECTAL CANCER CASES

D. R. Evans¹, S. Venkitachalam², L. Revoredo³, A. Dohey¹, E. Clarke⁴, E. Quinn⁵, L. Ravi⁵, T. A. Gerkin⁶, J. Green⁴, M. O. Woods⁴, K. Guda⁷

¹Discipline of Genetics, Faculty of Medicine, Memorial University of Newfoundland St. John's, ²Division of General Medical Sciences-Oncology, Case Comprehensive Cancer Center, Case Western Reserve University School of Medicine Cleveland, ³Department of Chemistry, Case Western Reserve University Cleveland, ⁴Discipline of Genetics, Faculty of Medicine, Memorial University of Newfoundland St. John's, ⁵Division of General Medical Sciences-Oncology, Case Comprehensive Cancer Center, Case Western Reserve University School of Medicine Cleveland, ⁶Department of Chemistry, Department of Pediatrics, Department of Biochemistry, Case Western Reserve University School of Medicine Cleveland, ⁷Division of General Medical Sciences-Oncology, Case Comprehensive Cancer Center, Case Western Reserve University School of Medicine, Cleveland

We previously identified *GALNT12* as a candidate colorectal cancer (CRC) susceptibility gene. In order to determine the extent and significance of germline *GALNT12* defects in CRC patients, we performed targeted sequencing of this gene in a well-characterized cohort of incident CRC cases ($N=334$), from the Newfoundland Colorectal Cancer Registry. Our analysis identified 8 rare (MAF < 1%) germline variants, including 7 missense (p.H101Q, p.I142T, p.E239Q, p.T286M, p.V290F, p.R297W, p.D303N) and a putative splice-site variant (c.732-8 G>T), which were derived from nine unrelated families. Of interest, 5 out of 7 of these missense variants mapped to the glycosyl transferase domain, a region mediating the enzymatic activity of the encoded *GALNT12* protein. Further sequencing of the CRC-associated germline variants in DNA from ethnically matched population controls ($N=181$) revealed only one of the missense variants (p.D303N) present in a single control individual. Subsequent functional characterization of the *GALNT12* missense variants using *in vitro*-derived peptide substrates revealed a significant and marked loss in *GALNT12* glycosyltransferase activity for 4 of the 7 variants (p.H101Q, p.I142T, p.V290F, p.R297W), with the remaining 3 variants (p.E239Q, p.T286M, p.D303N) showing a diminished enzymatic activity. Taken together, these findings provide additional evidence supporting the contribution of genetic defects in *GALNT12* to CRC susceptibility.

PP245 - CULTURAL PERSPECTIVE ON THE MANAGEMENT OF FAMILIAL ADENOMAS POLYPOSIS IN SAUDI ARABIA; A FAMILY CASE STUDY

S. Ahmed Shire, RN, MPH¹

¹Colorectal Registrar, King Faisal Specialist Hospital & Research Centre (KFSH&RC)

Background: Familial Adenomas Polyposis (FAP) is a dominant autosomal disease characterized by the development of 100s of colon and rectal polyps in young adulthood (1,2,3). A registry is often established for patients with this inherited condition and their families with the aim of improving their prognosis through early detection and prophylactic treatment (1,3). The Hereditary Colorectal Tumor Registry (HeCTR) has been established as the first polyposis registry in Saudi Arabia at King Faisal Specialist Hospital and Research Centre (KFSH&RC) in 2008 (4).

Aim: To describe the family pedigree, phenotype, clinical management and the challenges faced in the management of Saudi average FAP families by the Hereditary Colorectal Tumor Registry.

Conclusion:

- The average Saudi family has been estimated to be around 6 members per household (5). Constructing a family pedigree in Saudi Arabia often includes challenges in the family sizes and the consanguineous marriage. Contacting and reaching at risk family members is a challenge on most occasions, not because of restrictions related to health confidentiality, but due to lack of demographic information address infrastructure and primary health care registrations.
- In spite of difficulties and challenges in reaching patients and at risk families, families are used as the main communication tool and recruiters for predictive screening and registration. More than 95% of at risk family members have been screened and have undergone prophylactic surgery. Pre-implantation genetic diagnosis (PGD) is also offered to all FAP patients free of charge to minimize the inheritance of the disease.

References: a polyposis register*

1. Bülow, S., Burn, J., Neale, K., Northover, J., Vasen, H., 1993. The establishment of a polyposis registers. *International Journal of Colorectal Disease*. 8(1), pp.34–38.
2. Tudyka, V.N. and Clark, S.K., 2012. Surgical treatment in familial adenomatous polyposis. *Annals of Gastroenterology*, 25(3), p.201.
3. Iwama, T., Tamura, K., Morita, T., Hirai, T., Hasegawa, H., Koizumi, K., Shirouzu, K., Sugihara, K., Yamamura, T., Muto, T. and Utsunomiya, J., 2004. A clinical overview of familial adenomatous polyposis derived from the database of the Polyposis Registry of Japan. *International journal of clinical oncology*, 9(4), pp.308-316.
4. Al-Sanea, N. and Hibbert, D., 2015. The Saudi Hereditary Colorectal Tumor Registry: status and challenges. *Gastrointestinal Nursing*, 13(7).
5. Salam, A.A., Elsegaey, I., Khraif, R. and Al-Mutairi, A., 2014. Population distribution and household conditions in Saudi Arabia: reflections from the 2010 Census. *SpringerPlus*, 3(1), p.53.

EARLY ONSET COLORECTAL CANCERS: CLINICOPATHOLOGICAL, MOLECULAR AND ONCOLOGICAL FEATURES

Eusebi LH¹, Artesiani ML¹, Ceccarelli C², Montanaro L³, Derenzini M³, Dall'Olio FG⁴, Ardizzoni A⁴, Biasco G⁴, Adua D⁴, Bazzoli F¹ and Ricciardiello L¹

¹ *Gastroenterology Unit, Sant'Orsola University Hospital, Bologna, Italy*

² *Pathology Unit, Sant'Orsola University Hospital, Bologna, Italy*

³ *Department of Experimental, Diagnostic and Specialty Medicine, Bologna University, Italy*

⁴ *Medical oncology Unit, Sant'Orsola University Hospital, Bologna, Italy*

Background: Up to 7% of colorectal cancers occur in patients with less than 50 years of age with no evidence of familial predisposition or belonging to hereditary syndromes (Early Onset Colorectal cancers - EOCRC). Our aim was to study a large population of EOCRC with no predisposing genetic risk factors, defining the clinicopathological and molecular features and to correlate them with the oncological outcomes.

Methods: All cases of EOCRC between 2006 and 2014 were identified from prospectively maintained databases of the oncological surgeries. Patients with hereditary nonpolyposis colon cancer, IBD, polyposis syndrome, or a known family history for these conditions were excluded.

For all included cases, data was extracted on patient demographics, clinical features, oncological treatment and postoperative follow-up. Tumours histological features and molecular data, including KRAS and BRAF genotype, MLH1 and MSH2 protein levels, as well as Ki-67, p53 and TS protein levels were also collected.

Results: Over a 10-year period, 94 cases (54% males) were identified. The mean age was 43 years. The most common site of tumour was the rectum (40%), followed by left colon (32%) and right colon (27%). 83% of patients were symptomatic at the time of diagnosis; the most common presenting symptoms were abdominal pain, haematochezia, rectal bleeding. Half of EOCRCs showed an advanced disease (34% stage III, 16% stage IV) upon presentation. Histologically, 10% of the cancers were well, 70% were moderately and 20% were poorly differentiated. Mucinous and singlet cell histology was seen in 21% and 2% cases, respectively.

Seventeen patients (22%) had a first- or second-degree relative with CRC outside of a defined syndrome (FAP or HNPCC), and 43% with any type of cancer, regardless of location.

Smoking rate in the EOCRC group was 36%, whereas 21% of patients consumed alcohol daily. The majority of patients showed a normal weight (mean BMI: 23.4).

Regarding molecular features, 7.2% and 0% showed lack of MLH1 and MSH2 expression, 37% KRAS mutation, 36% and 21% revealed low p53 and high TS levels, respectively.

The median follow-up after surgery was 35 months. The overall the 1-year survival was 91%, while at 5 years it dropped to 57%.

Conclusions: EOCRCs appear frequently as an aggressive disease located in the sigmoid colon and rectum, and most patients are symptomatic at the time of presentation. Overall prognosis of EOCRCs is poor related to the advanced stage of disease at the time of diagnosis.

REFERENCES

1. Kirzin S, Marisa L, Guimbaud R et al. Sporadic early-onset colorectal cancer is a specific sub-type of cancer: a morphological, molecular and genetics study. PLoS One 2014; 9: e103159
2. AlemánJO, EusebiLH, RicciardielloL, PatidarK, SanyalAJ, HoltPR. Mechanisms of obesity-induced gastrointestinal neoplasia. Gastroenterology 2014 Feb;146(2):357-73
3. Stigliano V, Sanchez-Mete L, Martayan A et al. Early-onset colorectal cancer: a sporadic or inherited disease? World J Gastroenterol 2014; 20: 12420-12430
4. Makhoul R, Alva S, Wilkins KB. Surveillance and Survivorship after Treatment for Colon Cancer. Clin Colon Rectal Surg 2015; 28: 262-270

EARLY ONSET COLORECTAL CANCERS VS SPORADIC COLORECTAL CANCERS: A CLINICOPATHOLOGICAL AND MOLECULAR COMPARISON

Eusebi LH¹, Artesiani ML¹, Ceccarelli C², Montanaro L³, Derenzini M³, Dall'Olio FG⁴, Ardizzoni A⁴, Biasco G⁴, Adua D⁴, Bazzoli F¹ and Ricciardiello L¹

¹ *Department of Medical and Surgical Sciences, Gastroenterology Unit, University of Bologna, Italy*

² *Pathology Unit, Sant'Orsola University Hospital, Bologna, Italy*

³ *Department of Experimental, Diagnostic and Specialty Medicine, Bologna University, Italy*

⁴ *Medical Oncology Unit, Sant'Orsola University Hospital, Bologna, Italy*

Background: Early Onset Colorectal cancers (EOCRCs) develop before the age of 50, with no evidence of familial predisposition or belonging to hereditary syndromes. Little is known about their predisposing factors and the molecular pathways that promote the early onset of these tumours. Our aim was to evaluate if EOCRCs may be defined as a distinct entity by comparing their clinicopathological, histological and molecular features to a consecutive series of sporadic CRCs developed in patients over 50 years of age.

Methods: A series of 94 EOCRC identified from prospectively maintained databases of oncological surgeries was compared to a consecutive series of 192 sporadic CRCs from patients older than 50 years (from the same hospital).

For all included cases, data was extracted on patients demographics, clinical features, and tumours histological and molecular data, including MLH1 and MSH2 protein levels, as well as p53 and Thymidylate synthase (TS) protein levels.

Results: The mean age of EOCRCs and controls was 43 and 67 years. Regarding cancer location, 57% of the control CRCs were located in the left colon, whereas the most common site of EOCRCs was the rectum ($p=0.16$). Stage II lesions were the most frequent in the controls (47% of the cases - no stage 0 or stage I cancers were present in this group) whereas the advanced stages III and IV were present in 40% and 13% of the cases, respectively. Similarly, in the EOCRCs group stage III and IV lesions represented 50% of patients, although stage IV cancers seem to occur more often (16%).

Histologically, EOCRCs showed a tendency of higher incidence of poorly differentiated tumours compared to control CRCs (20% vs. 15%) ($p=0.29$). Mucinous histology and signet-ring cell tumours were present in 15% and 0% of controls compared to 21% and 2% in the EOCRC cohort.

Regarding the molecular features, 7.2% and 0% in the EOCRC and 9.9% and 4.7% lacked MLH1 and MSH2 expression, respectively. In both groups, immunohistochemistry analysis showed similar low p53 levels in 36% of cases and high TS levels (21% in both groups).

Conclusions: The genetic basis in the majority of early onset colorectal carcinomas remains unknown, However, most EOCRCs appear to arise through the same pathways as sporadic CRCs, such as the classical adenoma-carcinoma sequence. EOCRCs appear more frequently as aggressive cancers, related to the advanced stage of disease and the delayed diagnosis since patients with less than 50 years of age are not included in screening programs.

	<i>EOCRCs (n=94)</i>	<i>Sporadic CRCs (n=192)</i>
Age, years (Average ± SD)	43.2 ± 3.9	67.3 ± 12.1
Sex		
Male	51 (54%)	107 (56%)
Female	43 (46%)	85 (44%)
Location		
Right colon	30 (32%)	83 (43%)
Left colon	64 (68%)	109 (57%)
TNM staging		
0-II	50%	47%
III-IV	50%	53%
Mismatch repair genes status		
MLH1 deficiency	7.2%	9.9%
MSH2 deficiency	0%	4.7%
p53 levels (low)	36%	36%
Thymidylate synthase levels (high)	21%	21%

Topic

Epidemiology

Title

Universal screening for Lynch syndrome among Chinese patients with colorectal cancer

Author

Ding PR¹, Jiang W¹, Li SY², Mao M², Wan DS¹, Pan ZZ¹

¹Department of Colorectal Surgery, Sun Yat-sen University Cancer Center; State Key Laboratory of Oncology in South China; Collaborative Innovation Center of Cancer Medicine, Guangzhou, PR China.

² BGI-Guangzhou Medical Laboratory, BGI-Shenzhen, PR China.

Email

dingpr@sysucc.org.cn, jiangwu@sysucc.org.cn

Conflict of interest

The authors indicated no potential conflicts of interest.

Purpose

To investigate the prevalence, genotype and optimal screening strategy of Lynch syndrome (LS) in Chinese patients with colorectal cancer (CRC).

Methods

We recruited 3330 consecutive patients who had surgical resection for newly diagnosed CRC. Immunohistochemistry for four mismatch repair (MMR) proteins was performed universally as prescreening procedure. *BRAF* mutation was tested when MLH1 protein deficiency. Germline mutation for *MMR* genes were sequenced in suspected patients.

Results

Among the 3250 patients eligible for analysis, MMR protein deficiency (dMMR) was found in 330 (10.2%) patients. Only 15(9.7%) patients with dMLH1 present with *BRAF* V600E mutation. Ninety-one patients (2.8%) were finally confirmed as LS. *MLH1*, *MSH*, *MSH6*, *PMS2*, and *EPCAM* accounted for 41.2%, 37.1%, 15.5%, 5.2%, and 1.0% of all mutations, respectively. Frameshift mutation was the most common type in *MLH1*, *MSH2* and *MSH6*, while missense variants merely appeared in *MLH1*. More than one third (36.3%) of the mutations have not been reported previously. Combined strategy of universal tumor MMR testing sequential with clinical criteria would result in 20.3% fewer cases requiring germline sequencing but only missed 6.6% cases of LS.

Conclusion

While the incidence of LS in Chinese patients is similar to that of western population, the spectrum of gene mutations and genotype seems different. Combined strategy is sensitive and cost-effective for LS screening in Chinese patients.

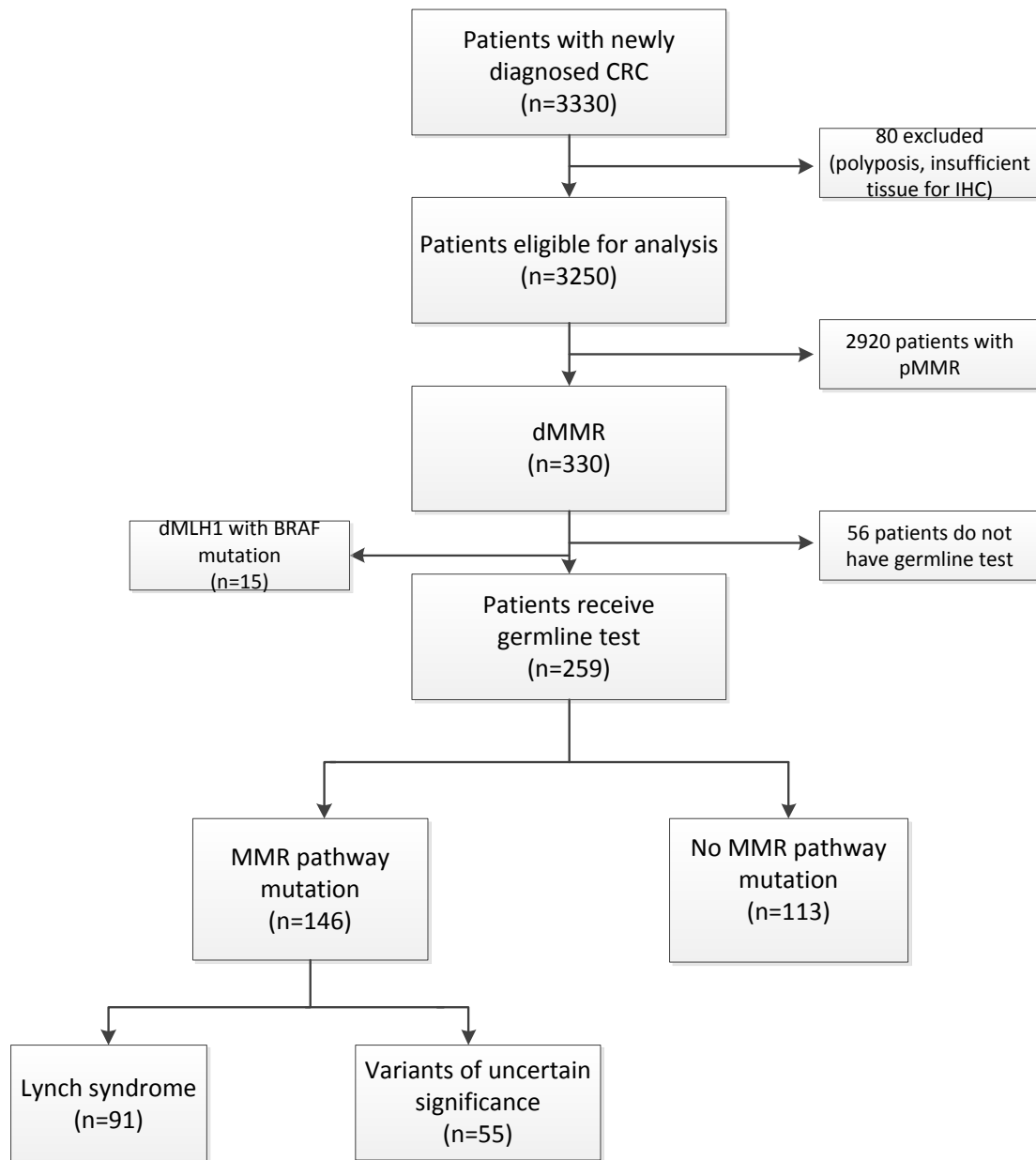

Fig.1 Flow diagram of the screening strategy and main results of the study

CRC, colorectal cancer; IHC, immunohistochemistry; MMR, mismatch repair; dMMR, mismatch repair protein deficiency; pMMR, mismatch repair protein proficiency

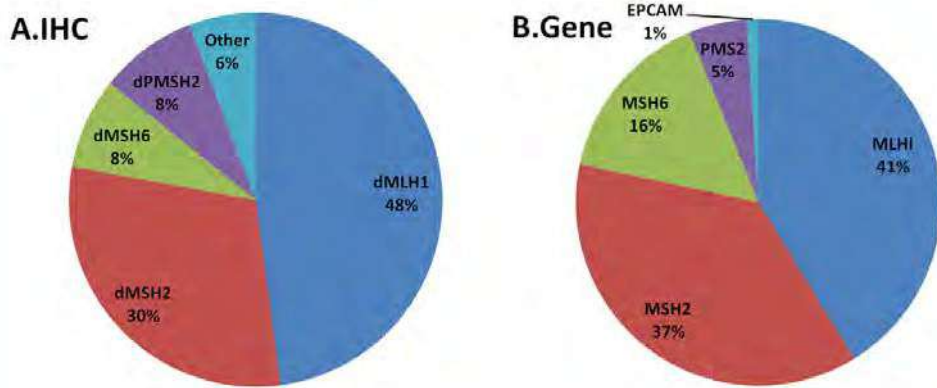

Fig.2 Schematic view of the distribution of the MMR protein deficiency(A) and germline mutations in the MMR pathway genes(B)

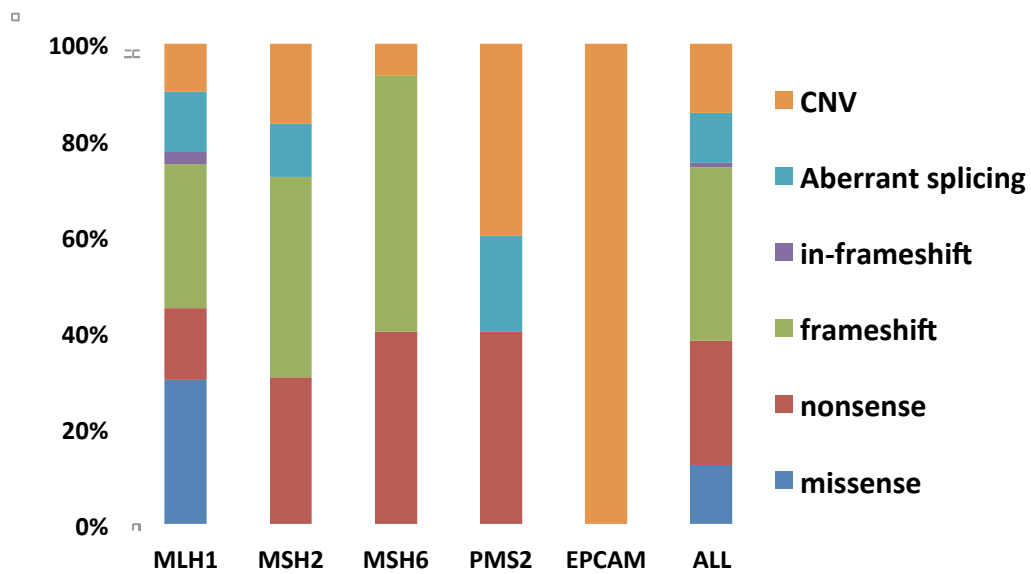

Fig.3 Percentage of different sequence variants observed in the *MLH1*, *MSH2*, *MSH6*, *PMS2* and *EPCAM* genes from a total of 97 variants.

Table1. Performance of different Strategies for the Identification of Patients with Lynch Syndrome

	Pts require MMR	Pts require sequence	True Positive	Sensitivity (%)	Specificity (%)	PPV (%)	NPV (%)	Positive Yield (%)
Amsterdam II	/	35	9	9.9	99.2	25.7	97.4	0.3
Bethesda	1045	163	73	80.2	97.1	44.8	99.4	2.3
Universal	3192	256	91	100	94.7	35.5	100	2.9
Combined*	3192	204	85	93.4	96.2	41.7	99.8	2.7

***Combined strategy:** Universal tumor MMR testing as the first line screening, then those patients with MMR protein deficiency and fulfill following clinical criteria receive germline sequencing:

- i. patients with CRC diagnosed at age ≤ 60 y
- ii. patients with CRC diagnosed > 60 y who meet the Bethesda guidelines.

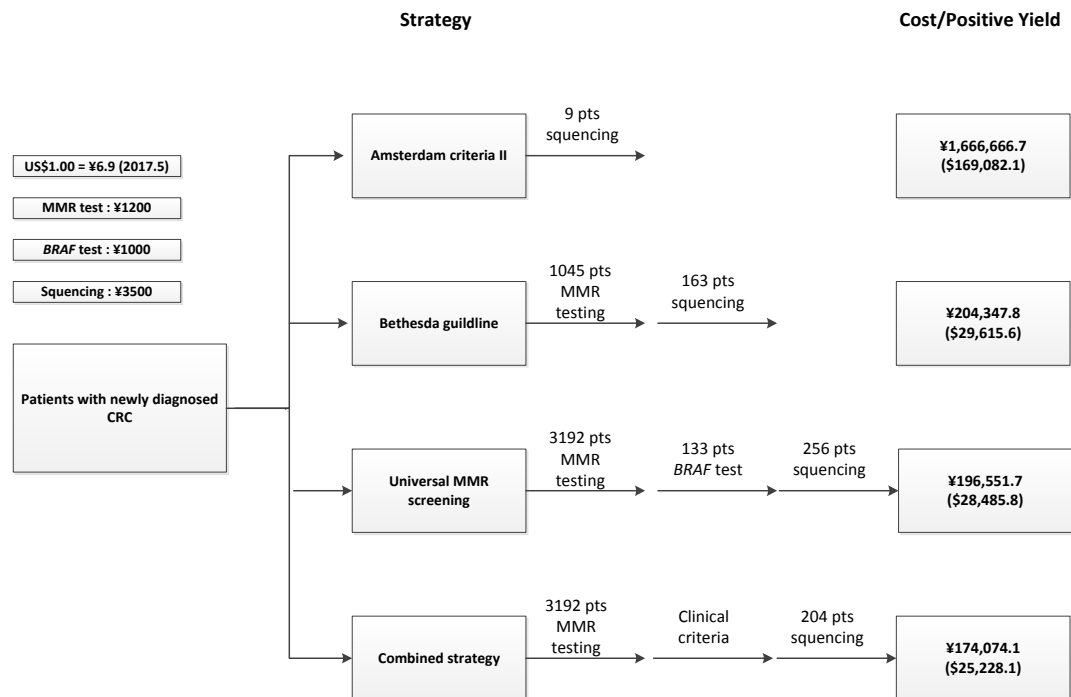

Fig. 4 Economic analysis for different strategies in indentifying patients with lynch syndrome (LS). The economic analysis was modeled based on the actual prevalence, positive yield of LS from our cohort (Table 1). For each branch in the figure, the number above the line represented the patients need for a certain test. The cost/positive yield means the expense for detecting one patients with LS in screening. Cost in China derived from the Medical Insurance Administration Bureau of Guangzhou, 2017. MMR, mismatch repair.

Screening pathways for Lynch syndrome: a systematic review of the existing pathways and a cost-effectiveness analysis in Italy.

Pastorino R¹, Michelazzo MB¹, Tognetto A¹, Di Marco M², Lucci-Cordisco E³, Villari P², Genuardi M³, Boccia S¹

¹ Section of Hygiene, Institute of Public Health, Università Cattolica del Sacro Cuore, Rome, Italy

² Department of Public Health and Infectious Diseases, Sapienza University of Rome, Rome, Italy

³ Institute of Genomic Medicine, A. Gemelli School of Medicine, Medical Genetics Unit, Università Cattolica del Sacro Cuore, Rome, Italy

Introduction

Lynch syndrome (LS) is an autosomal dominant disorder caused by mutations in the deoxyribonucleic acid mismatch repair genes. It accounts for about 2-3% of newly diagnosed cases of colorectal cancer (CRC), and is associated with the development of endometrial cancer and various other cancers. While the scientific knowledge about LS is increasing, the question about how LS related CRC should be prevented is still an open issue. The practice and recommendations about LS screening are very heterogeneous in Europe. The aim of this study is to assess the cost-effectiveness of different testing strategies to identify LS in the Italian context. Three steps were taken to achieve this aim: 1) systematic reviews of international guidelines, and existing screening pathways for LS 2) semi-structured interviews with Italian experts to identify the diagnostic pathways currently performed in Italy 3) cost-effectiveness analysis of the screening scenarios.

Methods

We searched for guidelines published from 2010 to 2016 on the provision of testing and management of patients at risk for and affected with LS, the pathways in place for LS identification, and the economic evaluations.

The cost-effectiveness analysis was performed from the Italian National Health Service perspective.

Results

Sixteen guidelines regarding the criteria for genetic referral and genetic test, and nine guidelines regarding prevention strategies were identified. There is an increasing indication to identify carriers of pathogenic variants starting from patients with CRC diagnosis. The seven screening pathways identified confirm this tendency, since most of them start from tumor tissue screening.

The cost-effectiveness analysis revealed that universal testing versus no testing is cost effective, but not necessarily in comparison with selective or age-targeted strategies.

Conclusions

This is the first economic evaluation on different testing strategies for LS in Italy. The results could affect the introduction of cost-effective recommendations for LS screening in Italy, following the international state of art.

NGS to investigate genetic predisposition to colon cancer in patients with colon cancer over inflammatory bowel disease.

Giuseppe Biscaglia, Anna Latiano, Stefano Castellana, Fabrizio Bossa, Daniela Scimeca, Annamaria Gentile, Tiziana Latiano, Giuseppe Corritore, Marianna Nardella, Giuseppina Martino, Tommaso Mazza, Angelo Andriulli and Orazio Palmieri

Inflammatory bowel diseases (IBD), ulcerative colitis (UC) and Crohn's disease (CD) represent an important risk factor in the development of colorectal cancer (CRC). The risk of CRC begins to increase 8 or 10 years after the diagnosis of IBD and strong evidences suggest that CRC occurs in the inflamed epithelium, according to the sequence dysplasia-carcinoma. To date, more than 200 genetic loci have been associated to IBD although none to the development of IBD related cancer. The aim of this study is to clarify the role of some oncogenes and protooncogenes in the molecular mechanism that leads IBD patients to CRC.

We profiled a panel of 9 genes (MLH1, MSH2, MSH6, PMS2, APC, MUTYH, TP53, STK11) and the most important gene associated to IBD (NOD2). A germline variant identification analysis pipeline was performed on the DNA of individuals with CRC diagnosis and IBD history. Data about patients' features, disease history, disease pattern, family history, and drugs were recorded. We ranked all identified germline mutations by pathogenicity and summarized the allelic frequencies of pathogenic variants and of those with uncertain clinical significance (VUS).

We identified 25 IBD patients all consecutively enrolled in a single referral center. The mean age at diagnosis of IBD was of 53 yrs (range 25-72), and a mean age at diagnosis of cancer of 62 yrs (range 36-72). Independently to the disease phenotype status, 6 pts (24%) resulted carriers of at least one major NOD2 susceptibility mutations (one compound heterozygotes) and further 3 rare variants.

Multigene panel testing identified 13 mutations in 12 IBD patients (48%); of these, 3 encompassing MLH1 gene, 4 MSH2, 4 APC and the remaining 2 the MUTYH gene. No mutations were identified in PSM2, TP53 and STK11 genes. Only in two cases (8%) the family history suggested a Lynch syndrome. In addition we detected a high number of potentially uninformative germline findings, including VUS.

This study demonstrates that a high rate of CRC in IBD patients is associated to high-penetrant mutations in mismatch repair and polyposis predisposition genes. Identifying gene carriers might be possible to stratify patients who need an intensive surveillance regimen or an early indication to prophylactic colectomy.

Do we still need surgery for treating small bowel polyps in Peutz-Jeghers Syndrome? A 13-years follow-up cohort

Elia Samaha¹, Sophie Scialom^{1,4}, Gabriel Rahmi^{1,4}, Guillaume Perrod^{1,4} Joel Ederly¹, Camille Savale¹, Charles-André Cuenod^{1,2,4} Jean-Marc Canard¹, Georgia Malamut^{1,4}, Pierre-Laurent-Puig^{1,3,4}, Christophe Cellier^{1,4}. On behalf of PRED-IdF Network.

1 – Gastroenterology and Endoscopy Unit, Georges Pompidou European Hospital. 20 rue Leblanc, 75015 Paris.

2 – Radiology Unit, Georges Pompidou European Hospital. 20 rue Leblanc, 75015 Paris.

3 – Oncogenetic department, Georges Pompidou European Hospital. 20 rue Leblanc, 75015 Paris 4 – Paris Descartes University, Paris

Aim

Polypectomy during enteroscopy is the first line treatment of small bowel (SB) polyps in Peutz-Jeghers syndrome (PJS). Our aim was to assess the need for surgery in a PJS cohort after joining a specialized screening network.

Material and methods:

Between 2002 and 2015, 25 PJS patients (F/M = 11/14, mean age=36, mean follow-up 60 months (2-139)), were screened every 2 to 3 years and polypectomy using device-assisted enteroscopy (DAE) was attempted each time a polyp > 1 cm was detected. In case of failure or incomplete resection, intra-operative enteroscopy (IOE) or surgical resection was performed.

Results

23/25 patients (92%) had 42 capsule endoscopies, and 14/25 patients (57%) had 23 magnetic resonance enterography (MRE) or computed tomography enteroclysis (CTE). A total of 50 DAE (42 per-oral and 8 per-anal) in all patients allowed the resection of 216 polyps. Endoscopic treatment was complete in 19/25 patients (76%). IOE was performed in another 4/25 patients (16%) allowing the resection of 58 polyps and a complete treatment in 92% of patients. SB surgical resection was finally indicated in 2/25 patients (8%), compared to 64% before screening (p<0,001).

Conclusion

DAE with IOE is sufficient in 92% of PJS patients for removing SB polyps. Surgical resection has become rare, but remains a good alternative for difficult cases.

Impact of an optimized colonoscopic screening program for patient with Lynch syndrome. Six years' results of a specialized French network.

Elia Samaha MD¹, Guillaume Perrod^{1,4}, Gabriel Rahmi MD, PhD^{1,4}, Christophe Bellanger MD^{1,4}, Sherine Khater MD¹, Leila Abbes MD¹, Camille Savale MD¹, Géraldine Perkins MD², PhD^{2,4}, Aziz Zaanani MD, PhD^{2,4}, Gilles Chatellier MD, PhD^{3,4}, Georgia Malamut MD, PhD^{1,4}, Christophe Cellier MD, PhD^{1,4}. On behalf of PRED-IdF Network.

1 Assistance Publique-Hôpitaux de Paris, Hôpital Européen Georges Pompidou, Service d'hépatogastro-entérologie et d'endoscopie, Paris, France.

2 Assistance Publique-Hôpitaux de Paris, Hôpital Européen Georges Pompidou, Service d'oncologie digestive, Paris, France.

3 Assistance Publique-Hôpitaux de Paris, Hôpital Européen Georges Pompidou, Unité d'Epidémiologie et de Recherche Clinique, Paris, France.

4 Faculté de médecine René Descartes, Paris, France

Introduction:

Despite colonic surveillance guidelines, colorectal cancer (CRC) occurrence remains frequent in patients with Lynch Syndrome (LS). Herein, we report the impact of an optimized screening program over a 6 years' follow-up period, from a specialized follow-up network (PRED-IdF).

Material and methods:

Patients with LS were proposed an optimized CRC screening program as follow: starting from the age of 20 years old, a complete colonoscopy with blue indigo carmin chromoendoscopy was scheduled every 2 years. In case of adenoma detection, the follow-up colonoscopy was reduced at one year. When the bowel preparation was not optimal (a Boston Bowel preparation scale <2 in any segment) or the colonoscopy was incomplete, the follow-up colonoscopy was rescheduled at 6 months. Data were collected retrospectively and prospectively. Retrospective colonoscopies were defined as colonoscopies performed before network inclusion. Optimal colonoscopy was defined as a colonoscopy fulfilling all the screening program follow-up criteria. Our main objective was to evaluate the quality of colonoscopies. Secondary objectives were the evaluation of the CRC detection rate (CDR), the adenoma detection rate (ADR) and the polyp detection rate (PDR).

Results:

From January 2010 to January 2016, 144 patients (M= 50, Median age = 50 +/-13 years old) with genetically confirmed LS (MLH1 = 39 %, MSH2 = 44%, MSH6 = 15%, PMS2 = 1%) were included. A total of 564 colonoscopies were analyzed, including 353 consecutive and 211 retrospective colonoscopies. After network inclusion, 98/144 (68%) patients had all their screening colonoscopies optimal vs 33/132 (25%) patients before inclusion ($p < 0,0005$). Optimal colonoscopy rate after inclusion was 304/353 (86%) vs 87/211 (41%) before, ($p < 0.0001$). The reasons for a non-optimal

colonoscopy were: delayed colonoscopies 20/49 (40.8%), absence of indigo carmin chromoendoscopy 16/49 (32.7%) or both 13/49 (26.5%). Interval CRC was significantly reduced after Network inclusion (1/353; 0.3%) vs before (6/211; 2.8%) ($p=0.012$). ADR was 97/353 (27.4%) after vs 61/211 (28.9%) before inclusion ($p>0.05$) whereas PDR was 167/353 (47%) after vs 90/211 (43%) before inclusion ($p>0.05$), with no significant difference.

Conclusion:

An optimized colonoscopy follow-up program in LS patients improves colonoscopic screening quality, and may thus decrease colorectal interval cancer occurrence. Long term cohort studies are needed to confirm these results.

CASP5 (-1) frameshift mutation in microsatellite unstable colorectal cancers is associated with less good prognosis, but could be targeted by efficacious anti-tumor cytotoxic T lymphocytes.

Estelle Dupel¹, Hafid Kora¹, Sami Gouas¹, Pauline Maby¹, Alexandre Couture¹, Jacques Mauillon², Nathalie Parodi², Jérôme Leprince³, Thierry Frebourg^{1, 2}, Jean-Baptiste Latouche^{1, 2}

¹Inserm U1245, Institute for Research and Innovation in Biomedecine (IRIB), Rouen Normandy University, Rouen, France; ²Department of Genetics, Normandy Centre for Medical Genomics and Personalized Medicine, Rouen University Hospital, Rouen, France; ³Inserm U1239, IRIB, Rouen Normandy University, Mont-Saint-Aignan, France

Colorectal cancers (CRCs) with microsatellite instability (MSI) represent around 15% of all CRCs. These CRCs are linked to a defect in DNA mismatch repair machinery, and to the accumulation of mutations in DNA repeat sequences, including frameshift mutations (FSMs) in coding repeat sequences. These FSMs can lead to the synthesis of immunogenic neoantigens, presented as neopeptides on HLA class I molecules expressed by mutated tumor cells, and potentially targeted by specific cytotoxic T lymphocytes (CTLs).

To detect tumor FSMs in MSI CRC patients, we designed three multiplex PCRs amplifying 32 coding repeat sequences in 29 genes. We then looked for correlations between FSMs and patient survival. Finally, to activate specific CTLs *in vitro*, we constructed artificial antigen presenting cells (AAPCs) efficiently presenting, on HLA-A*02.01 (A2.1), the most frequent HLA class I molecule, a transgene-encoded peptide or peptides derived from a transgene-encoded full length protein.

We first showed on a cohort of 71 MSI CRC patients that *CASP5* (-1) FSM was frequently present in the tumors (around two-thirds of all MSI CRCs) and that this mutation was associated with a less good prognosis ($p < 0,05$). This single nucleotide deletion in *CASP5* gene could lead to the synthesis of an immunogenic *CASP5* mutated protein, and two neopeptides, FSP25 and FSP26, derived from this neoantigen, were predicted to be presented on the HLA-A2.1 molecule. A2.1⁺ AAPCs expressing each one of these neopeptides or the full length *CASP5* mutated protein could stimulate and expand FSP-25- and FSP-26-specific peripheral CTLs from HLA-A2⁺ MSI CRC patients whose tumor cells harbored the mutation. Importantly, anti-tumor activity of activated CTLs was ascertained by specific lysis of HLA-A2.1⁺ MSI CRC cell line HCT116 harboring the same *CASP5* (-1) FSM.

These preclinical data suggest that FSM-derived neoantigens could be targeted in new personalized specific immunotherapy strategies. From this perspective, *CASP5* (-1) FSM, associated with a less good prognosis in MSI CRCs, might be of major interest, especially for young patients with Lynch syndrome, the most common cause of hereditary CRCs.

Keywords: neoantigen, neopeptide, caspase 5, cytotoxic T lymphocyte, artificial antigen presenting cell

Combined RNA and protein analyses contribute to the interpretation of exonic variants identified in Lynch syndrome patients

Omar Soukariéh¹, Lucie Grodecká², Nicole Köger³, Thierry Frébourg^{1,4}, Guido Plotz⁵,
Alexandra Martins¹

¹Inserm U1245, UNIROUEN, Normandie Univ, Normandy Centre for Genomic and Personalized Medicine, Rouen, France

²Molecular Genetics Laboratory, Centre for Cardiovascular Surgery and Transplantation, Brno, Czech Republic

³Biomedical Research Laboratory, Department of Internal Medicine 1 and Department of Human Genetics, Universitätsklinikum Frankfurt, Frankfurt D-60590, Germany, Institute of Human Genetics, University of Bonn, Bonn D-53127, Germany

⁴Department of Genetics, University Hospital, Normandy Centre for Genomic and Personalized Medicine, Rouen, France

⁵Medizinische Klinik 1, Biomedical Research Laboratory, University of Frankfurt, Frankfurt, Germany

With the implementation of high-throughput sequencing in Oncogenetics, the challenge is no longer the detection of germline or somatic changes in patients' DNA but their biological and clinical interpretation. This is a key problem, especially: (i) in exome analyses, where thousands of variations are typically identified per individual, as well as (ii) in the context of targeted sequencing of genes with large mutational spectra, such as *MLH1* and *MSH2* implicated in Lynch syndrome. Recently, we showed that exonic splicing mutations are more prevalent than initially estimated and can be predicted by using new bioinformatics tools (Soukariéh *et al.*, 2016). Here again, we used *MLH1* exon 10, as a model system to evaluate the pertinence of using complementary approaches for improving the interpretation of Variants of Unknown Significance (VUS). We resorted to bioinformatics and experimental methods to evaluate consequences both at the RNA and protein levels.

First, 6 new variations identified in *MLH1* exon 10 were analyzed for their effect on exonic splicing regulatory elements (ESR) by using *in silico* approaches and minigene splicing assays, thus extending our previous work. We then further investigated all not-yet-fully-characterized missense variants in this exon (n=11) by performing protein-dedicated bioinformatics analyses and experimental tests, the latter allowing to assess protein expression and activity. Finally, bioinformatics data obtained for all *MLH1* exon 10 variants (n= 28) were compared with experimental results, making this work, to our knowledge, the most comprehensive functional study on a particular exon of a Lynch syndrome susceptibility gene.

Our findings show that the new ESR-dedicated bioinformatics tools reliably predict the impact on splicing of the new *MLH1* exon 10 variants, which agrees with our previous work and indicates that these *in silico* methods help stratifying variants for experimental analyses. In contrast, and according to the results of the protein functional tests, the protein-dedicated *in silico* tools showed poor predictive power, as they could not correctly distinguish deleterious (n=5) from non-deleterious (n=15) missense variants.

This study emphasizes the importance of combining RNA and protein functional data to better interpret variations identified in Lynch syndrome patients, and provides conceptual and methodological clues potentially applicable to the interpretation of any variation identified by exome sequencing.

Selected topic: Genetic Diagnosis

Extra-colonic cancer risks in *PMS2* associated Lynch syndrome.

S.W. ten Broeke(1), H.M. van der Klift(1), C.M.J. Tops(1), S. Aretz, I. Bernstein(2), D. Buchanan(3), I. Cheng(4), M. Clendenning(3), G. Capellá Munar(5), C. Engel(6), S. Gallinger(7), E. Gomez Garcia(8), J.C. Figueiredo(9), N. Hoogerbrugge(10), L. Le Marchand(11), T.G.W. Letteboer(12), M. Jenkins(3), A. Lindblom(13), N. Lindor(14), A.R. Mensenkamp(10), P. Moller(15), P.A. Newcomb(16), Th. A. van Os(17), R. Pearlman(18), M. Pineda(5), N. Rahner(19), E.J.W. Redeker(17), M. Olderode-Berends(20), C. Rosty(3), R. Scott(21), L. Spruijt(10), L. Senter(18), M.Suerink(1), Y.J. Vos(20), A. Wagner(22), F.J. Hes(1), H.F. Vasen(1), J.T. Wijnen(1), M. Nielsen(1), A.K. Win(3)

1. Leiden University Medical Center, Leiden, The Netherlands
2. Aalborg University, Aalborg, Denmark
3. University of Melbourne, Melbourne, Australia
4. Northern California Colon Cancer Family Registry/Cancer Prevention Institute of California Fremont, California
5. l'Hospitalet de Llobregat, Spain
6. Leipzig University, Leipzig, Germany
7. Ontario Familial Colorectal Cancer Registry (OFCCR)/ Mount Sinai Hospital, Toronto, Ontario, Canada
8. Maastricht University Medical Center, Maastricht, The Netherlands
9. Cedars-Sinai Medical Center Consortium/ University of Southern California, Los Angeles, California, United States
10. Radboud University Medical Center, Nijmegen, The Netherlands
11. Hawaii Family Registry of Colon Cancer/ University of Hawaii at Manoa, Manoa, Hawaii
12. University Medical Center, Utrecht, The Netherlands
13. Karolinska University Hospital, Solna, Sweden
14. Mayo Colorectal Cancer Family Registry/ Mayo Clinic Scottsdale, Arizona, United States
15. Oslo University Hospital, Oslo, Norway
16. Seattle Familial Colorectal Cancer Registry/ Fred Hutchinson Cancer Research Center Seattle, Washington, United States
17. Academic Medical Center, Amsterdam, The Netherlands
18. Ohio State University, Ohio, United States
19. University of Dusseldorf, Dusseldorf, Germany
20. University Medical Center Groningen, Groningen, The Netherlands
21. University of Newcastle, Newcastle, Australia
22. Erasmus Medical Center, Rotterdam, The Netherlands

Introduction. Lynch syndrome is traditionally characterized by high frequencies of colorectal (CRC) and endometrial cancer (EC). However, the tumor spectrum also includes other cancers. Data on these less frequent cancers is limited for *PMS2* associated Lynch syndrome. A previous study by our group in 98 European *PMS2* families identified significantly increased standardized incidence ratios (SIRs) for cancer of the small bowel, ovaries, renal pelvis and -notably- breast cancer. Cumulative risks for these less frequent cancers were not estimated due to limited power. We now aim to establish these risks after collaboration with other groups, including the Colon Cancer Family Registry (CCFR).

Methods. Missing ages at cancer diagnosis will be imputed by using population median ages. Cumulative cancer risks will be estimated with a modified segregation analysis, to correct for ascertainment bias.

Results. We collected 285 families (table 1) with a segregating pathogenic *PMS2* mutation. Statistical analyses are currently being carried out and are expected shortly.

Discussion. Previous studies have shown a markedly lower penetrance of colorectal and endometrial cancer in *PMS2* mutation carriers. The current work will give insight in other Lynch associated cancers and will provide handles for clinical management. It will also shed light on the possibility of an moderately increased risk (SIR 3.8 in previous study) of breast cancer for female *PMS2* carriers, which could lead to an additional surveillance advice.

Family members	9735
Male (%)	4838 (49.7%)
Confirmed mutation carriers	878
Total number of families	285
Australia	25
Canada	8
Germany	53
Netherlands	103
Northern Europe (Denmark, Sweden, Norway)	28
Spain	6
USA	62

Analysis of patient mutations and knockout variants on *MUTYH* expression

Nicole Köger, Inga Hinrichsen, Angela Brieger, Stefan Zeuzem, and Guido Plotz
(Biomedizinisches Forschungslabor, Medizinische Klinik 1 Universitätsklinikum Frankfurt, Germany)

One third of all colorectal cancers (CRC) have a hereditary background, and *MUTYH* associated polyposis (MAP) accounts for around 1% of CRC cases with a well defined genetic basis. Biallelic germline mutations in the DNA repair gene *MUTYH* can result in the inactivation of this gene, leading to somatic mutations in target genes and colorectal polyposis. The DNA glycosylase *MUTYH* is involved in the correction of mismatches resulting from a faulty base pairing of 8-hydroxyguanine (8-oxoG) with adenine. For that reason, tumors of MAP patients bear distinctive somatic GC>TA transversion mutations.

The *MUTYH* gene shows strong alternative splicing, generating multiple transcript variants encoding different protein isoforms which are either targeted to mitochondria or to the cell nucleus. We have found before that the alternative expression of the *MUTYH* gene is tissue-specific: the transcripts encoding protein isoforms that are targeted to cell nuclei are generated primarily in proliferating tissues, while transcripts encoding mitochondrial isoforms predominate in muscle cells (Plotz et al. 2012). However, it is not currently known how this differential expression is regulated.

Several genetic alterations have been identified in humans (cancer patients or controls) affecting the 5' region of the *MUTYH* gene, which contains the promoter(s) that regulate *MUTYH* transcript expression, and the impact of these single nucleotide alterations on the control of the alternative transcription of the gene has not yet been investigated. We therefore developed a method for identifying relevant regulatory sequence motifs and testing human variants of the 5' gene region.

For that purpose, we generated a minigene capable not only of correct exon splicing, but also of conferring expression by its endogenous promoter sequences. The gene contained the putative promoter region of *MUTYH* including the transcriptional start positions of the alternative transcripts, as well as the first exons. We demonstrated the functionality of this experimental model and studied the effect of patient mutations. We assessed the conservation of the *MUTYH* promoter region and introduced knockout variants of highly conserved promoter areas into the minigene. We present our results on the transcriptional regulation of the *MUTYH* gene and the effects of human variants, giving insight into the function of its promoter and simultaneously providing a map of essential elements of the promoter that are sensitive to mutational changes.

Plotz G., Casper M., Raedle J., Hinrichsen I., Heckel V., Brieger A., Trojan J., and Zeuzem S.:
MUTYH gene expression and alternative splicing in controls and polyposis patients.
Hum Mutat. (2012): 33(7):1067-74.

Spontaneous remission of metachronous neoplastic lesions in a Lynch syndrome patient: efficient immune reaction deciphered by modern medicine?

Basso G¹ Carnaghi C², Rahal D³, Bossi P³, Lugli E⁴, De Paoli F⁴, Bianchi P¹, Malesci A⁵, and Laghi L^{1,5}.

1Laboratory of Molecular Gastroenterology

2 Oncology Dept.

3 Surgical Pathology

4 Laboratory of Translational Immunology

5 Gastroenterology Dept.

of Humanitas Clinical and Research Center

Mrs T.M., a 62 years old patient with Lynch syndrome (LS), developed 4 metachronous cancers during her life, encompassing a gastric cancer, metachronous colorectal cancers, and an endometrial cancer. Following the molecular diagnosis of LS, she entered in a surveillance program. Thereafter, she developed the endometrial cancer (FIGO-I), followed by multifocal right colon cancers (pT1N0M0). Following resection of the latter tumors, she became strictly adherent to surveillance, during which abdominal ultrasound revealed multifocal liver lesions, confirmed by CT scan. Blood tests were within normal ranges, but for CA19.9 levels. Upper and lower gastrointestinal endoscopies were negative, but liver biopsy was consistent with adenocarcinoma. Considering the low metastatic potential of LS tumors, a diagnosis of multifocal liver cancer, possibly arising from the biliary tree, was achieved. The lesion pattern precluded any surgical approach, raising the issue of an appropriate chemotherapy regimen. Ultimately, PET detected no primary sites, but also no hyper-metabolic liver lesions. Further CTs showed progressive reduction in the extent of the liver lesions, up to their disappearance, in the absence of any medical intervention. To our knowledge, this is the first documented report of spontaneous cancer remission in a patient with full-blown LS, within a dedicated program. Due to the high immunogenicity of tumors in LS patients, we hypothesize that this unexpected observation can be linked to progressive immunization towards unstable cancers, leading to immune rejection of the tumor, resembling an abscopal effect or collateral immunity. Molecular studies to clarify the basis of this unique observation are underway.

Study of rare variants in mismatch-repair genes in Slovak population using data from whole genome test for pregnant women

Szemes, T.^{1,2,3}; Strieskova L.^{1,3}; Frno, R.³; Tomanova N.¹; Budis J.³

¹Faculty of Natural Sciences, Comenius University, Bratislava

²University Science Park, Comenius University, Bratislava

³Geneton Ltd., Bratislava

The incidence of colorectal cancer in Slovakia is one of the highest worldwide. No systematic studies are carried out to determine contributing genetic and environmental factors due to limited support of basic research. Our laboratory developed own implementation of non-invasive prenatal test (NIPT) which allows detection of fetal chromosomal aberrations. It is carried out by low coverage whole genome sequencing using massively parallel sequencing. As such, it also allows to determine genetic variation at single nucleotide level. Due to low coverage, it has limited use for individuals sequenced, but aggregated data with appropriate analysis pipeline allows determination of allelic frequencies in population as well as identification of rare, potentially pathogenic SNV virtually in any gene of interest. We attempted to determine incidence of rare, potentially pathogenic variants in genes MLH1, MSH2, MSH6 and PMS2 to study frequency of rare variants implicated in Lynch syndrome. Thus we wanted to determine if Lynch syndrome has similar or higher incidence in Slovak population. Aggregating data from 500 healthy pregnant women undergoing NIPT, we were able to identify 8 SNV which were annotated as pathogenic or likely pathogenic variants in InSight database. In addition, we identified over 80 additional nonsynonymous or stopgain variants which were not defined in the dbSNP database but which had a possible damaging effect based on SIFT, Polyphen2, GERP++ or phyloP calculated values. Currently verification of these variants by Sanger sequencing is carried out in our laboratory.

Haplotype association analysis of cancer risk susceptibility in a Swedish population

Wen Liu¹, Xiang Jiao¹, Jessada Thutkawkorapin¹, Hovsep Mahdessian¹, **Annika Lindblom¹**

1. Department of Molecular Medicine and Surgery, Karolinska Institutet, SE-171 76 Stockholm, Sweden

Abstract

Most cancer syndromes confer an inherited predisposition to several different cancer types. To find support for further loci with a genetic contributing to multiple cancers as a whole, a case-control study using 3555 cancer cases and 15581 controls was genotyped for 226,883 SNPs.

Haplotypes describe the linear relationship of a series of loci along the chromosome strand. A sliding window haplotypes analysis consist of different sets of contiguous loci at various sliding positions. Sliding window sizes 10 and 25 were conducted on this study. The statistical analysis revealed seven loci with cancer association in which six of the loci revealed cancer risk association (all with $p \leq 1.1 \times 10^{-7}$) (Table 1). The haplotype for the locus chromosome 21 had an odds ratio of 0.407, which cannot be used to study the risk patients. The haplotypes around these 10 or 25 markers were tested to see if it was possible to more support for a founder risk haplotype of these loci. This analysis confirmed the loci but did not substantially change the result. Six of the haplotypes were associated with an increased cancer risk and one with a decreased cancer risk (Table 2).

Then the haplotypes from 104 patients (from 58 breast cancer families and 46 CRC families) were compared with the six risk haplotypes. Seven families had family members with the haplotypes on chromosomes 7, 14, 16 and 17 (Figure 1). Family 242 (Co-666) and family 397 (Co-1026 and Co-1123) had the suggested locus on chromosome 7, family 87 (Co-1179 and Co-1318) and family 1275 (Al-76 and Al-77) the locus on chromosome 14, family 134 (Co-276 and Co-460) the locus on chromosome 16, and family 288 (Co-1141) and family 2606 (Al-161) the locus on chromosome 17. For other family members, the haplotypes were not fully informative but suggested that there were more patients with all six haplotypes (Supplemental table 1).

This study could report seven novel candidate loci showing specific haplotypes segregating in Swedish cancer families to be associated with an increased risk of cancer. We hypothesized that using haplotype analysis rather than single SNP analysis would give a better chance to define a Swedish founder risk haplotype.

Figure Legends

Fig. 1 Pedigrees

Pedigrees for the seven families with the risk-haplotypes, after family ID is given the matching haplotype for each family. Re: Rectal Cancer; Ga: Gastric Cancer; Br: Breast Cancer; Ca: Cancer; Co: Colon Cancer; Leu: Leukemia; Lym: Lymphoma; H/N: Head and Neck Cancer; Mel: Melanoma; Pr: Prostate Cancer.

Table 1. Risk loci in Seven chromosomes

Chromosome	Window Size	SNPs	Position (GRCh37.p13)	Best Window Size	SNPs	Position (GRCh37.p13)	OR	P Value
1	10	rs1891243 — rs880496	224687445-224808134	7	rs7550648 — rs883115	224707177-224807561	1.68	6.29E-07
7	25	rs2078176 — rs534126	142356859-142921234	25	rs2078176 — rs534126	142356859-142921234	1.9	3.03E-07
11	10	rs971535 — rs11602836	23145520-23232884	10	rs971535 — rs11602836	23145520-23232884	1.61	6.13E-07
14	10	rs9323205 — rs12432203	51586467-51710861	8	rs3007168 — rs12432203	51608293-51710861	1.56	2.25E-07
16	25	rs7546 — rs2908668	4847317-5073773	25	rs7546 — rs2908668	4847317-5073773	1.83	3.01E-07
17	10	rs4794031 — rs7502499	47342153-47490102	10	rs4794031 — rs7502499	47342153-47490102	1.35	7.27E-07
21	25	rs2834439 — rs2284576	35672918-35914812	31	rs2834439 — rs2251817	35672918-35934476	0.407	3.04E-07

Selecting regions for haplotype association analysis results. Seven loci showed good cancer risk association, which the p-value closed to $P < 1.1 \times 10^{-7}$, and also showed the expanded window sizes of these seven loci.

Table 2. Seven best haplotypes

chr1		chr7		chr11		chr14		chr16		chr17		chr21	
SNPs		SNPs		SNPs		SNPs		SNPs		SNPs		SNPs	
rs7550648	C	rs2078176	A	rs971535	C	rs3007168	G	rs7546	C	rs4794031	T	rs2834439	G
rs712068	A	rs6975391	C	rs11027001	C	rs10138053	C	rs8064024	A	rs11079867	A	rs4817642	A
rs16841702	T	rs17837474	G	rs7115663	T	rs7148539	C	rs12444795	C	rs2898857	G	rs2834440	A
rs6426142	C	rs17837475	T	rs4472938	G	rs2999393	G	rs1395602	A	rs1343795	A	rs2834450	A
rs4654049	T	rs6968949	C	rs10160246	A	rs12588488	C	rs8064029	C	rs7225787	A	rs2834461	C
rs1532557	C	rs6946770	A	rs11828289	T	rs12431939	G	rs6500637	T	rs16948048	A	rs723548	G
rs883115	C	rs17251	C	rs16910800	T	rs7149337	T	rs2251666	G	rs11655704	C	rs13048252	A
		rs6959895	T	rs17234274	A	rs12432203	A	rs4038782	T	rs2584663	G	rs10854373	C
		rs10273639	T	rs10833965	A			rs1029966	T	rs2197159	T	rs2834475	A
		rs2367486	A	rs11602836	C			rs11861717	C	rs7502499	G	rs2834478	T
		rs12539089	C					rs1468734	G			rs8129326	G
		rs11327	T					rs9635542	A			rs2834485	G
		rs3134906	G					rs3852764	T			rs3453	T
		rs4281045	C					rs9935441	G			rs2070359	A
		rs7805607	T					rs9940799	C			rs2247810	T
		rs17163745	A					rs11864122	C			rs4817656	C
		rs2063993	G					rs7191632	C			rs11911509	C
		rs4987668	A					rs11641901	G			rs2211698	G
		rs4252435	G					rs11640939	C			rs7279771	C
		rs4252416	A					rs2908689	A			rs727957	G
		rs4252381	G					rs12596115	A			rs2834502	T
		rs17164103	C					rs717344	A			rs8131131	C
		rs1506403	C					rs6500650	C			rs2834506	A
		rs9986765	A					rs1558562	A			rs2834512	G
		rs534126	C					rs2908668	G			rs2284576	G
												rs2251280	G
												rs8129311	C
												rs8126847	T
												rs8134785	C
												rs2834541	A
												rs2251817	T

Seven risk loci's haplotype.

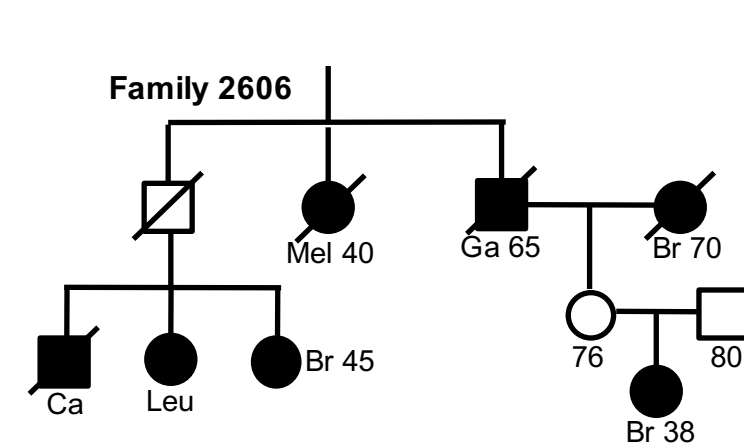
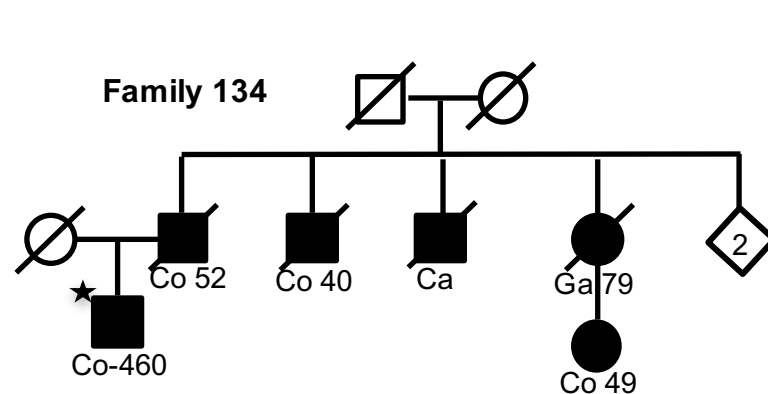
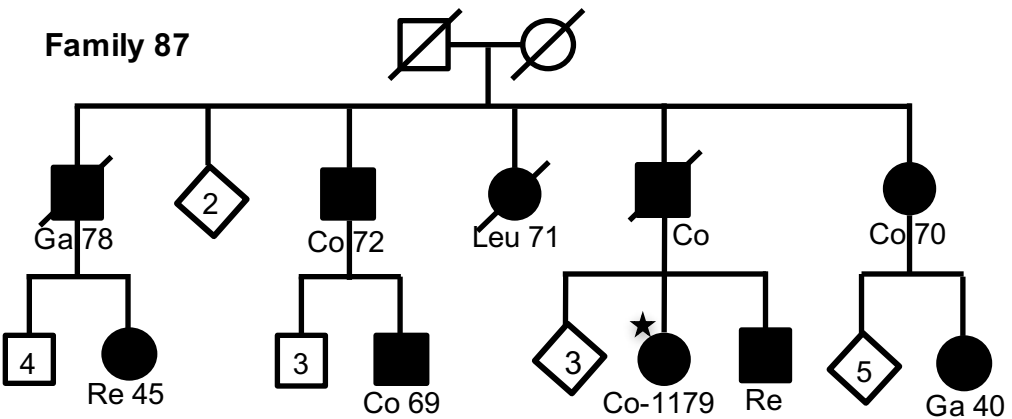
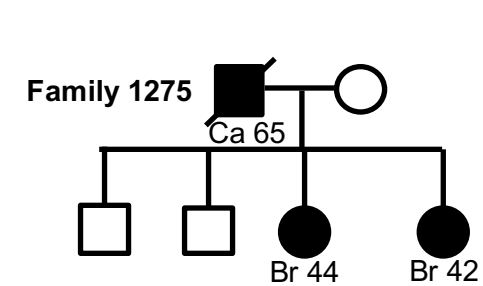
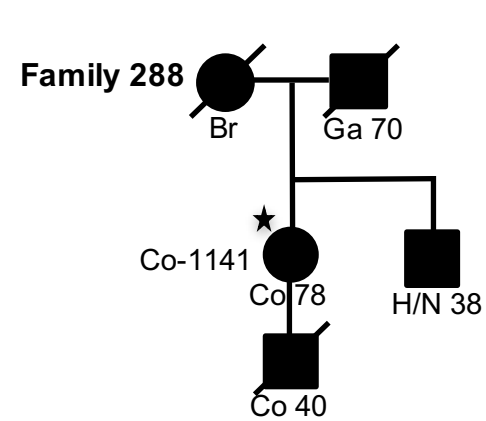
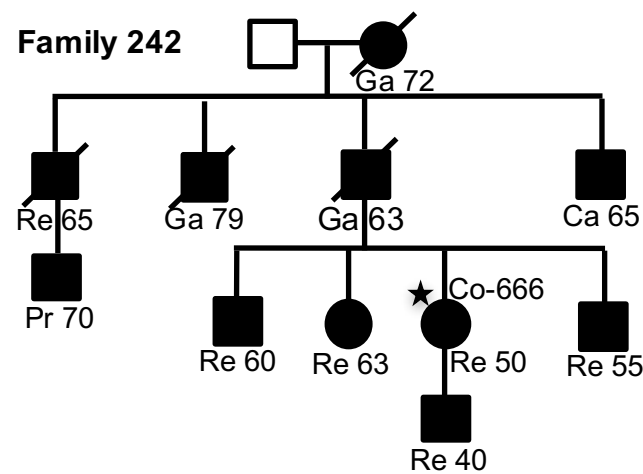
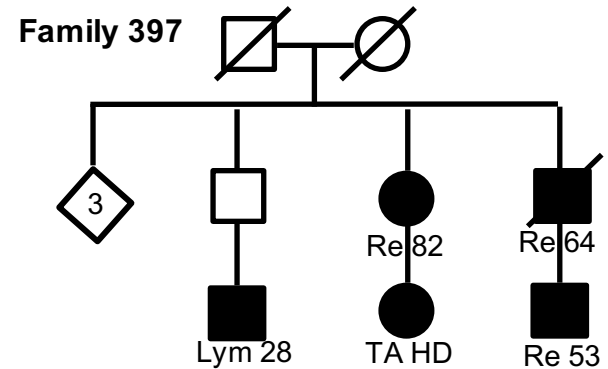

Supplemental table 1. Familial germline DNA samples matching the six risk haplotypes

		chr1	chr7	chr11	chr14	chr16	chr17
Family members with fully matched haplotypes	CRC		397: Co-1026, Co-1123 242: Co-666		87: Co-1179 , Co-1318	134: Co-276 , Co-460	288: Co-1141
	Breast cancer				1275: Al-76 , Al-77		2606: Al-161
Family members with suggested but incomplete haplotypes	CRC	409: Co-1254	91: Co-454, Co-700 301: Co-837, Co-1053 , Co-1796 325: Co-851 , Co-860	155: Co-557 208: Co-1094 288: Co-1248, Co-1141 409: Co-1254	12: Co-90 103: Co-649, Co-257 155: Co-557 , Co-619 216: Co-367 , Co-1095 227: 294-89D , Co-365 , Co-364 237: Co-1267, Co-452 547: Co-1621 , Co-1316 1085: Co-1508, Co-1518	103: Co-649, Co-257 309: Co-783 397: Co-1206, Co-1123 547: Co-1621 , Co-1316	12: Co-90 , Co-1662 68: Co-201 , Co-675 309: Co-783 340: Co-831 660: Co-1599
	Breast cancer	179: Al-22 , Co-323 4001: Br-48 , Br70 4038: Br-58, Br-53 6002: Co-326, Co-328 6039: Br-312 , Br-311 6080: Br-409 , Br-410	1227: Al-170 , Al-169	1898: Al-92 5020: Br-114 , Br-117 6002: Co-326, Co-328 6039: Br-312	1505: Al-111 , Al-168 3006: And31, And23 3009: ING31 , ING23 4038: Br-58, Br-53 5042: Br-184, Br-183 6022: Br-289 , Br-288 6082: Br-411, Br-419 6089: Br-432 6103: Br-499	1275: Al-76 , Al-77 2606: Al-161 6050: Br-331 , Br-330 6076: Br-399	79: Al-65 , Al-56 1227: Al-169 1898: Al-92 2101: Al-176 , Al-153 6106: Br-484 , Br-504

11 patients among 7 families showed well matched haplotypes in four of the risk loci (on chromosome 7, 14, 16 and 17) while also have some more families showed incomplete haplotypes since their haplotypes were not fully informative. Sample ID's in bold are indel patients used for haplotyping.

Thanks to

LS CancerDiag

